

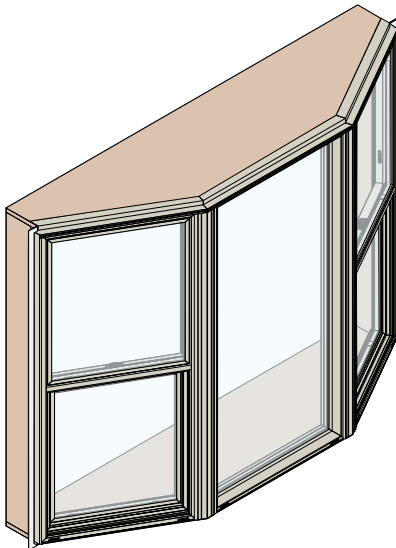

Thank you for selecting JELD-WEN products. Attached are JELD-WEN's recommended installation instructions for Vinyl Bay/Bow windows with an integral nail fin. Not all window types may be installed into every wall condition in all areas. Consult your local building code official for applicable building codes and regulations. Local building code requirements supersede recommended installation instructions. Areas such as Florida and the Texas TDI region have different anchoring requirements based on product certification. For information on specific products, visit www.floridabuilding.org or www.tdi.texas.gov and follow the anchoring schedule given in the drawings for the product instead of the anchoring schedule in this document.

Bay



Bow

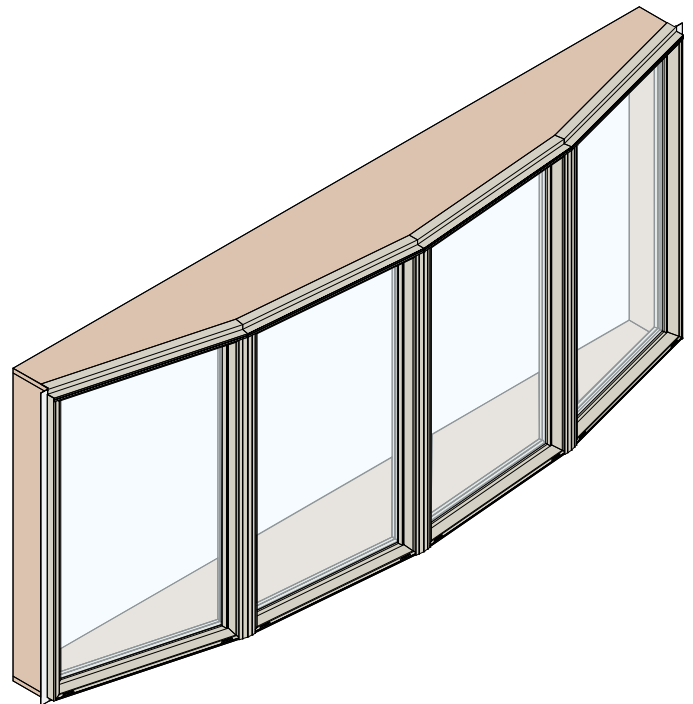

7 STEP INSTALLATION STICKER

The 7 Installation Steps below are included with the product:

- 1. Inspect Product:** Products should be inspected for shipping damage, color, configuration, handing, etc. Additionally, inspect products for any manufacturing anomalies prior to installation (e.g. warp, bow, squareness). Contact Dealer or JELD-WEN if issues are identified.
- 2. Install Rough Opening (R.O.):** Inspect R.O. prior to installation of the product. Correct any deviation that would prevent the window/door product from being installed plumb, level, square and without twist.
- 3. Install Sill Pan:** A sill pan is **required** prior to window/door product installation (refer to the latest version of **ASTM 2112** for sill pan definitions). Sill pan should have a positive slope and must be installed onto the sill of the R.O. in a weather-tight manner and able to drain to the exterior. For aftermarket sill pans, such as SureSill™, follow manufacturer's instructions. For sill pans without a positive slope, place 1/4" tall plastic shim 2" from each corner and no more than 8" on-center in between **(excludes Canada)**.
- 4. Temporarily Fasten and Shim Product:** Position window/door product into R.O. and apply a screw through-frame/fin at an upper corner. Verify product is level. Add shims along the sides and head to make product square, plumb and without twist (min. of 3 shims per side – top, bottom, middle).
- 5. Fasten Product (Size and Spacing):** Unless specified by instructions or code, most products should be secured with a #8 pan-head (or larger diameter head), corrosion-resistant screw; embedment must be a minimum of 1 1/4" into the structural framing. Place a shim at each through-frame screw location. **NOTE:** Florida, Texas and other jurisdictions may have additional requirements – **check local code**. Additionally, folding nail fins and some exterior trim options are not structural, so through-frame fastening is required. See installation instructions for screw size and spacing. As a default, screw spacing is 4" from corners and 8" on-center.

6. Install Drip Cap: The use of a drip cap on all window/door products is recommended, regardless if supplied. A drip cap is **required** on any **vertical** mulled/joined products, regardless if supplied. **NOTE:** A drip cap may not be suitable for some product lines (e.g. brickmould vinyl, flush fin, vinyl flat casing, various wall systems), regardless these product lines need to be incorporated into the wall in a weather-shedding manner.

7. Create "Interior" Air Seal: A "continuous" interior air seal is **required** (use low expansion window-door foam or backer rod and sealant) between the window/door frame and the R.O. framing (jamb extension is not to be considered part of the frame). An air space should remain between the nail fin/exterior sealant joint and the interior air seal.

NOTE: Shims may need to be cut back, so the interior air seal is "continuous" between the window/door frame and rough opening. Additionally, some wall systems may not allow for the application of an interior air seal.

Weather Proofing of the Rough Opening (R.O.) and/or Product is the responsibility of the Installer: JELD-WEN recommends the use of industry-recognized flashing systems, such as OSI (www.ositough.com) or other professional sources.

NOTE: It is the responsibility of the Owner, Architect or General Contractor to select products in compliance with applicable laws and building codes.

These 7-steps serve as the basic/default steps during the installation process and are in conjunction with the following installation instructions, which better refine fastener spacing, shimming, fastener location, additional information on applying loose parts/components, product handling/storage and all other product related aspects/considerations, found at www.jeld-wen.com.

IMPORTANT INFORMATION | TABLE OF CONTENTS | GLOSSARY

PLEASE NOTE: Installations where the sill is higher than 35 feet above ground level, or any product installation into a wall condition not specifically addressed in these instructions, must be designed by an architect or structural engineer. Failure to install windows into a square, level, and plumb openings could result in denial of warranty claims for operational or performance problems.

NOTE TO INSTALLER: Provide a copy of these instructions to the building owner. By installing this product, you acknowledge the terms and conditions of the limited product warranty as part of the terms of the sale.

Table of Contents

[Safety and Handling](#)3
[Materials and Tools](#)4
[Inspect Product](#)4
[Inspect Rough Opening \(R.O.\)](#)5
[Install Sill Pan](#)6
[Temporarily Fasten and Shim Product](#)6
[Fasten Product \(Size And Spacing\)](#)7
[Install Drip Cap](#)7
[Create “Interior” Air Seal](#)8

Glossary

Mull Joint

The joint where two or more window units are structurally joined together.

Mulled Unit

Two or more window units structurally joined together.

Self-Adhered Flashing

An adhesive backed tape material used to waterproof the rough opening and/or used to seal a window to the building’s weather barrier.

Shiplap

The layering method in which each layer overlaps the layer below it so that water runs down the outside.

Weep Hole (weep channel)

The visible exit or entry part of a water drainage system used to drain water out of a window.

SAFETY AND HANDLING

Safety

- Read and fully understand **ALL** manufacturers’ instructions before beginning. Failure to follow proper installation instructions may result in the denial of warranty claims for operational or performance problems.
- **DO NOT** work alone. **Two or more people are required.** Use safe lifting techniques.
- Use caution when handling glass. Broken or cracked glass can cause serious injury.
- Wear protective gear (e.g. safety glasses, gloves, ear protection, etc.).
- Operate hand/power tools safely and follow the manufacturer’s operating instructions.
- Use caution when working at elevated heights.
- If disturbing existing paint, take proper precautions if lead paint is suspected (commonly used before 1979). Your regional EPA (www.epa.gov/lead) or Consumer Product Safety Commission offices provide information regarding regulations and lead protection.

Window Handling

- Make sure operable windows are locked prior to installation.
- Heed material manufacturers’ handling and application instructions.
- Handle in a vertical position; **DO NOT** carry flat or drag on the floor.
- **DO NOT** put stress on joints, corners or frames.
- Store window in a dry, well-ventilated area in vertical, leaning position to allow air circulation; **DO NOT** stack horizontally.
- Protect from exposure to direct sunlight during storage.
- Install only into vertical walls and when conditions and sheathing are dry.

IF INJURY OCCURS, IMMEDIATELY SEEK MEDICAL ATTENTION!

⚠️ WARNING

Drilling, sawing, sanding or machining wood products can expose you to wood dust, a substance known to the State of California to cause cancer. Avoid inhaling wood dust or use a dust mask or other safeguards for personal protection. For more information, go to www.P65Warnings.ca.gov/wood.

MATERIALS AND TOOLS

JELD-WEN exterior window and door products should be installed in accordance with JELD-WEN's recommended installation instructions, which are printed on the product label or can be found on our website: www.jeld-wen.com. **NOTE:** When using flashing, spray adhesive/primer, sealant and foam products, we recommend using the same manufacturer and verifying compatibility. It is the End User's responsibility to determine if dissimilar materials are compatible with the substrates in the application.

Needed Materials

- #10 pan-head or washer-head, corrosion-resistant fastener. Minimum embedment of 1 1/4" into the structural framing (or as required by local code).
- 4", 6" or 9" wide self-adhered flashing: We recommend OSI® Butyl Flash Tape or equivalent.
- Sealant: We recommend OSI® QUAD® Max Sealant or equivalent (for interior air seal). This sealant can be used in any application and can be painted or ordered in a color-matched product if desired.

- Polyurethane low expansion Window and Door foam: We recommend OSI® QUAD® Foam or equivalent (for interior air seal).
- Backer rod: 1/8" larger than the widest portion of the gap (used in conjunction with sealant bead for interior air seal).
- Non-compressible or non-water degradable shims.

Potential Needed Tools

- Utility knife/shears
- J-roller
- Hammer
- Tape measure
- Caulking gun
- Level (4' minimum recommended)
- Drill with tapered bit and 3/8" countersink
- Pry bar

1

INSPECT PRODUCT

Remove Packaging

- Remove shipping materials such as corner covers, shipping blocks, shrink wrap or pads. If there is a protective film on the glass, **DO NOT** remove it until installation and construction are complete.
- **DO NOT** remove the installation label until after the inspection of the job is complete.

Inspect Window

- Cosmetic damage.
- Product squareness (diagonal measurements not more than 1/4" different).
- Correct product (size, color, grid pattern, handing, glazing, energy-efficiency requirements, etc.).
- Cracked frame welds or other frame damage.
- Splits, cracks, holes, missing sections or other damage to the nailing fin longer than 6" and/or within 1/2" of the window frame.

If any of the above conditions represent a concern, or if you expect environmental conditions to exceed the window's performance rating, **DO NOT** install the window. Contact your dealer or distributor for recommendations.

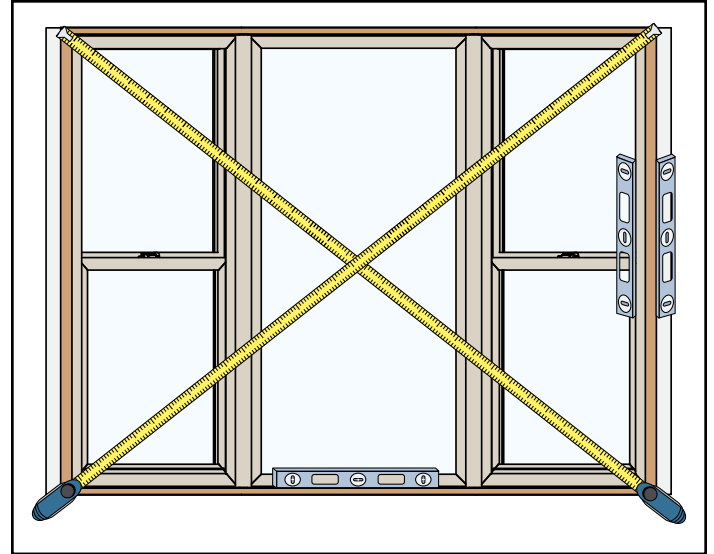

2 INSPECT ROUGH OPENING (R.O.)

CAUTION

The use of a sill pan and other barriers will decrease the rough opening height clearance. Adjust the opening dimensions accordingly.

- Verify the width and height of the rough opening is 1/2" - 5/8" larger than the window width and height.
- Verify the rough opening is square. The (A) and (B) measurements should be the same. Suggested deviation from square is no more than 1/4".
- Verify the rough opening is level and plumb (C, D and E). Suggested deviation from square is no more than 1/8".
- The rough opening sill should not be crowned or sagged (D), but rather level or sloped (positive slope) to the exterior.
- The exterior face of the rough opening should be in a single plane (E) with less than 1/8" twist from corner to corner.
- Minimum double studs (king and jack/trimmer) should be used to support the header at all rough openings.

Verify Square, Level and Plumb

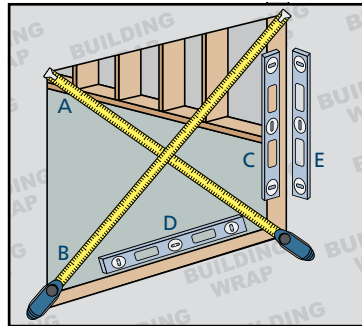

For Retrofit Installations

Verify the rough opening framing is structurally sound. Contact your local waste management entities for proper disposal or recycling of products being removed.

This installation guide only addresses sheathed wall, open-stud construction and exterior foam insulation. For exterior foam insulation construction, please reference FMA/AAMA/WDMA 500 for additional install and framing details. If installing into an opening other than what is identified, consult a building professional.

Fully Sheathed Wall Construction

Sheathing is applied to the exterior of the wall framing. The window will be mounted flush against the sheathing or building wrap in a weatherproof manner.

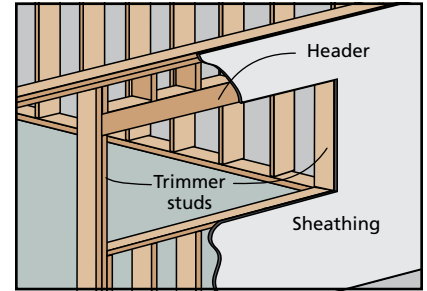

Open-Stud Construction

Sheathing is absent and building wrap is applied atop of the wall framing. The window will be mounted flush against building wrap and/or framing members (studs).

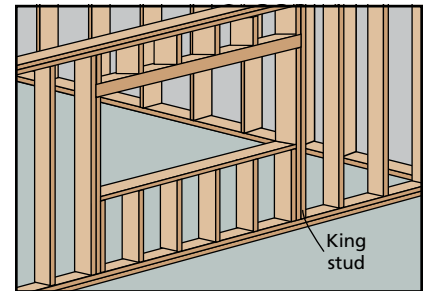

Exterior Foam Insulation Construction

Exterior Foam insulation is applied to the exterior of the wall framing. The window will be mounted to a structural support member on the same plane as the exterior foam insulation in a weatherproof manner (refer to FMA/AAMA/WDMA 500 for additional install and framing details).

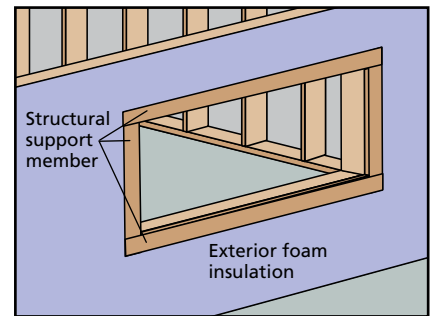

3 INSTALL SILL PAN

Prepare Sill

1. Install a sill pan in a weatherproof manner on the rough sill (refer to **ASTM 2112** for types of sill pans). Always allow water to drain out of the pan and onto the building wrap, drainage plane or to the exterior.
NOTE: For a Bay and Bow window, self-adhered flashing is recommended to create the sill pan (rather than a ridged sill pan).

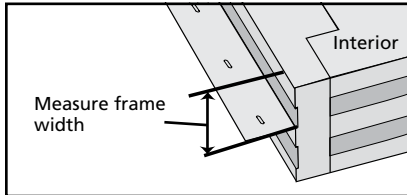

2. If using self-adhered flashing to create the sill pan, measure the width of the frame from the interior to nailing fin and subtract 1/4". Transfer this measurement from the outside edge of the rough opening sill and draw a line all along the rough opening sill. The line will address where the back of the flashing will sit.

Shim the Sill

1. Place the shims in the sill pan as needed to level the window and prevent sagging or bowing. See **Product Installation Tolerance Table** for tolerances. Shims should be aligned as defined by the label on the window or as stated below:

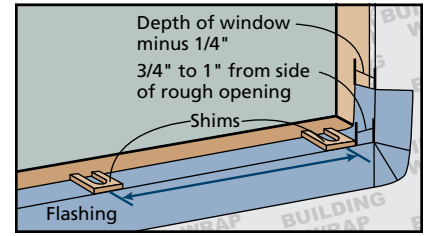

- Shims (1/4" maximum) should be placed near the exterior edge of the sill pan.
- Place one shim 3/4" to 1" from each side of the rough opening (if the rough opening is sized correctly, this should be approximately 1/2" from the corner of the window).
- Shim in a manner that evenly supports the window.
- For mullied units, ensure there is a shim located 1/2" on each side of the mull joint (see comments below).
- There should always be a drainage path to the exterior out of the sill pan.
- Shims can be held in place with sealant.
- Increased shim height may be needed or may interfere with bar/grill alignment of adjacent windows/doors.

4 TEMPORARILY FASTEN AND SHIM PRODUCT

⚠ WARNING

To avoid injury, use at least two people to install. Adequately support the window until completely fastened.

1. Fastener locations around the interior perimeter should be pre-drilled and countersunk prior to setting the window into the opening.
 - Pilot holes should be located 1 1/2" from the interior edge.
 - Holes should be located 4" from each corner and then 12" on-center and applied on all four sides of the window frame.
 - Countersink each pre-drilled hole to accept a #10 pan head fastener.

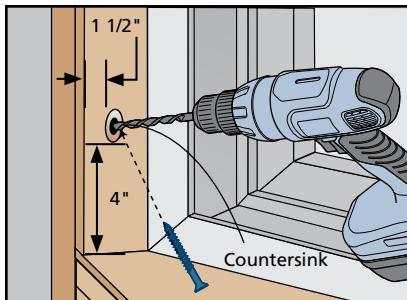

2. Run a continuous bead of sealant along the interior surface of both nail fins.
3. Place the window onto the shims and tilt into the rough opening. The shims must fully and evenly support the sill of the window. Adjust the shims as needed.

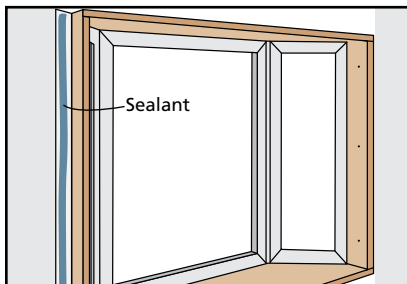

4. From the exterior, temporarily fasten the window by placing a fastener 3" - 6" from one of the upper corners of the nail fin. Make sure to fully support the window.
5. From the interior, shim within 4" - 6" from each corner on both sides of the window frame. Apply additional shims to the sides and head as necessary to ensure the window position within the opening is plumb, level, square and without twist.
NOTE: Shims can be secured with sealant. All shims must be set back from the interior of the window frame a minimum of 1/4".

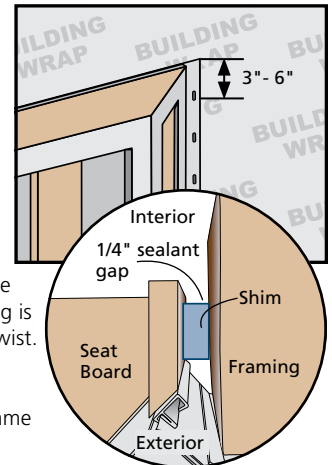

6. Fasten the jambs, head and seat board through the pre-drilled and countersunk pilot holes using #10 pan head fasteners. A shim should be located near each fastener to prevent frame deflection.
NOTE: Shims should be cut back 1/4" - 1/2" from the interior face of the main window frame.

5 FASTEN PRODUCT (SIZE AND SPACING)

Common Window Fastening

Areas such as Florida and the Texas TDI region have different anchoring requirements based on product certification. For information on specific products, visit www.floridabuilding.org or www.tdi.texas.gov and follow the anchoring schedule given in the drawings for the product instead of the anchoring schedule in this document.

1. From the exterior, continue to place the fasteners through the nailing fin.
2. Fasteners should be placed 3" – 6" from each end of the nailing fin and no more than 8" on-center.

Product Installation Tolerance Table	
Products must be installed in a manner that Does Not exceed the tolerance below.	
Plumb	+/- 1/8"
Level	+/- 1/8"
Twist	+/- 1/8"
Square	+/- 1/8" product sized up to 20 sq. ft. +/- 1/4" product sized over 20 sq. ft.

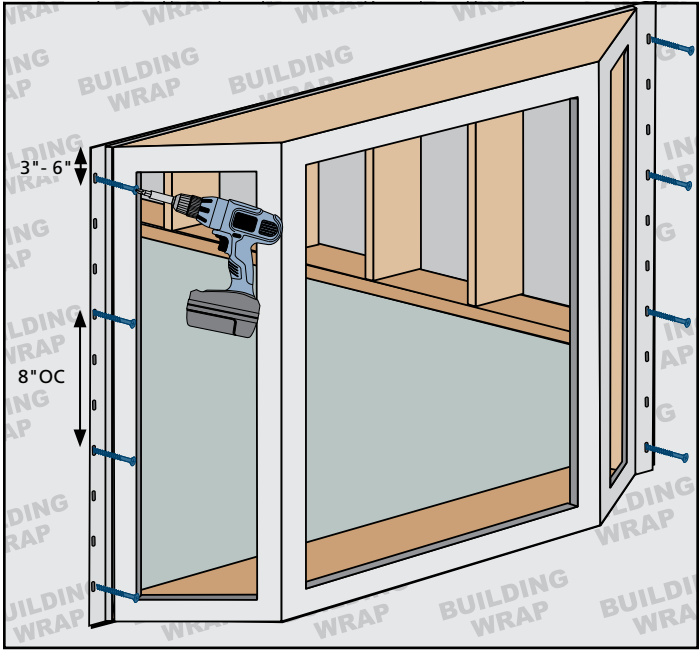

6 INSTALL DRIP CAP

The use of a drip cap on all window/door products is recommended, regardless if supplied. A drip cap is **required** on any *vertical* mullid/joined products, regardless if supplied. **NOTE:** A drip cap may not be suitable for some product lines (e.g. brickmould vinyl, flush fin, vinyl flat casing), regardless these product lines need to be incorporated into the wall in a weather-shedding manner.

Bracing Installation

1. If the window has a pre-installed cable support system, follow the instructions provided by the manufacturer.
2. If the cable support system is not used, build a seat board bracing to support at least 750 lbs of total weight (window plus window contents). Primary support should be provided under the mull joints of the unit.
3. Remove any temporary support after the full bracing has been installed.

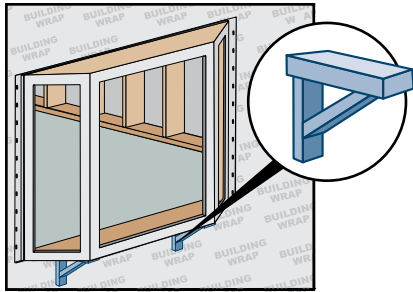

7 CREATE "INTERIOR" AIR SEAL

Continuous Air Seal

NOTE: Shims may need to be cut back, so the interior air seal is "continuous" between the window frame and the rough opening.

Create a continuous air seal on the interior by integrating the rough opening and the window frame with low expansion polyurethane foam or backer rod and sealant. If needed, apply additional sealant between the sill pan or rough sill and the window frame.

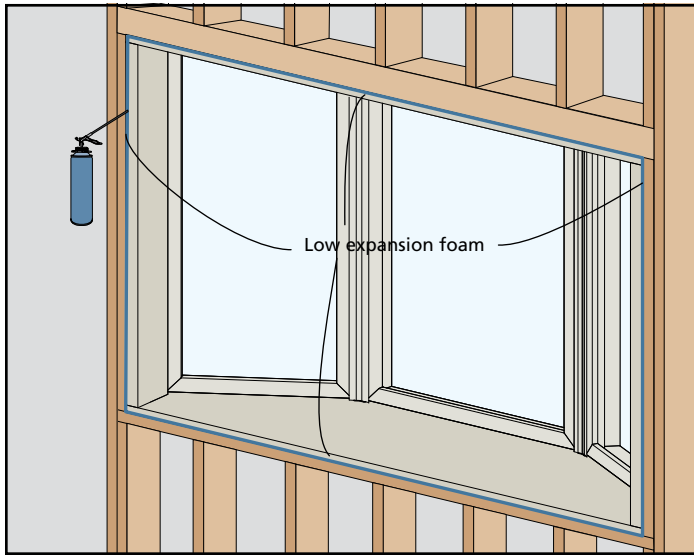

After Installation

- **Ensure weep holes/channels are clear of debris for proper water drainage. DO NOT seal weep holes/channels.**
- Install exterior wall surface per manufacturer's guidelines.
- Leave an expansion/contraction gap of approximately 3/8" between the window frame and final exterior wall surface (siding, stucco, etc.). For a finished look and additional protection, seal this gap on the sides with backer rod and sealant. If sealant is applied above the drip cap, ensure the sealant bead is discontinuous to allow for drainage.
- Remove protective film (if applicable) on the glass within six months.
- Protect recently installed units from damage from plaster, paint, etc.
- The head and seat board should be protected (e.g. roof, skirt) and insulated with rigid foam.

Please visit jeld-wen.com for warranty and care and maintenance information.

Thank you for choosing
JELD-WEN