

Features

- Double (medium/large) bowl.
- Smart Divide® lowered divider.
- With 6-11/16" (170 mm) Self-Trimming integral apron.
- Fits a standard 36" sink base cabinet.
- 35-1/2" (902 mm) x 21-9/16" (548 mm)

Material

- KOHLER® enameled cast iron.
- Acid-resistant enamel finish.

Installation

- Under-mount

Recommended Accessories

- K-9000 P-Trap
- K-5828 Sink Rack
- K-5874 Sink Rack
- K-6377 Sponge Caddy
- K-6378 Kitchen Brush Caddy
- K-6379 Kitchen Squeegee
- K-6382 Disinfecting Wipes Dispenser
- K-6383 Soap Dispenser
- K-8618 Paper Towel Holder
- K-8619 Flexible Kitchen Mat
- K-8624 Dish Scraper

Optional Accessories

- K-8801 Sink Strainer

Components

Additional included component/s: Countertop cut-out template, and Cabinet face cut-out template.



Codes/Standards















ASME A112.19.1/CSA B45.2

KOHLER® Enameled Cast Iron Kitchen Sink Lifetime Limited Warranty

See website for detailed warranty information.

Available Color/Finishes

Color tiles intended for reference only.

Color	Code	Description
	0	White
	FF	Sea Salt™
	96	Biscuit
	47	Almond
	FD	Cane Sugar™
	NY	Dune
	95	Ice™ Grey
	G9	Sandbar
	K4	Cashmere
	FT	Basalt
	58	Thunder™ Grey
	KA	Black 'n Tan
	FP	Caviar
	7	Black Black™

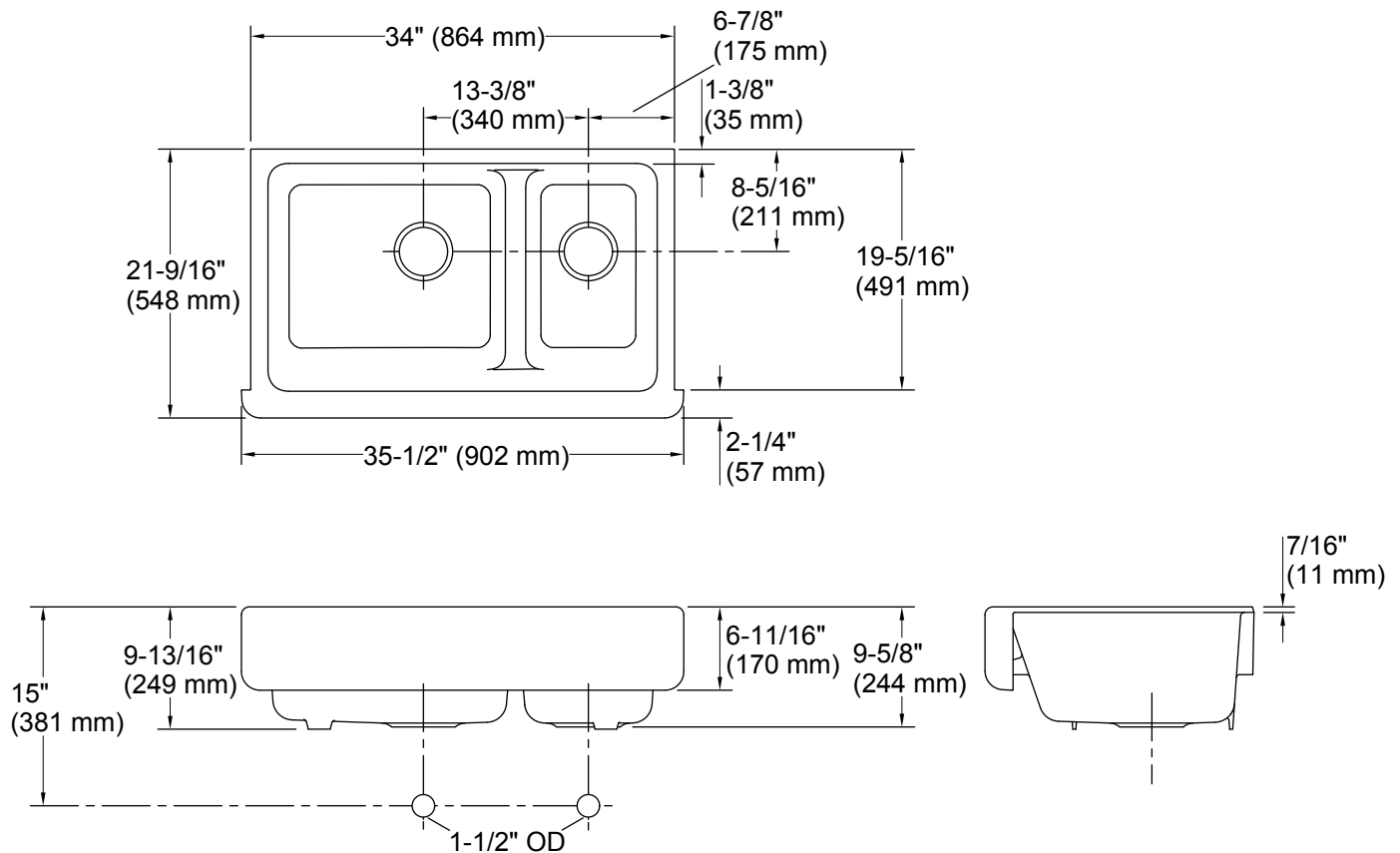

Technical Information

All product dimensions are nominal.

Bowl configuration:	Off-set Large/small
Installation:	Under-mount
Min. base cabinet width:	36" (914 mm)
Bowl area:	Length: 18-13/16" (478 mm) Width: 18-1/16" (459 mm) Bowl depth: 9" (229 mm) Water depth: 9" (229 mm)
Bowl area:	Length: 10-5/16" (262 mm) Width: 18-1/16" (459 mm) Bowl depth: 9" (229 mm) Water depth: 9" (229 mm)
Drain hole:	3-5/8" (92 mm)

Notes

Install this product according to the installation instructions.

NOTICE: The countertop manufacturer or cutter must use the cut-out template provided with the product, or a current one provided by Kohler Co. (call 1-800-4KOHLER). Kohler Co. is not responsible for cut-out errors when the incorrect cut-out template is used.

IMPORTANT! The distance from the top edge of the cabinet to the top of the cabinet door must be at least 6-7/8" (175 mm) to install this sink.