



ECCOTEMP iE SERIES ELECTRIC TANKLESS
WATER HEATER
USE & CARE MANUAL
WITH INSTALLATION INSTRUCTIONS FOR THE INSTALLER



MODELS: iE-11 iE-18 iE-24 iE-27

FULLY DIGITAL & TOUCHSCREEN DISPLAY - CHILD LOCK FEATURE
SMART TECHNOLOGY TEMP CONTROL - REVOLUTIONARY HEATING ELEMENT DESIGN
ETL APPROVED - ENERGY EFFICIENT

iE
Series



ECCOTEMP
THE FUTURE OF EFFICIENCY

ECCOTEMP.COM

SCAN ME
for more product info





ECCOTEMP

THE FUTURE OF EFFICIENCY

PLEASE NOTE: THIS MANUAL IS SUBJECT TO CHANGE AT ANY TIME. TO ENSURE THIS MANUAL IS UP TO DATE PLEASE VISIT OUR HELP DESK AT WWW.ECCOTEMP.COM FOR ALL OF OUR PRODUCT MANUALS.





Product Support: Eccotemp.com/help-desk









Shop Online: Eccotemp.com/products





Store Locator: Eccotemp.com/locator

		Eccotemp Systems, LLC 315-A Industrial Road Summerville, SC 29483 866-356-1992	
TANKLESS ELECTRIC WATER HEATER			
		MODEL #: iE-11	
RATING:	240Vac, 60Hz, 11000W		
FLOW RATE:	0.85-3.2 GPM		
REQUIRED RATING OF CIRCUIT BREAKER: 60A			
CONFORMS TO UL STD. 499 CERTIFIED TO CSA STD. C22.2 NO.64-10			
CAUTION & ATTENTION: FOR HOUSEHOLD AND INDOOR USE ONLY			
POUR LES MENAGES ETL' UTILISTATION A L'INTERIEUR SEULEMENT.			
MADE IN CHINA			

		Eccotemp Systems, LLC 315-A Industrial Road Summerville, SC 29483 866-356-1992	
TANKLESS ELECTRIC WATER HEATER			
		MODEL #: iE-18	
RATING:	240Vac, 60Hz, 18000W		
FLOW RATE:	0.85-4.2 GPM		
REQUIRED RATING OF CIRCUIT BREAKER: 2x50A			
CONFORMS TO UL STD. 499 CERTIFIED TO CSA STD. C22.2 NO.64-10			
CAUTION & ATTENTION: FOR HOUSEHOLD AND INDOOR USE ONLY			
POUR LES MENAGES ETL' UTILISTATION A L'INTERIEUR SEULEMENT.			
MADE IN CHINA			

		Eccotemp Systems, LLC 315-A Industrial Road Summerville, SC 29483 866-356-1992	
TANKLESS ELECTRIC WATER HEATER			
		MODEL #: iE-24	
RATING:	240Vac, 60Hz, 24000W		
FLOW RATE:	0.85-6 GPM		
REQUIRED RATING OF CIRCUIT BREAKER: 3x40A			
CONFORMS TO UL STD. 499 CERTIFIED TO CSA STD. C22.2 NO.64-10			
CAUTION & ATTENTION: FOR HOUSEHOLD AND INDOOR USE ONLY			
POUR LES MENAGES ETL' UTILISTATION A L'INTERIEUR SEULEMENT.			
MADE IN CHINA			

		Eccotemp Systems, LLC 315-A Industrial Road Summerville, SC 29483 866-356-1992	
TANKLESS ELECTRIC WATER HEATER			
		MODEL #: iE-27	
RATING:	240Vac, 60Hz, 27000W		
FLOW RATE:	0.85-6 GPM		
REQUIRED RATING OF CIRCUIT BREAKER: 3x50A			
CONFORMS TO UL STD. 499 CERTIFIED TO CSA STD. C22.2 NO.64-10			
CAUTION & ATTENTION: FOR HOUSEHOLD AND INDOOR USE ONLY			
POUR LES MENAGES ETL' UTILISTATION A L'INTERIEUR SEULEMENT.			
MADE IN CHINA			

PLEASE NOTE: THIS MANUAL IS SUBJECT TO CHANGE AT ANY TIME. TO ENSURE THIS MANUAL IS UP TO DATE PLEASE VISIT OUR HELP DESK AT WWW.ECCOTEMP.COM FOR ALL OF OUR PRODUCT MANUALS.



WARNING

If your water heater requires a reset, be sure to **TURN OFF THE BREAKERS** prior to resetting the unit.

Resetting your unit without turning off the breakers can result in personal injury and damage to your water heater.

WARNING! There is water contained in the coils of your water heater at all times. If your water heater is exposed to freezing temperatures, the water in the coils could freeze, causing a break in the heat exchanger of the unit, or the supply and return lines. This kind of damage will result in water running freely into the space where the water heater is located, which can cause flooding. **DO NOT** install this water heater where it may be subjected to a freeze. If your water heater is in an area where freezing is a possibility, you must turn off the water to the heater and drain it of any water by disconnecting the water lines. Leave the water lines disconnected until you intend to use the water heater.

Quick Start Guide

iE-18 | iE-24 | iE-27

1) Mounting

Mount vertically on a flat surface (i.e. board or wall) larger than the unit itself. Make sure bracket is secure by utilizing a stud or the provided wall anchors. Keep away from any potential splashing or leaking water and strong magnetic fields.

2) Water connections

When installing your water connections make sure to use 3/4" NPT fittings. Please use the provided gaskets to prevent leaks. When tightening fittings use a back-up wrench on inlet and outlet fittings (flat sides of fittings are located behind front cover). It is recommended to install a high pressure discharge valve and a shut off valve on the incoming water line, in that order. Open a faucet and run water through the unit for a few minutes to purge out air, turn off at faucet to build up pressure in the line to check for leaks.

3) Electrical connections

Wiring for electrical connection will differ depending on model please double check the model type on the right side of the unit.

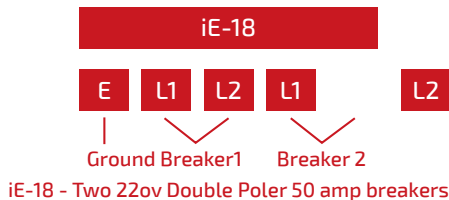

iE-18 - Two 220v Double Pole 50 amp breakers

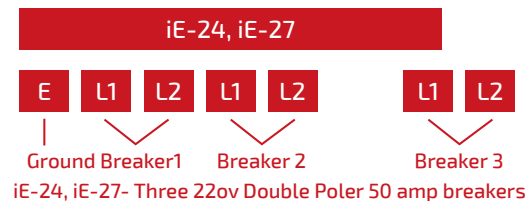

iE-24, iE-27- Three 220v Double Pole 50 amp breakers

4) Operation

Unit is activated by the flow of water through the inlet. A desired temperature set point is selected by using the "up" or "down" buttons, if unit does not respond push the center "power" button and try again. Test water to prevent scalding.

PLEASE NOTE: THIS MANUAL IS SUBJECT TO CHANGE AT ANY TIME. TO ENSURE THIS MANUAL IS UP TO DATE PLEASE VISIT OUR HELP DESK AT WWW.ECCOTEMP.COM FOR ALL OF OUR PRODUCT MANUALS.



WARNINGS

This is not a do-it-yourself project. Failure to have this appliance installed by a licensed plumber and electrician will void all warranties.

Under no circumstances should you attempt to install, repair or disassemble the Eccotemp tankless electric water heater without first shutting off all power to the unit directly at the circuit breaker box.

Installation of this product is restricted to indoor locations only by licensed plumbing or electrical contractors.

CONTENTS

Important Safety Instructions	1
Product Features & Recommended Uses	2
Electrical Diagrams	2-3
Technical Specifications	4
Product Structure	4-6
Installation Guidelines	6-10
Care and Maintenance	12

IMPORTANT SAFETY INSTRUCTIONS

- 1. The installation must be compliant with the National Electrical Code and your local electrical and plumbing codes.**
- 2. This appliance must be GROUNDED.**
- All wiring and installation must be performed by a qualified electrician.
- 4. CAUTION: This product has more than one power-supply connection point. Disconnect all power supplies before servicing.**
- This appliance is not intended for use by persons (including children) with reduced physical sensory or mental capabilities, or lack of experience and knowledge, unless they have been given supervision or instruction concerning use of the appliance by a person responsible for their safety. Children should be supervised to ensure that they do not play with the water heater.
- This water heater **MUST** be permanently connected to a fixed circuit breaker and **MUST** be installed vertically per the mounting instructions. **DO NOT** install this water heater near volatile or flammable substances, tinder wood or a strong magnetic field.
- 7. DO NOT** switch the heater on if you suspect that it may be frozen. This could result in serious damage to the unit. Wait until you are sure that it has completely thawed out before switching the heater back on.
- Before using the hot water, please feel the outlet hot water temperature with your hand to ensure it is suitable for showering to avoid getting scalded.
- Before connecting pipes to the water heater hoses, it is extremely important to FLUSH the pipes to wash away all plumbing paste or residue in the pipes.
- The heating chamber is treated with composite nano insulation material; it is natural if there might be a bit of smell or green blue smoke when the water heater is used for the first time.
- If there is damage to the wiring or any internal part, you must contact a qualified electrician to replace it. For warranty coverage or replacement parts please contact our customer service department at 1-866-356-1992 to file a claim or place an order. You may also visit www.eccotemp.com for more information.
- 12. CAUTION: FOR HOUSEHOLD AND INDOOR USE ONLY**
- 13. CAUTION: Risk of electric shock, CONNECT ONLY TO A CIRCUIT THAT IS PROTECTED BY A GROUND.**
- 14. SAVE THESE INSTRUCTIONS.**

PRODUCT FEATURES

The Eccotemp iE Electric tankless water heaters include patented technology with multi-safety devices, including the following features:

1. Tankless, instantaneous heating for on demand hot water, No pre-heating. No stand-by heating loss. Energy-saving.
2. Micro-computer control, adopting patented heating technology. Water is completely separated from electricity by multi-layers of composite nano insulation material.
3. Over-heating thermal cut-off to avoid scalds. Once outlet water temperature reaches 153°F/ 67°C, the electricity is automatically cut off. If this occurs, the screen will beep and display an E1 error code.
4. Malfunction sensor: If there is a malfunction with the temperature sensor, the heater will stop working and display an E3 error code.
5. Dry-heating thermal cut-off. In case of dry heating, the unit's electricity will be cut off and it will display an E4 error code.
6. Eccotemp Product Advantage: Eccotemp iE heating elements are made from a single piece of cast aluminum; so there will never be water leakage, non electric leakage in the heating chamber.

RECOMMENDED USES

iE-11 - Rated at 1.8 GPM @ 40°F temperature rise

1 to 2 single applications such as single shower, sink, washer, dishwasher located in warmer climates averaging incoming water temperatures above 65°F.

Not recommended: multiple applications; colder climates averaging water temperatures 50°F or lower.

iE-18 - Rated at 2.5 GPM @ 40°F temperature rise

1 to 2 single applications such as single shower, sink, washer, dishwasher

Not recommended: cold climates averaging water temperatures 50°F or lower; not intended for use on more than 2 applications at once.

iE-24 - Rated at 3 GPM @ 40°F temperature rise

Small cabin, apartment, office, or any other small dwelling with 2 applications or less.

Not Recommended: whole home installation or multi family dwelling; not intended for use on more than 2 applications at once.

iE-27 - Rated at 3.5 GPM @ 40°F temperature rise.

Medium to small 3 bedroom, 2 bath homes (ideally under 2500 square feet); any other dwelling with 3 applications or less.

Not Recommended: large homes or any other large dwelling; not intended for use on more than 3 applications at once.



ELECTRICAL DIAGRAM

MODEL IE-11

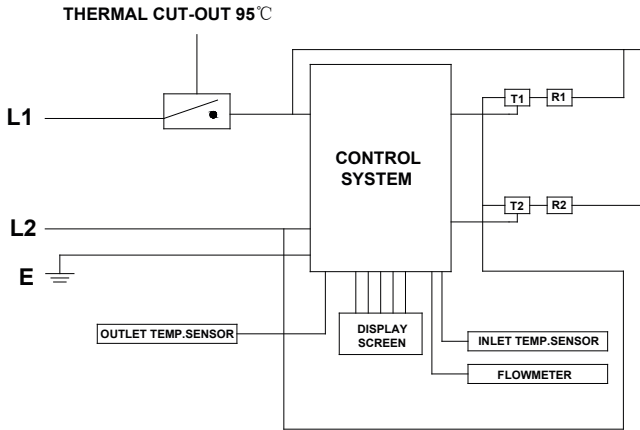

REMARK: J:RELAY R:HEATING SYSTEM T:TRIAC

MODEL IE-18

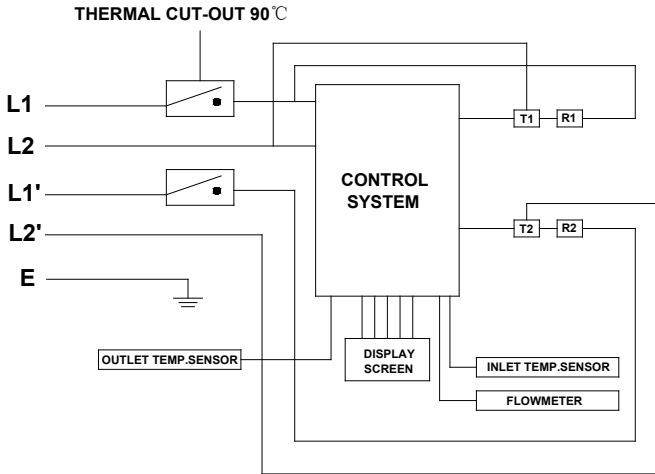

REMARK: J:RELAY R:HEATING SYSTEM T:TRIAC

PLEASE NOTE: THIS MANUAL IS SUBJECT TO CHANGE AT ANY TIME. TO ENSURE THIS MANUAL IS UP TO DATE PLEASE VISIT OUR HELP DESK AT WWW.ECCOTEMP.COM FOR ALL OF OUR PRODUCT MANUALS.



ELECTRICAL DIAGRAM CONTINUES... MODEL iE-24 and iE-27

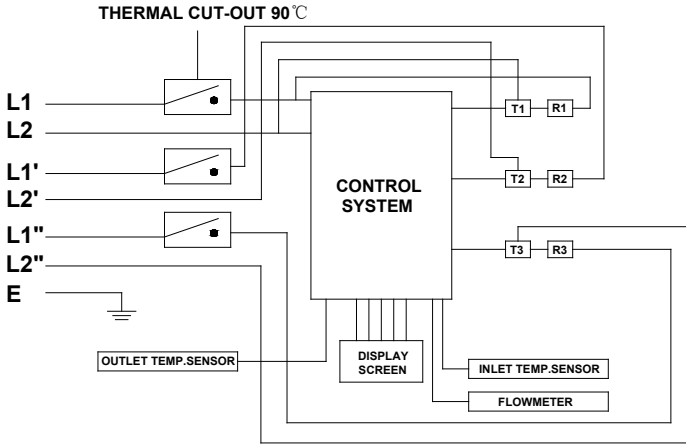

REMARK: J:RELAY R:HEATING SYSTEM T:TRIAC

TECHNICAL DATA

Model	iE-11	iE-18	iE-24	iE-27
Phase	1	1	1	1
Voltage V	240	240	240	240
Wattage kW	11	18	24	27
Max. Amp. Load A	50	75	100	113
Min. Required Circuit Breaker A	60	2x50	3 X 40	3 X 50
Min. Wire Size AWG Cooper	8	2 X 8	3 X 8	3 X 8
Min. Water Flow To Activate GPM / L/min.	0.53 / 2	0.85 / 3.2	0.85 / 3.2	0.85 / 3.2
Weight lbs.	7	11	12	12
Product Dimensions Inches	17.3x10.9x3.5			
Water Connections NPT	3/4"	3/4"	3/4"	3/4"

Note: *suitable recognized strain relief means shall be provided when the product installed.



PRODUCT INNER STRUCTURE

MODEL IE-11

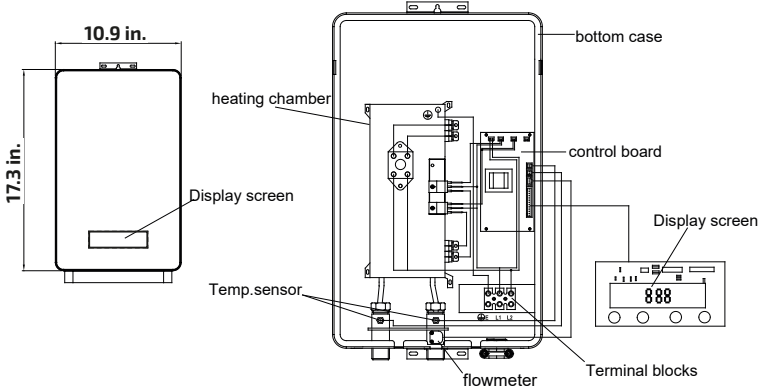

MODEL IE-18

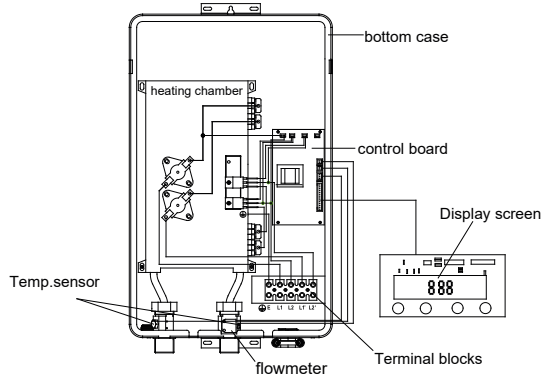

PLEASE NOTE: THIS MANUAL IS SUBJECT TO CHANGE AT ANY TIME. TO ENSURE THIS MANUAL IS UP TO DATE PLEASE VISIT OUR HELP DESK AT WWW.ECCOTEMP.COM FOR ALL OF OUR PRODUCT MANUALS.



PRODUCT INNER STRUCTURE CONTINUES...

MODEL IE-24 and IE-27

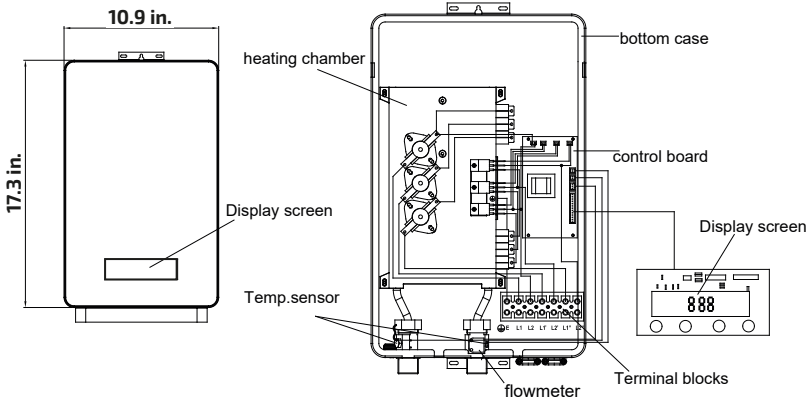

INSTALLATION GUIDELINES

Note: The installation must be compliant with the National Electrical Code and your local electrical and plumbing codes.

1. DO NOT install water heater near tinder, volatile or flammable substances, or near a strong magnetic field. The water heater must only be mounted in a VERTICAL position near the water fittings.
 2. Do not install the water heater in a room where there is a chance of freezing.
 3. Mount the water heater to a flat section of wall, well away from any potential water splashes or spray. Be sure to use wall anchors, or screw directly into studs.
 4. Position the water heater upright with all plumbing connections at the bottom of the unit.
-
1. Make sure the water heater is intact, and all fittings are complete.
 2. Please make sure the main power supply, water pressure, grounding condition, amp meter and wire meet all standards of installation requirements.
 3. The water heater must be connected to a properly-grounded, dedicated branch circuit with the proper voltage rating. The ground must be connected to the "ground bar" at the circuit breaker panel.
 4. This water heater **MUST** be permanently connected to fixed and dedicated circuit breakers. If the heater will be unused, switch off the circuit breakers.
 5. When installing new water heater please connect water fittings and turn water on so water flows through unit before turning **POWER ON**

PLEASE NOTE: THIS MANUAL IS SUBJECT TO CHANGE AT ANY TIME. TO ENSURE THIS MANUAL IS UP TO DATE PLEASE VISIT OUR HELP DESK AT WWW.ECCOTEMP.COM FOR ALL OF OUR PRODUCT MANUALS.



INSTALLATION LOCATION & METHOD

Fixed installation on the wall

Locate an appropriate place on a section of wall that meets all safety and installation requirements

1) Front and back of the water heater

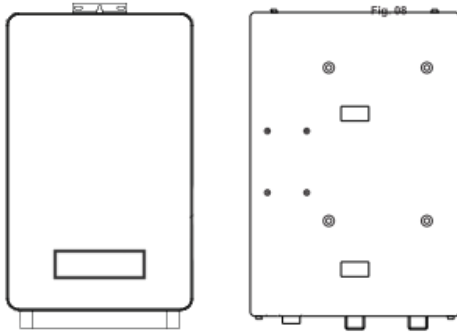

Fig. 1

2) Remove (4) screws and washers from the unit to free the front cover. Carefully lift the front cover off the unit a few inches. Disengage the ribbon cable connecting the front cover LCD panel to the main control board of the unit. Remove cover completely.

Please note: If LCD connection cable cannot be disengaged, simply set the front cover aside and keep the cable connected.

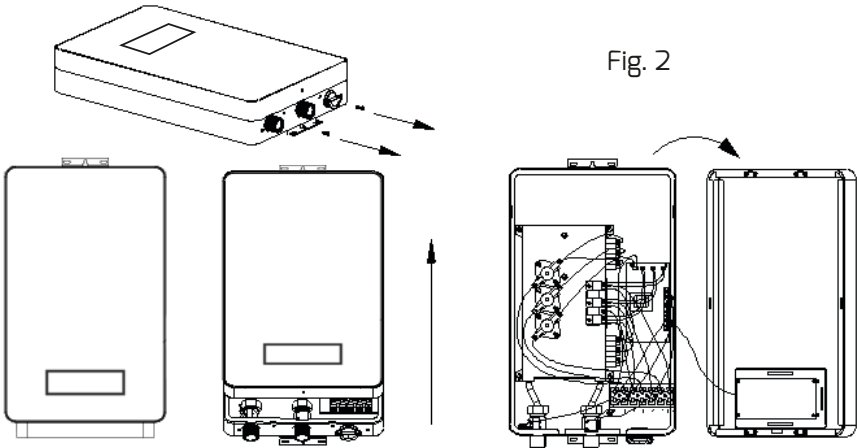

Fig. 2

PLEASE NOTE: THIS MANUAL IS SUBJECT TO CHANGE AT ANY TIME. TO ENSURE THIS MANUAL IS UP TO DATE PLEASE VISIT OUR HELP DESK AT WWW.ECCOTEMP.COM FOR ALL OF OUR PRODUCT MANUALS.



INSTALLATION LOCATION & METHOD CONTINUED...

- 3)** To attach the water heater to the wall start by holding the water heater on the wall in it's desired location. Make sure that the water heater is level and mark the wall where the mounting holes should be located. Drill holes of 1/4" diameter in the marked locations. Please Note: If you are on a stud, screw the bracket directly into the wall. If you are not on a stud, insert the plastic anchor in the hole and secure the brackets using the screws supplied. Affix 2 screws in the center holes and attach the water heater by sliding on the screws. Finish securing the water heater to the wall by using the 4 additional screws into the other previously drilled holes.

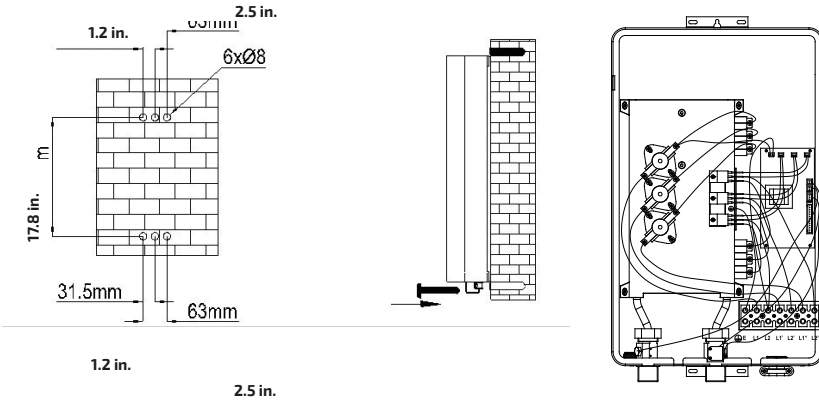

- 4)** Connect the cable to the terminal blocks, please notice the guidance logo below the terminal blocks. iE 11 will be connected to one circuit breaker. iE18 will be connected to two circuit breakers. iE24 and iE27 will be connected to three circuit breakers.

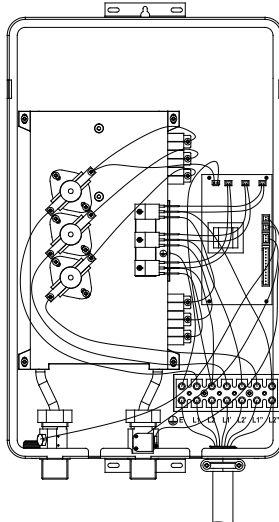

PLEASE NOTE: THIS MANUAL IS SUBJECT TO CHANGE AT ANY TIME. TO ENSURE THIS MANUAL IS UP TO DATE PLEASE VISIT OUR HELP DESK AT WWW.ECCOTEMP.COM FOR ALL OF OUR PRODUCT MANUALS.



INSTALLATION LOCATION & METHOD CONTINUED...

- 5) Reattach the ribbon cable for the LCD panel if disconnected and reinstall the front cover using the screws and washers previously removed.

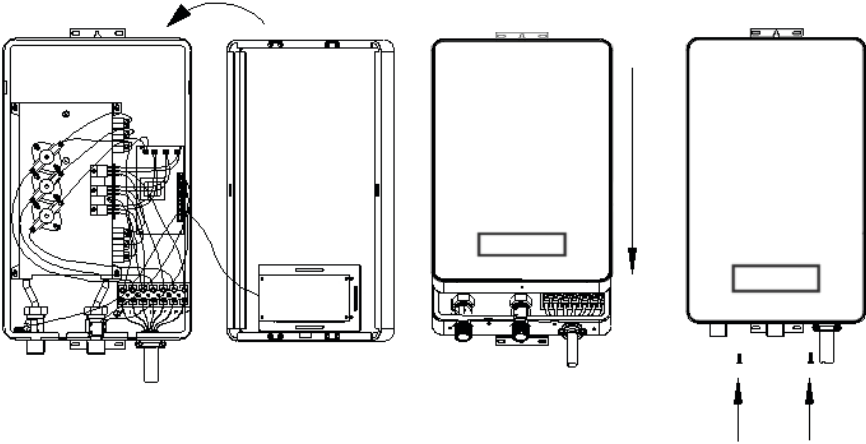

- 6) Connect the water pipe to the water inlet and water outlet connections, please remember to install the rubber seal ring. Please note: Use a backup wrench when installing water fittings.

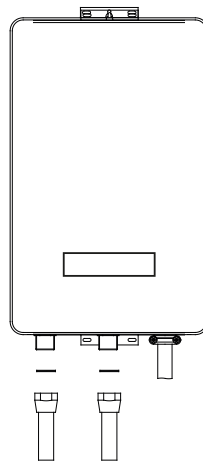

PLEASE NOTE: THIS MANUAL IS SUBJECT TO CHANGE AT ANY TIME. TO ENSURE THIS MANUAL IS UP TO DATE PLEASE VISIT OUR HELP DESK AT WWW.ECCOTEMP.COM FOR ALL OF OUR PRODUCT MANUALS.



INSTALLATION LOCATION & METHOD CONTINUED...

7) Connect the valve cover.

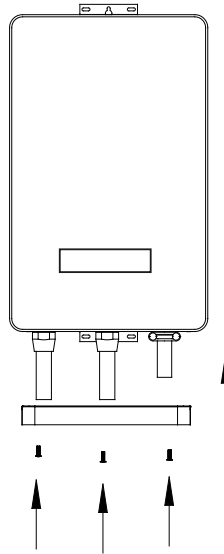

Water connections

1. All water pipe must comply with national and applicable state and local water pipe codes.
2. The unit should be connected directly to the main water supply. Flush pipe with water to remove any debris or loose particles
3. It is required that 3/4" NPT water connections be used with the following models, iE11, iE18, iE24, iE27.
4. Please remember to install rubber seal rings at the connections. When all water connections are completed, check for leaks and take corrective action before proceeding.
5. Connect the cold water supply to the threaded pipe labeled "Inlet" and the hot water to the threaded pipe labeled "Outlet". **IMPORTANT: RUBBER WASHER MUST BE USED FOR PROPER SEAL.**







Electrical connection

1. All electrical work must comply with national and applicable state and local electrical codes
2. All units must be connected to a properly grounded dedicated branch circuit of proper voltage rating.
3. Before beginning any work on the electric installation, be sure that main breaker panel switch is OFF to avoid any danger of electric shock, all mounting and plumbing must be completed before proceeding with electrical hook-up.
4. iE11 can be connected to a single circuit, use a supply cable protected by a double pole breaker. Connect the cold water supply to the threaded pipe labeled "inlet" and the hot water to the threaded pipe labeled "outlet". **IMPORTANT: RUBBER WASHER MUST BE USED FOR PROPER SEAL.**
5. iE18 require two independent circuits. Use two supply cables protected by two separate double pole breakers.
6. iE24, iE27 require three independent circuits. Use three supply cables protected by three separate double pole breakers.
7. While feeding the cable to terminal blocks, please make sure the metal wire ends and the terminal blocks touch completely. Then tighten the screws to make sure there is full contact and the current can go through.

PLEASE NOTE: THIS MANUAL IS SUBJECT TO CHANGE AT ANY TIME, TO ENSURE THIS MANUAL IS UP TO DATE PLEASE VISIT OUR HELP DESK AT WWW.ECCOTEMP.COM FOR ALL OF OUR PRODUCT MANUALS.



OPERATION INSTRUCTIONS

- Turn on the circuit breaker to bring electrical power to the unit.
- Open water faucet for a few minutes until water flow is continuous and all air is purged from water pipes. The unit must be operated after the breakers are turned on.
- After the unit is supplied with power, a beep sound can be heard and LED lights for 2 seconds, no other display, the appliance keeps standby.
- Touch  to turn ON/OFF the water heater. When the unit is ON, LED displays actual water temperature of the outlet. When the water heater is not operating, the screen will switch to the screen saver after 15 seconds. The display screen light will be off. Touch the screen, it will return to operating mode.
Touch  and  to adjust the outlet temperature. Temperature setting range is 86-127°F.
- If the unit has been paused, You may initially get a short burst of very hot water while you turn on again. Please run the water through for a few seconds to let the temperature settle down. Please check hot water with hand before using hot water.
 - If the unit will not be used in winter, drain out water completely so that the heater will not FREEZE.
 - Please periodically clean inlet strainer and the shower to keep a free water flow.
- Touch  and hold on for 5 seconds to lock the operation keys and the  will light in the display screen. All the operational keys can not function.
Touch  key and hold on for 5 seconds to lift the temperature lock and the  will disappear in the display screen. The operational keys can function right now.
- The real time water flow (GPM) displays in the screen when there is water flow through the water heater.
- There is a automatic memory function to avoid repetitive operation, while you turn on the appliance, the default set temperature will be the same as last time it was set.

TROUBLE-SHOOTING

Problems	Possible Causes	Corrective Actions
1. Inlet and outlet fittings leaking	A. Fittings are not tight B. Rubber washer worn-out	A. Tighten fittings. B. Change rubber washer.
2. No LED signal	A. Power not connected. B. LED damaged.	A. Connect power to the unit. B. Change LED.
3. Functional keys not working	A. No water out from shower. B. Water pressure too low. C. Key or PCB damaged.	A. Open valve to get water. B. Open valve to get pressure. C. Change key or PCB.
4. Water too hot	A. Too high temperature set. B. Water flow too little.	A. Set a lower temperature. B. Open valve more.
5. Water too cold	A. Low temperature set. B. Water flow too much.	A. Set a higher temperature. B. Reduce water flow.
6. Reduced outlet water pressure	Inlet strainer or shower clogged.	Clean strainer and shower.
7. LED displays E1	Outlet temperature is over 67°F/153°F	A. Reduce the temperature B. Turn up the water flow
8. LED displays E3	Temperature sensor failure	Please contact with your local dealer
9. Display overload	Inlet water flow is too high.	Reduce the inlet water flow

7 and 9 should only be performed by qualified electrician. The person who initially installed the unit is the best one to contact for help.

Error Code	Error Description	Possible Cause	What to Do
E1	Overheating Thermal Cut-off	The unit has reached a temperature of 153F/67C	Check the reset buttons on heating elements. Possible Triac failure. Contact Technical Support for help.
E3	Sensor Malfunction	The temperature sensor has stopped working	Outlet Temperature sensor failure. Contact Technical Support.
E4	Dry-heating thermal cut-off.	In case of dry heating, the unit's electricity will be cut off	Possible Flow Meter sensor failure. Contact Technical Support.
A03	Sensor Malfunction or Power Board Failure	Power Board failure	Possible Power Board Failure. Contact Technical Support.

PLEASE NOTE: THIS MANUAL IS SUBJECT TO CHANGE AT ANY TIME. TO ENSURE THIS MANUAL IS UP TO DATE PLEASE VISIT OUR HELP DESK AT WWW.ECCOTEMP.COM FOR ALL OF OUR PRODUCT MANUALS.



CARE AND MAINTENANCE

Note: Do not attempt to repair this water heater yourself. Call a qualified electrician or plumber for assistance. Before attempting any maintenance on the water heater, always make sure all power supplies are off and/or disconnected including circuit breakers. Some water heaters require more than one breaker so be sure that all circuit breakers are in the off position. In addition, you must turn off all water supply to the water heater before maintenance.

This unit does not require any regular maintenance. However, to ensure consistent water flow, it is recommended to follow the following procedures.

1. Periodically remove scale and dirt that may build up at the aerator of the faucet or in the shower head.
2. There is a built in filter screen at inlet connection which should be cleaned from time to time. Please turn off the water flow before doing this.

6 MONTH CLEANING ROUTINE

To prevent water scale, lime or rust deposit buildup and ensure your Eccotemp tankless water heater is running as efficiently as possible it is highly recommended that you clean your Eccotemp tankless water heater every 6 months. To do this we recommend that you use our Eccotemp EZ-Flush System Descaler Kit. For more information and to purchase please visit us at www.eccotemp.com or call 1-866-356-1992.



EXPLOSIVE VIEW

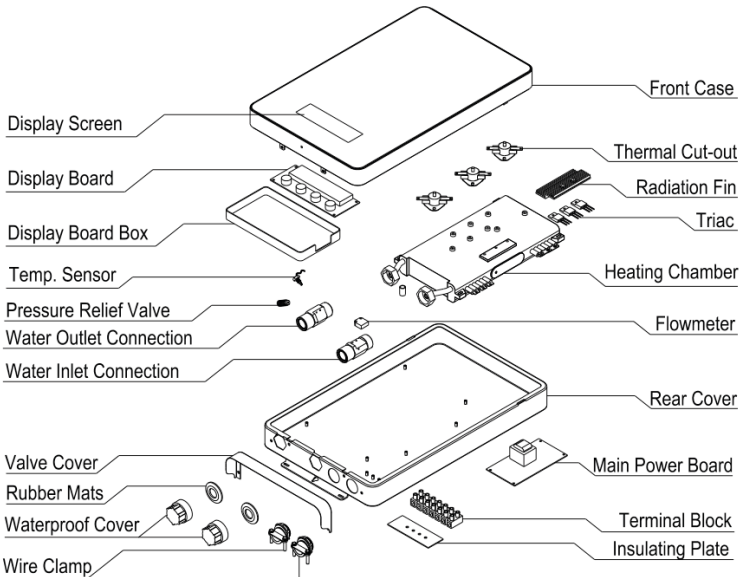

PLEASE NOTE: THIS MANUAL IS SUBJECT TO CHANGE AT ANY TIME. TO ENSURE THIS MANUAL IS UP TO DATE PLEASE VISIT OUR HELP DESK AT WWW.ECCOTEMP.COM FOR ALL OF OUR PRODUCT MANUALS.



Eccotemp Systems ,LLC Limited Warranty Information

MODELS: iE-11 E-18 iE-24 iE-27

Eccotemp hereby warrants this product to be free of material defects in materials and workmanship when installed and operated according to Eccotemp's installation and operating instructions. This Limited Warranty extends to the original purchaser and subsequent owners, but only while the product remains as the site of the original installation. This Limited Warranty terminates if moved or reinstalled at a new location. There are no warranties, express or implied made or given other than contained in this Limited Warranty. No agent, employee or representative of Eccotemp has any authority to bind Eccotemp to any representation or warranty concerning the Product not contained in this Limited Warranty. Eccotemp reserves the right and authority to change, modify or alter this warranty at any given time.

Except as expressly set forth herein, THERE ARE NO REPRESENTATIONS OR WARRANTIES, EXPRESS OR IMPLIED, INCLUDING, WITHOUT LIMITATION, AS TO MERCHANTABILITY OR FITNESS FOR A PARTICULAR PURPOSE WITH RESPECT TO ANY GOODS SOLD HEREUNDER. BUYER'S EXCLUSIVE REMEDY IS LIMITED TO REPAIR OR REPLACEMENT OF THE GOODS SOLD, AT ECCOTEMP'S DISCRETION. ECCOTEMP SHALL NOT BE LIABLE FOR INCIDENTAL OR CONSEQUENTIAL DAMAGES.

Limited Warranty Period

This Warranty is extended by Eccotemp Systems to the Owner. This warranty takes effect on the date of installation of the Product or 30 days after the date of purchase, whichever occurs first, and is effective until the specified anniversary of such date as follows:

Item Period of Coverage

Heating Chamber/Element 3 years
All other parts 2 years

Coverage's are void if the unit is used in a hot water circulation loop, in series with a circulation system or where an on-demand recirculation system is not incorporated.

Owner is responsible for all other costs incidental to repair such as labor, shipping, delivery and permits. Proof of purchase required. Products repaired will be covered under this Limited Warranty for the remainder of term of the original purchase.

Exclusions

Please refer to the Installation Manual and Use & Care Manual supplied with your new Eccotemp Systems product. This Limited Warranty becomes null and void if any of the following are determined to be a contributing factor by Eccotemp to the failure of the product:

1. Abuse, misuse, alteration, neglect or misapplication.
2. Improper, dangerous, destructive maintenance procedures or inadequate maintenance.
3. Damages caused by services performed by servicers other than Eccotemp Systems.
4. Installation in a corrosive or otherwise destructive environment.
5. Damage as a result of freezing within the unit or surrounding piping.
6. Scale buildup.
7. Incorrect voltage, amps or water pressure .
8. Acts of force Majeure.
9. Damage as a result of use with non-portable, untreated or poorly treated well water, or water with high PH levels or hardness levels in excess of 12 grains per gallon (200mg/L).
10. Incorrect sizing for the application.
11. Products with original serial numbers that have been removed or altered and cannot be readily determined.
12. Acts of God including, but not limited to; fire, flood, or nature disaster.

PLEASE NOTE: THIS MANUAL IS SUBJECT TO CHANGE AT ANY TIME. TO ENSURE THIS MANUAL IS UP TO DATE PLEASE VISIT OUR HELP DESK AT WWW.ECCOTEMP.COM FOR ALL OF OUR PRODUCT MANUALS.



This Product is not to be used as a pool or spa heater.

In the event of an Eccotemp Systems recognized defect, malfunction, or failure to conform to this Warranty and based upon Eccotemp approval of warranty claim, Eccotemp Systems, at its sole and absolute discretion, will settle the warrant claim of such defect, malfunction, or failure to conform to this Warranty. In order to make a claim under this Warranty, The Owner must notify Eccotemp of the failure of the Product to conform to this Warranty.

Under this Warranty, Eccotemp Systems will only provide replacement parts as described in the "Limited Warranty Period". The Owner will be responsible for any cost incurred including labor costs for servicing the unit, shipping, delivery, and handling of the replacement part, cost for permits or materials necessary for the repair, or incidental costs resulting from damage external to the unit resulting from the failure.

NOTWITHSTANDING ANYTHING IN THIS WARRANTY TO THE CONTRARY, EXCEPT FOR ECCOTEMP SYSTEMS' AFFIRMATIVE OBLIGATIONS EXPRESSLY SET FORTH IN THIS WARRANTY, ECCOTEMP SYSTEMS DISCLAIMS ANY AND ALL WARRANTIES, EITHER EXPRESS OR IMPLIED, REGARDING THE PRODUCT AND ITS FUNCTIONALITY, PERFORMANCE, MERCHANTABILITY, FITNESS FOR PARTICULAR PURPOSE OR INTELLECTUAL PROPERTY RIGHTS. ECCOTEMP SYSTEMS DISCLAIMS ALL OTHER OBLIGATIONS OR LIABILITIES ON ITS PART AND NEITHER ASSUMES NOR AUTHORIZES ANY OTHER PERSON TO ASSUME FOR ECCOTEMP SYSTEMS AN OTHER LIABILITIES IN CONNECTION WITH THE PERFORMANCE OF THE PRODUCT. THIS WARRANTY ONLY COVERS REPLACEMENT PARTS AND DOES NOT COVER COST OF LABOR OR SERVICES UNDER ANY CIRCUMSTANCES.

Systems by any other part for damages of any kind, including, but not limited to incidental and consequential damages, arising out of the subject matter of this Agreement. Some States do not allow exclusion or limitation of incidental or consequential damages, so the above limitation or exclusion may not apply to you. This warranty gives you specific legal rights. You may also have other rights that vary from State to State.

PLEASE NOTE: THIS MANUAL IS SUBJECT TO CHANGE AT ANY TIME, TO ENSURE THIS MANUAL IS UP TO DATE PLEASE VISIT OUR HELP DESK AT WWW.ECCOTEMP.COM FOR ALL OF OUR PRODUCT MANUALS.



CHECK OUT SOME OF OUR OTHER ECCOTEMP PRODUCTS

WHOLE HOME PRODUCT COMPARISONS

iE-11



iE-18



iE-27



SPECIFICATIONS

	iE-11	iE-18	iE-27
INSTALLATION	INDOOR ONLY	INDOOR ONLY	INDOOR ONLY
Rated GPM	1.8 Gallons per Minute	2.5 Gallons per Minute	3.5 Gallons per minute
Voltage	240	240	240
Kilowatt	15kw	18kw	27kw
Max Amp. Load	50	75	113
Min. Req. Circuit Breaker	60	2x50	3x50
Wire Size (AWG)	#8	#8	#8
Temperature Control	Automatic 86° - 140°F	Automatic 86° - 140°F	Automatic 86° - 140°F
Temp Rise	1 GPM - 52°F	1.25 GPM - 80°F	1.75 GPM - 80°F
Temp Rise	1.8 GPM - 35°F	2.5 GPM - 40°F	3.5 GPM - 40°F
Temp Rise	2.8 GPM - 17°F	3.75 GPM - 20°F	5.5 GPM - 20°F
Warranty	2 year limited	2 year limited	2 year limited
Product Dimensions	19.75"x10.75"x3.25" - 25 lbs	19.75"x10.75"x3.25" - 25 lbs	19.75"x10.75"x3.25" - 27 lbs
Suggested Uses	1 to 2 single use applications	apartment, cottages, whole home, 2 applications in warmer climates	whole home, multiple applications

PLEASE NOTE: THIS MANUAL IS SUBJECT TO CHANGE AT ANY TIME. TO ENSURE THIS MANUAL IS UP TO DATE PLEASE VISIT OUR HELP DESK AT WWW.ECCOTEMP.COM FOR ALL OF OUR PRODUCT MANUALS.





ECCOTEMP
THE FUTURE OF EFFICIENCY

PHONE: 866-356-1992 | EMAIL: SUPPORT@ECCOTEMP.COM | ADDRESS: 315 - A INDUSTRIAL RD SUMMERVILLE, SC 29483 | WEBSITE: ECCOTEMP.COM



PRODUCT SUPPORT: ECCOTEMP.COM/HELP-DESK



SHOP ONLINE: ECCOTEMP.COM/PRODUCT



STORE LOCATOR: ECCOTEMP.COM/LOCATOR

