

Parts List

Item No.	Qty.	Description
①	1	Tower
②	1	Lift Arm
③	1	Base
④	2	Wheel
⑤	2	Wheel Pad
⑥	2	Lift Arm Insert

Item No.	Qty.	Description
⑦	1	Grip Handle
⑧	1	Ratchet Release Handle
⑨	1	Winch
⑩	1	Winch Handle
⑪	2	Support Rod
⑫	2	Safety Strap

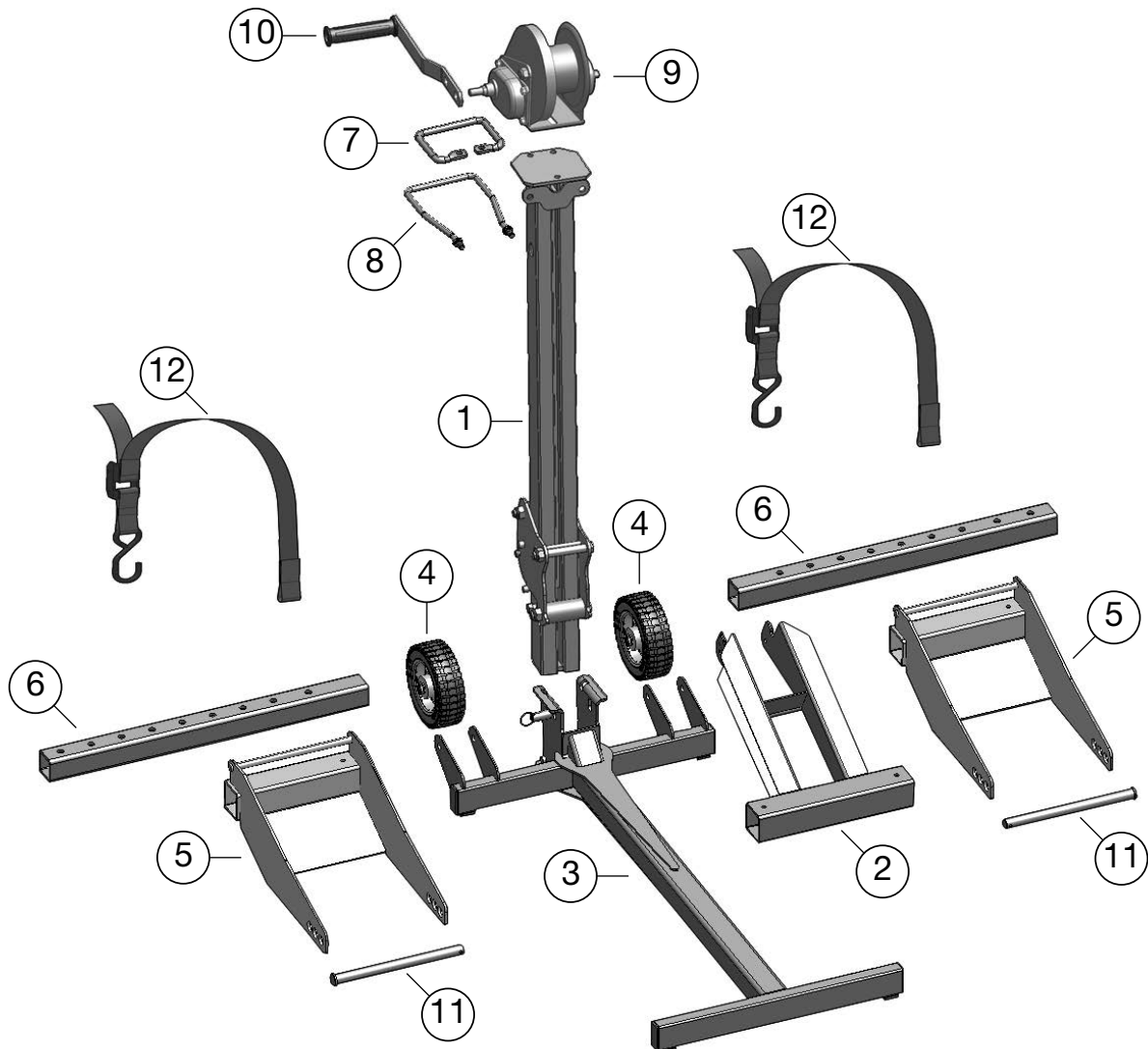

Hardware List

Item No.	Qty.	Description	Item No.	Qty.	Description
⑬	2	Cap Screw – M12-1.75 x 85	⑲	1	Winch Handle Washer – 12mm
⑭	4	Nylock Nut – M12-1.75	⑳	1	Clevis Pin
⑮	1	Cap Screw – M12-1.75 x 95	㉑	4	Push Pin
⑯	3	Cap Screw – M10-1.5 x 30	㉒	3	Hair Pin
⑰	5	Nylock Nut – M10-1.5	㉓	1	Cap Screw – M14-2.0 x 100
⑱	3	Winch Washer – 10mm	㉔	1	Nylock Nut – M14-2.0

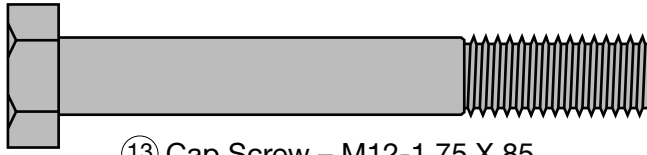

⑬ Cap Screw – M12-1.75 X 85



⑭ Nylock Nut – M12-1.75

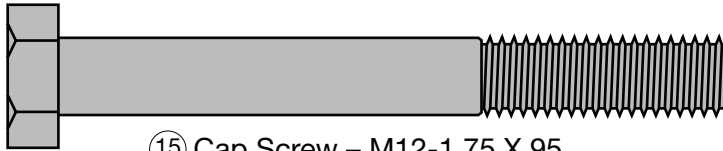

⑮ Cap Screw – M12-1.75 X 95

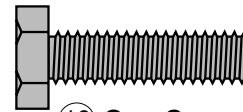

⑯ Cap Screw – M10-1.5 X 30



⑰ Nylock Nut – M10-1.5



⑱ Winch Washer – 10mm

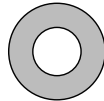

⑲ Winch Handle Washer – 12mm

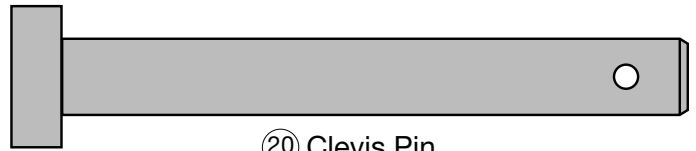

⑳ Clevis Pin

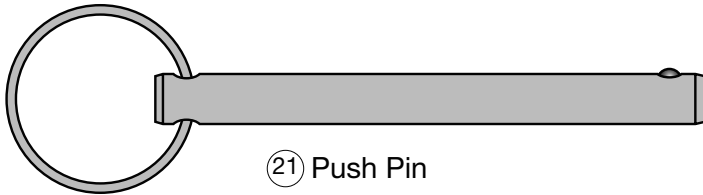

㉑ Push Pin

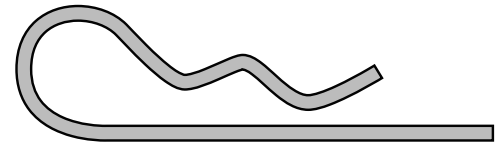

㉒ Hair Pin

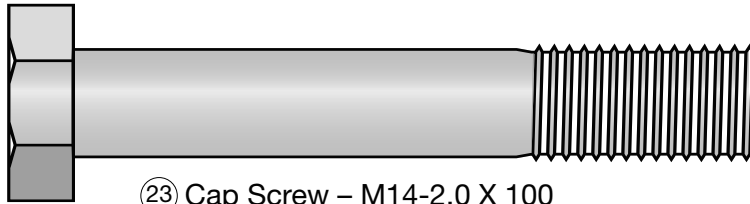

㉓ Cap Screw – M14-2.0 X 100

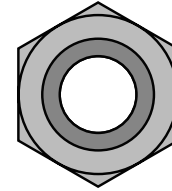

㉔ Nylock Nut – M14-2.0

Tools Needed for Assembly

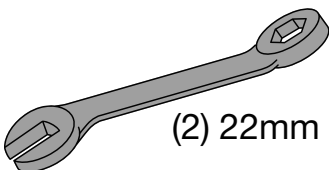

(2) 22mm Wrench

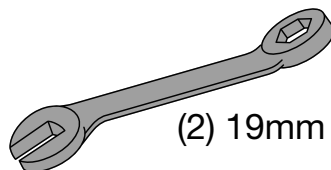

(2) 19mm Wrench

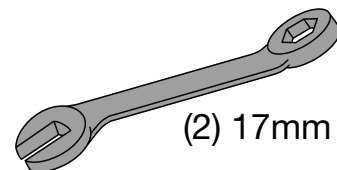

(2) 17mm Wrench