

## USE AND CARE GUIDE

---

### 3 LIGHT LED AC CCT PUCK LIGHT KIT ( WHITE AND BLACK FINISH )

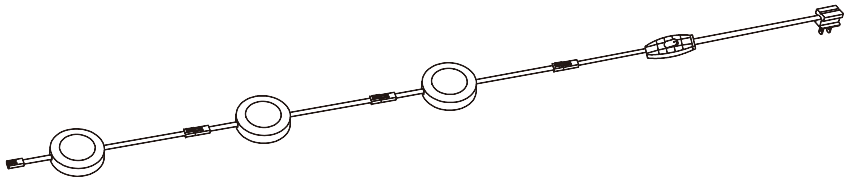

Questions, problems, missing parts? Before returning to the store,  
call Commercial Electric Customer Service  
8 a.m. – 7 p.m., EST, Monday - Friday, 9 a.m. - 6 p.m., EST, Saturday

**1-877-527-0313**

**HOMEDEPOT.COM**

---

**THANK YOU**

*We appreciate the trust and confidence you have placed in Commercial Electric through the purchase of this LED puck light kit. We strive to continually create quality products designed to enhance your home. Visit us online to see our full line of products available for your home improvement needs. Thank you for choosing Commercial Electric!*

# Table of Contents













Table of Contents .....2  
 Safety Information .....2  
 Warranty .....3  
     Planning Installation .....3  
     Tools Required .....3  
     Hardware Included .....3  
     Package Contents .....4

Installation - Surface Mounting ..... 5  
 Installation - Recessed Mounting ..... 7  
 Direct Wire Installation (optional) ..... 7  
 Installing the Quick Connector Plug (optional)..... 7

# Safety Information

1. Read all instructions carefully before you begin this installation.
2. This equipment has been tested and found to comply with the limits for a Class B digital device, pursuant to part 15 of the FCC Rules. These limits are designed to provide reasonable protection against harmful interference in a residential installation. This equipment generates, uses and can radiate radio frequency energy and, if not installed and used in accordance with the instructions, may cause harmful interference to radio communications.
3. There is no guarantee that interference will not occur in a particular installation, if this equipment does cause harmful interference to radio and television reception, which can be determined by turning the equipment off and on, the user is encouraged to try to correct the interference by one or more of the following measures: a) Reorient or relocate the receiving antenna, b) Increase the separation between the equipment and the receiver, c) Connect the equipment into a different outlet and circuit from the receiver outlet and circuit, d) Consult the dealer or an experienced radio/TV technician for help.
4. Change or modification to this unit not expressly approved by the party responsible for compliance could void the user's authority to operate the equipment.
5. Rated at 120V/60Hz, 3.2W x 3, Max. 3.2W x 30
6. Linkable, add up to 30 units.
7. The product is dimmable and can be used with a dimmer switch. See compatible dimmer list this manual.
8. Suitable for recess mounting only inside a cabinet.
9. Suitable for surface mounting only inside a cabinet.
10. Compatible with Direct Wire Junction Box (SKU1006126385), sold separately.

 Supplier's Declaration of Conformity  
 47 CFR § 2.1077 Compliance  
 Information  
 Unique Identifier: 22343KIT-WH, 22343KIT-BK  
 Responsible Party:  
 Buckingham  
 7390 McGinnis Ferry Road  
 Suite 200  
 Suwanee, GA 30024  
 Tel: 678-765-2995

-  **WARNING:** Deviation from the assembly instructions may result in a risk of fire or electric shock.
-  **CAUTION:** The National Electrical Code (NEC) does not permit cords to be concealed where damage to insulation may go unnoticed. To prevent fire danger, do not run the cord behind walls, ceilings, soffits, or cabinets where it may be inaccessible for examination. Cords should be visually examined periodically and immediately replaced when any damage is noted.
-  **CAUTION:** For indoor and dry location use only.
-  **CAUTION:** To reduce the risk of fire, electric shock, or injury to persons use only insulated staples or plastic ties to secure cords. Route and secure cords so that they will not be pinched or damaged when the cabinet is pushed to the wall.
-  **CAUTION:** Do not operate the fixture with a missing or damaged cover or housing.
-  **CAUTION:** To prevent the risk of fire, do not install each puck LED lamp in a compartment smaller than 12 in. x 12 in. x 12 in.
-  **CAUTION:** Not intended for recessed installation in ceilings, or soffits.
-  **CAUTION:** The LED source cannot be replaced.
-  **CAUTION:** Do not mount this fixture near heat sources which may damage this fixture.
-  **CAUTION:** Do not stare directly into the LED source.
-  **CAUTION:** Do not dismantle or alter this fixture.
-  **CAUTION:** To prevent electric shock, match wide blade of plug to wide slot.
-  **CAUTION:** Use only with portable cabinet light accessory providing ten foot total cord length.

# Warranty

## LIMITED WARRANTY

The manufacturer warrants this product to be free from defects in materials and workmanship for a period of five (5) years from date of purchase. This warranty applies only to the original consumer purchaser and only to products used in normal use and service. If this product is found to be defective, the manufacturer's only obligation, and your exclusive remedy, is the repair or replacement of the product at the manufacturer's discretion, provided that the product has not been damaged through misuse, abuse, accident, modifications, alterations, neglect or mishandling. This warranty shall not apply to any product that is found to have been improperly installed, set-up, or used in any way not in accordance with the instructions supplied with the product. This warranty shall not apply to a failure of the product as a result of an accident, misuse, abuse, negligence, alteration, or faulty installation, or any other failure not relating to faulty material workmanship. The manufacturer specifically disclaims any liability and shall not be liable for any consequential or incidental loss or damage, including labor/expense costs involved in the replacement or repair of said product.

Contact the Customer Service Team at 1-877-527-0313 or visit [HOMEDEPOT.COM](http://HOMEDEPOT.COM).

# Pre-installation

## PLANNING INSTALLATION

Read all instructions completely before you begin installation.

## TOOLS REQUIRED



Phillips  
screwdriver



Drill

## HARDWARE INCLUDED



**NOTE:** Hardware not shown to actual size.



AA



BB

Part	Description	Quantity
AA	Mounting screw	10
BB	Fastener	12

# Pre-installation (continued)

## PACKAGE CONTENTS

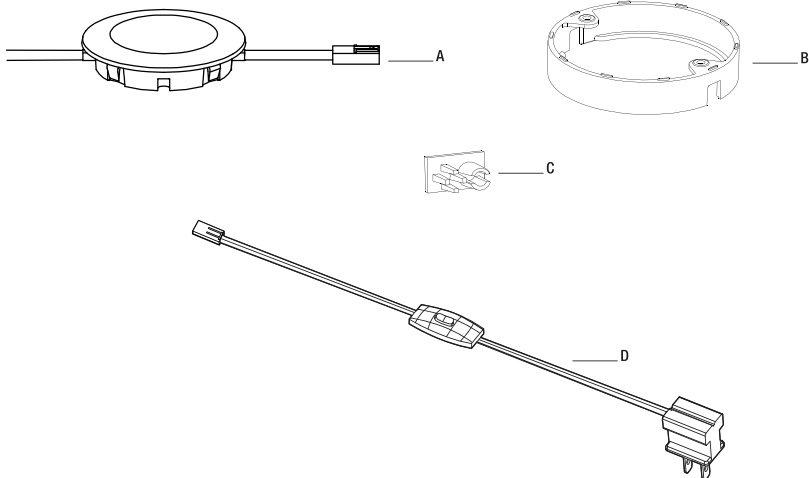

Part	Description	Quantity
A	LED puck assembly	3
B	Trim ring (preassembled to LED puck assembly (A))	3
C	End cap (preassembled to one LED puck assembly (A))	1
D	Power cord	1

## DIMMER COMPATIBILITY

This fixture is dimmable and compatible with the dimmers listed below that are sold at The Home Depot.

- Make sure the lights are in a single loop and on a single pole with the dimmers, and the total wattage of the lights does not exceed the dimmer wattage capacity. Please refer to wattage capacity on the dimmer packaging.
- Please contact customer service if you have any further questions on the lights or dimmers.

Model#/SKU# :

- Lutron Brand:** DVCL-153PR-WH/ 396508  
CTCL-153PDH-WH/ 267858  
TGCL-153PH-WH/ 527401  
MACL-153MH-WH/ 739664  
DVWCL-153PH-WH/530826
- Leviton Brand:** R62-06674-P0W/ 125569  
R12-06672-1LW/ 1000024040  
R50-IPL06-10M/ 976708
- Eaton Brand:** AAL06-C1/ 206469427  
SAL06P-LA-K/ 205462307

## Luminous Intensity Distribution

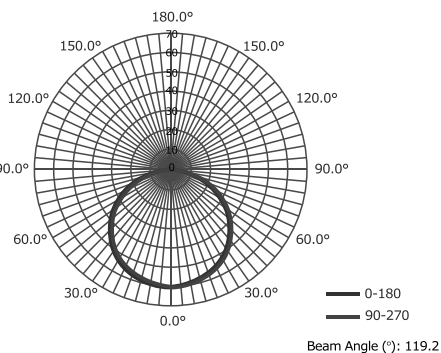

# Installation - Surface Mounting

## 1 Preparing the lights for the first time

- Separate the trim ring (B) by pushing on the back of the LED puck assembly (A).

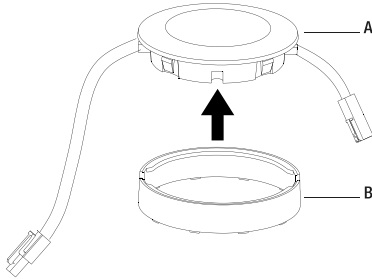

## 2 Select Color temperature

- Select color temperature in the back of the LED puck assembly (A) before installing, using the CCT switch. The three selectable color temperatures are 2700K (Warm white)/3000K (Soft white) / 4000K (Bright white).

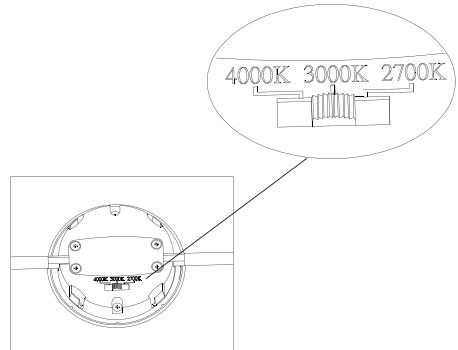

## 3 Installing the trim rings

- Attach the trim ring (B) to the desired surface, and mark the screw location. The direction of the outlet hole is the same as the screw location, make sure it meets your requirement.
- Pre-drill holes in the mounting surface with a 1/16 in. (1.5mm) drill to make installing screws easier.
- Install the trim ring (B) to the underside of the cabinet by inserting two mounting screws (AA) into the mounting holes on the bottom of each trim ring (B).

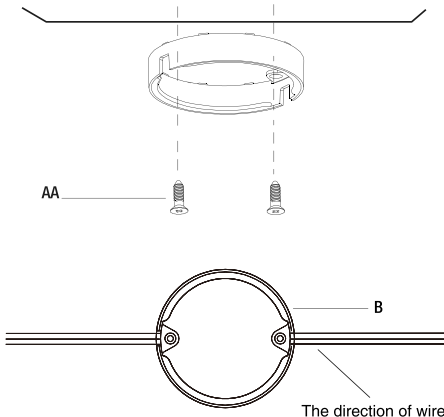

## 4 Installing the first LED assembly

- Push the LED puck assembly (A) into the trim ring (B).

 **NOTE:** Ensure the first LED assembly does not have the end cap (C).

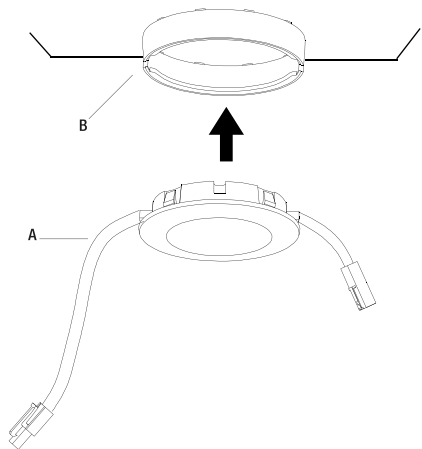

## Installation - Surface Mounting (continued)

### 5 Installing the remaining two LED assemblies

- Repeat steps 1 through 4 to install the remaining two LED puck assemblies (A).



**NOTE:** Make sure the LED puck assembly (A) with end cap (C) is the last puck installed.

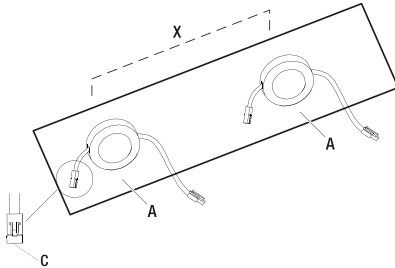

### 6 Connecting the LED puck lights

- Connect the LED puck assemblies with each other. Connect the power cord (D) to the fixtures.

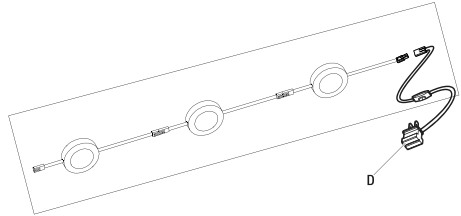

### 7 Securing the cords

- Use nail-on fasteners (BB) to attach the wire to the cabinet.

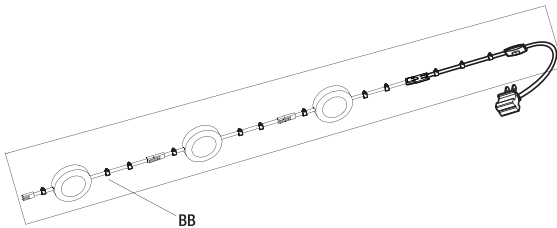

# Installation - Recessed Mounting

## 1 Preparing the lights for the first time

- Repeat steps 1 through 2 in the Surface Mounting installation section of this document.
- Drill a hole using a 2.75 in. holesaw into the installation area.



**IMPORTANT:** Make sure you measure the distance between the puck light assemblies (A) before drilling installation holes.

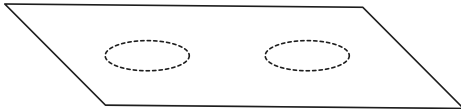

## 2 Inserting the LED lights

- Thread the wire from the LED puck assembly (A) through the hole and insert the fixture into the hole. Repeat steps 1 through 2 in the Surface Mounting section for the remaining two LED assemblies (A).
- Connect the LED puck assemblies (A) with each other and connect the power cord (D) as described in step 6 in the surface mounting installation section.

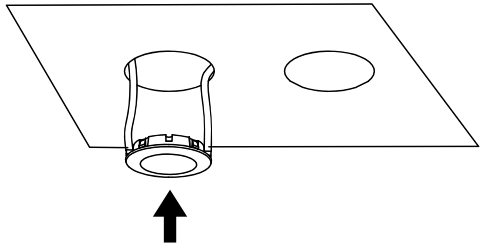

## Direct Wire Installation (optional)

### Convert to Direct Wire:

- Directly wire this fixture to a wall switch using Direct Wire junction Box (SKU1006126385), sold separately.

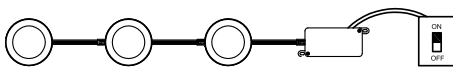

## Installing the Quick Connector Plug (optional)

- The fixture wire (1) can be cut to the desired length if necessary. This helps to minimize the amount of wire underneath the cabinets.
- Remove the plug cover (2) from the plug (3).
- Press the fixture wire (1), with grooved side (4) to the right (neutral side) down and into the front of the plug (3).
- Press the fixture wire (1) down onto the metal prongs.
- Slide the plug cover (2) back onto the plug over the fixture wire (1).

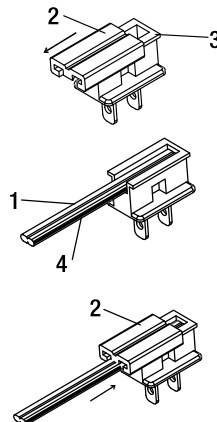



Questions, problems, missing parts? Before returning to the store,  
call Commercial Electric Customer Service  
8 a.m. – 7 p.m., EST, Monday - Friday, 9 a.m. - 6 p.m., EST, Saturday

**1-877-527-0313**

**HOMEDEPOT.COM**

Retain this manual for future use.