

How to build a staircase like a pro.

SUREWOOD~LNL

Over-The-Post System



Easy step-by-step instructions to help you achieve professional results

www.surewood-lnl.com

1 Identify Your Type of Post-to-Post Staircase:



Post-To-Post Staircase System

Landing Newel Post

Starting Newel Post

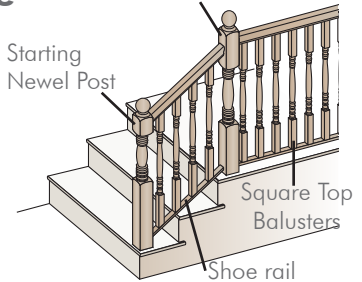

Open Staircase with Square Top Balusters and Shoe rail

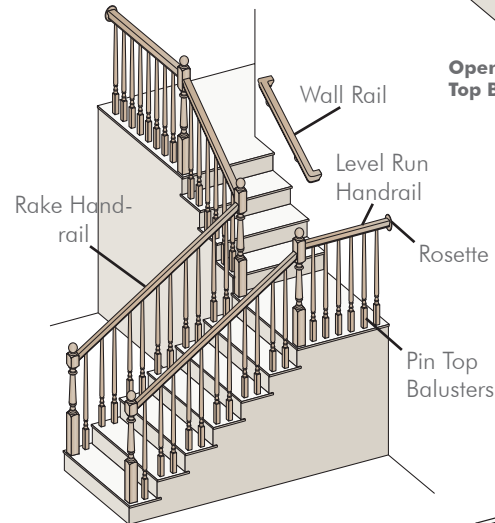

Open Staircase with Pin Top Balusters

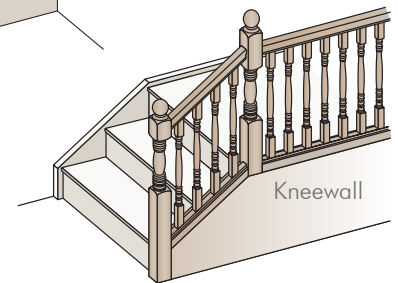

Closed Staircase with Square Top Balusters and Kneewall

Straight

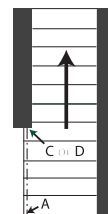

Determine the parts needed.

"U" - Shaped

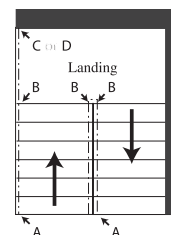

Legend

A - Starting Newel
B - Landing Newel

"L" - Shaped

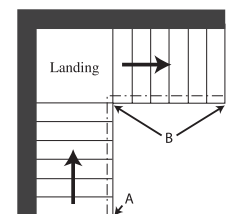

C - Rosette
D - Half Newel

2

Selecting Your Parts:

There are several styles and options for your treads, risers, balusters and newel posts. Below are the most common. Other items are available by special order. Check with your store representative.

Balusters, Newel Posts, Handrails, and Shoe rails:

Pin Top Baluster:



Square Top Baluster:

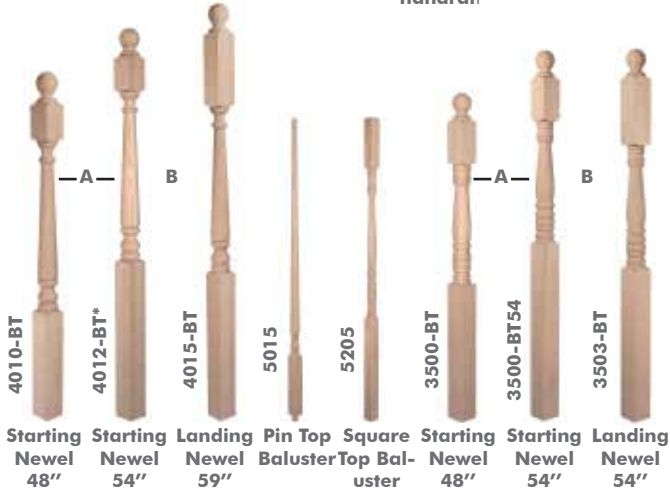

Treads and Risers: Wall Rails and Handrail Ends:



Wall Rail Brackets:



c Rosettes:

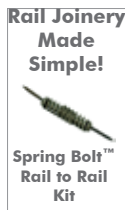

d Half Newel:

For Wall Finishing
Half newels available to match newel style.

3

Post-to-Post Staircase Parts Checklist:

Check local building codes to ensure compliance. All stair parts shown in this brochure are for interior use only.

	Part #	Qty
Treads - Select one tread for each step.	_____	_____
Risers - Select one riser for each step. Select one more riser than treads per each staircase.	_____	_____
Landing Tread - Select sufficient lineal footage for the entire balcony and width of stairs at each landing.	_____	_____
Return Nosing - If stair is open on one side, select one tread return nosing per step. If two-sided, select two per step.	_____	_____
Starting Newel* - Use at the bottom of the staircase.	_____	_____
Landing Newel* - Use at the landing corner of an L-shaped stair and at the second floor landing.	_____	_____
Level Run Newel* - If the balcony is 10 feet or longer, use a newel every 5 or 6 feet. Place a newel at every corner. The Landing Newel may be used, but be sure to match the top block with the newel used at the top of the stairway for consistency.	_____	_____
Rosette or Half Newel - Select either a rosette or half newel for each handrail connecting to a wall.	_____	_____
Newel Mounting Hardware - Select one newel mounting kit for each newel post mounted on top of a tread.	_____	_____
Rake Balusters* - Select the 34" baluster for the front baluster on each tread and the 36" baluster for the back baluster on each tread. If using 3 balusters per tread, use the 36" baluster for the middle baluster on each tread.	_____	_____
Rake Balusters for Kneewall Staircase* - Select the 34" baluster at a rate of 2 per tread. Standard placement is 4" on center. Check local building code for your area.	_____	_____
Level Run Balusters* - Use the 36" baluster for all 36" height balconies and the 41" baluster for all 41" height balconies. Standard placement is 4" on center. Check local building code for your area.	_____	_____
Handrail - Buy 13" of handrail for each tread or step. Buy enough for all level runs.	_____	_____
Shoe rail for Rake - Buy 13" of corresponding shoe rail for each tread or step (shoe rail or kneewall stairs only).	_____	_____
Shoe rail for Balcony (optional) - Buy enough to cover all Level Runs.	_____	_____
Plugs - Select two wood plugs for every newel mounting using lag bolts. Select one plug for each handrail rail bolt used. Select one plug for every handrail or shoe rail mounting using a lag bolt or wood screw.	_____	_____
*Note: These guidelines are for a rake handrail height of 36"-41". Longer newels and balusters may be required for a different handrail height.		

4

Tools Required:

Operation:

Measuring and Leveling

Metal measuring tape, hand levels, (torpedo and 4' level), framing square

Cutting

Miter box and saw (fine-tooth) hand or power circular saw or standard hand saw

Nailing

Hammer, nail set, 1/2" and 1" finishing nails

Gluing

Carpenter's glue and construction adhesive

Screw Driving

Screwdriver (manual or power), 3" wood screws

Drilling

Hand drill, drill guide and 1/8", 1/4", 3/8", 5/8", 3/4", 1" wood bits

Finishing

Sandpaper, steel wool, wood file, wood chisel, finishing stain, rags, tack cloth, etc.

5

Getting Started - Tread and Riser Installation:

To properly install solid oak treads and risers, you must first remove the existing steps to expose the rough framing. Leave the beginning riser at base of steps (A). Measure and cut each step separately to ensure tight fit. (B). Pre-drill, apply construction adhesive and nail into place. For added strength, screw treads to risers from behind (C). Complete each step before continuing on to next step.

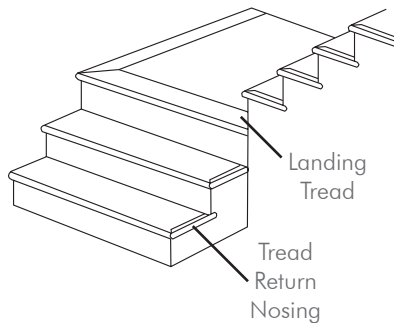
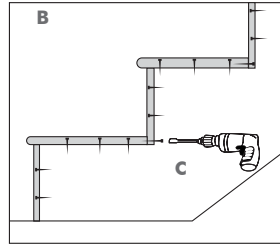
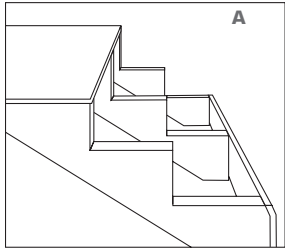

Landing Tread
Landing tread can be used with 3/4" oak flooring along a landing when solid oak treads and risers are used. Landing tread can be used along a balcony with oak flooring. Properly cut miters and attach directly to sub floor.

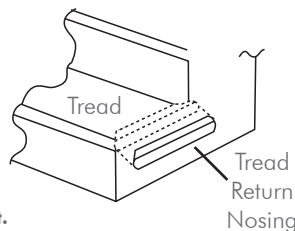

Tread Return Nosing Installation

Cut and miter tread return nosing to fit. Adds a finished look to the tread edge.

6

Basic Layout and Newel Post Installation:

Marking Your Staircase for Installation

Layout your staircase directly on your treads and landings. Carefully mark Newel and Baluster positions and centerlines.

Starting Newel Height

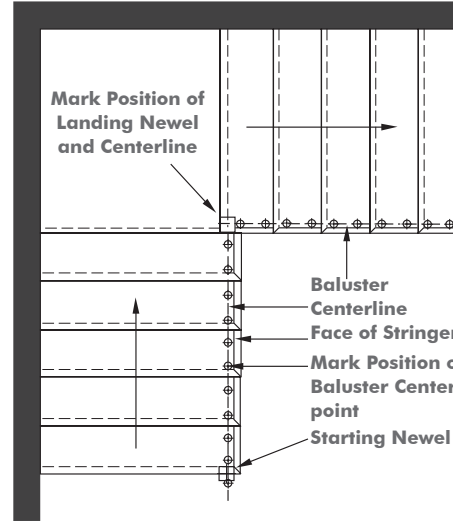
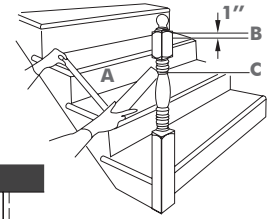

With newel in position where it is to be mounted, slide short end of framing square along slope of stairway.

A) Slide into post as shown. Make mark.

B) Measure down 1" from top of newel square. Make mark.

C) The difference between the two marks "A" and "B" is what will be cut off bottom of newel. Proceed with newel installation.

Landing Newel Height

A) Height of the handrail should be between 36" and 42". Check local building codes.
B) Place the top of the handrail one inch below the top block of the newel.

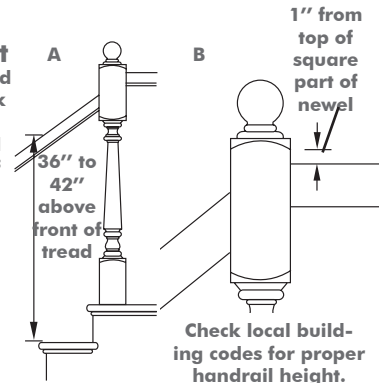

Newel Post Attachment

Trim and Fasten the Newel Posts

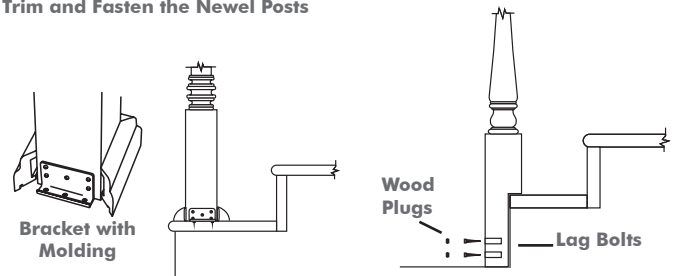

7a Attaching Handrail for Pin Top Balusters:

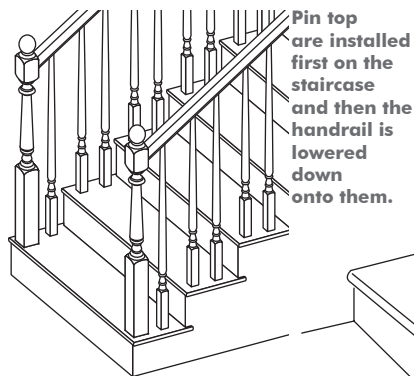

Pin top are installed first on the staircase and then the handrail is lowered down onto them.

A) Mark baluster placement on treads allowing for equal spacing.

Drill treads the same size and depth as pin on bottom of baluster.

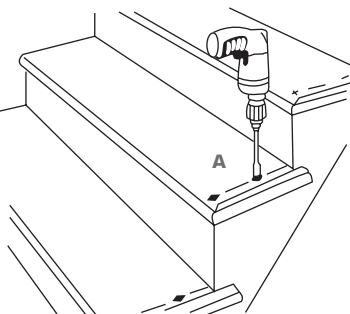

B) Lay handrail along stairs allowing extra length for proper fit to newels. Using framing square, transfer tread markings to side of handrail. Transfer markings to bottom center of handrail.

C) Locate baluster holes in solid handrail. Mark center of handrail.

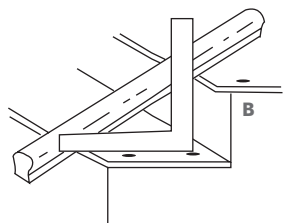

C
Mark Handrail Here

D) Rotate handrail 180° on stairs so balcony side of handrail is at base of stairs. Drill holes using 5/8" drill bit a minimum of 3/4" deep into handrail. Use drill guide set to proper angle.

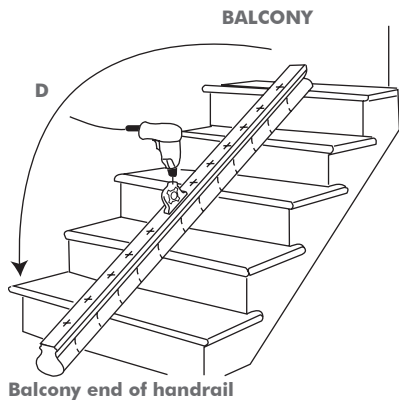

Balcony end of handrail

E) Using newels as guide, mark handrail and cut to proper length. Follow instructions for attaching newels.

For balconies, follow same procedures, keeping handrail on flat surface when drilling.

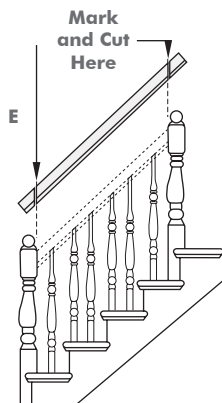

7b Attaching Handrail for Square Top Balusters:

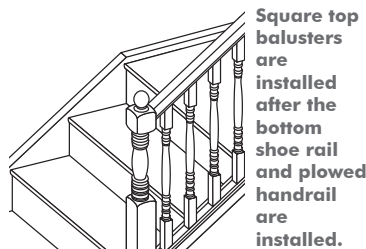

Square top balusters are installed after the bottom shoe rail and plowed handrail are installed.

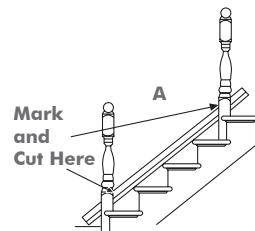

A) Lay handrail and shoe rail along stairs, marking where they intersect with newels. Place rail on side and cut along marks.

B) Attach handrail using option #1 (3" wood screws) or option #2 (4-1/2" lag bolts through front of rail). Both options require pre-drilling a pilot hole. Attach shoe rail using option #1 (3" wood screws), option #2 (toe-nailed finishing nails) or option #3 (screwed to kneewall).

Handrail

Shoe rail

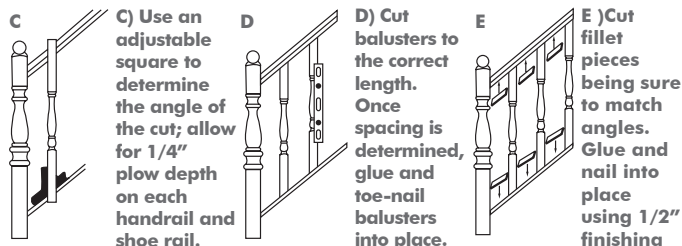
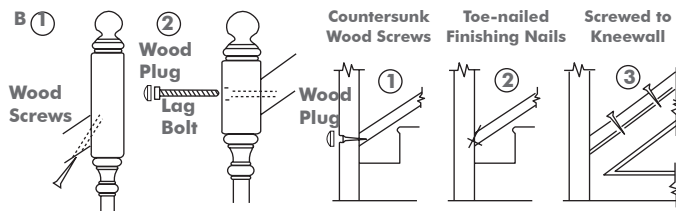

*Most codes require 4" on center spacing. Check your local municipality for all applicable building codes.

8 Finish to Wall and Wall Rail Installation:

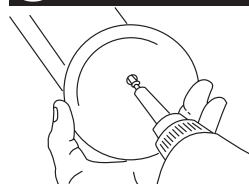

Attach rosette or half newel directly to handrail as shown. Secure first to handrail using nails or screws, then secure to wall.

Wall Rail Styles:

6042 Wall Rail with bracket

6010-S Handrail w/ 7011 Quarter-turn

6010-S Handrail w/ 7009 Returned End

How to build a staircase like a pro.

 SUREWOOD~LNL

Over-The-Post System

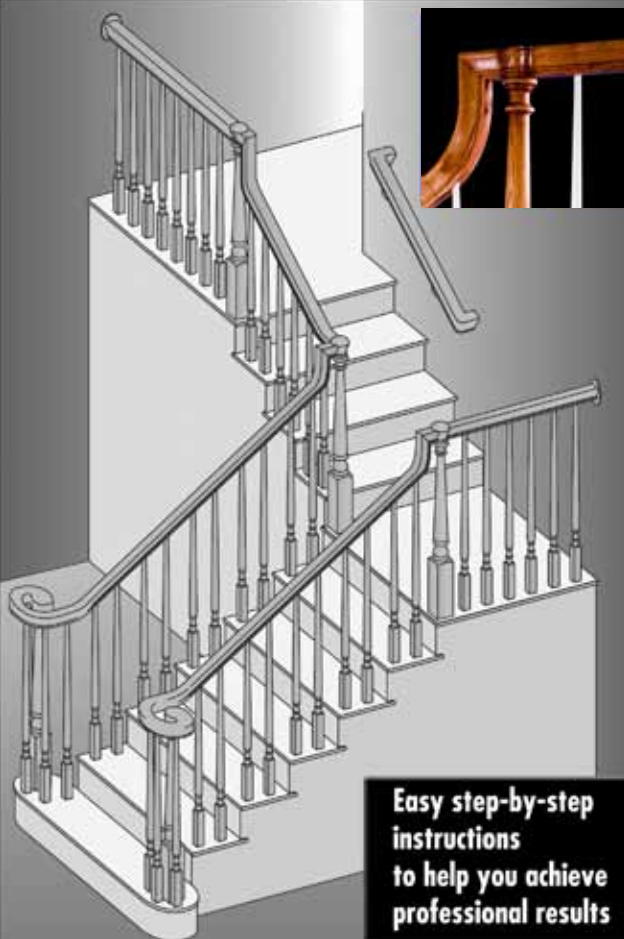

Easy step-by-step instructions to help you achieve professional results

www.surewood-lnl.com

1

Identify Your Type of Over-The-Post Staircase:



Over-The-Post Staircase System

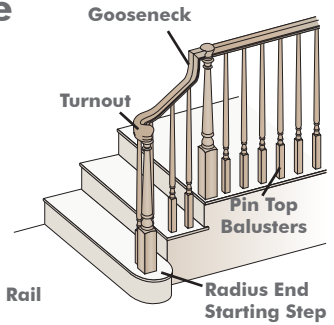

Open Staircase with Turnout Starting Fitting

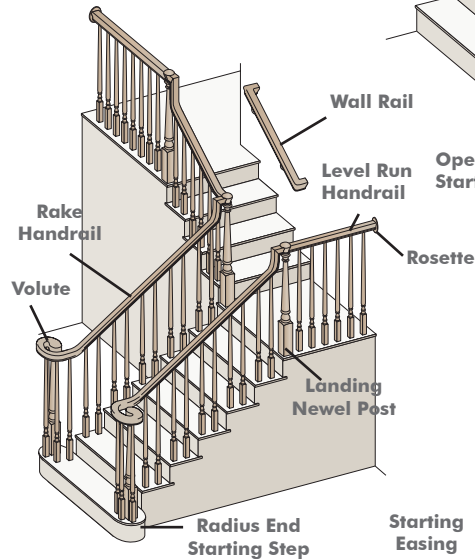

Open Staircase with Volute Starting Fitting

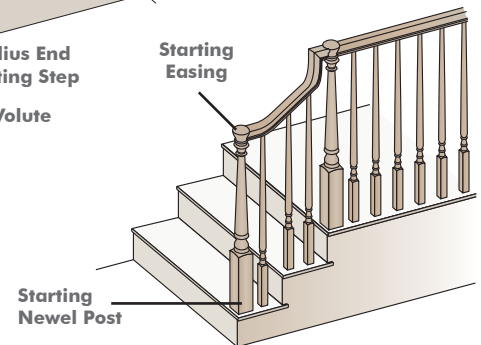

Open Staircase with Starting Easing Fitting

Straight

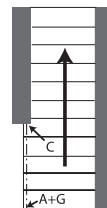

Determine the parts needed.

"U" - Shaped

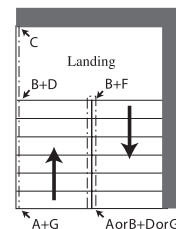

Legend
A - Starting Newel
B - Landing Newel
C - Rosette

"L" - Shaped

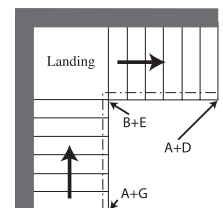

D - Straight Gooseneck
E - 90° Gooseneck
F - 180° Gooseneck
G - Starting Fitting

2

Selecting Your Parts:

There are several styles and options for your treads, risers, balusters and newel posts. Below are the most common. Other items are available by special order. Check with your store representative.

Balusters, Newel Posts:

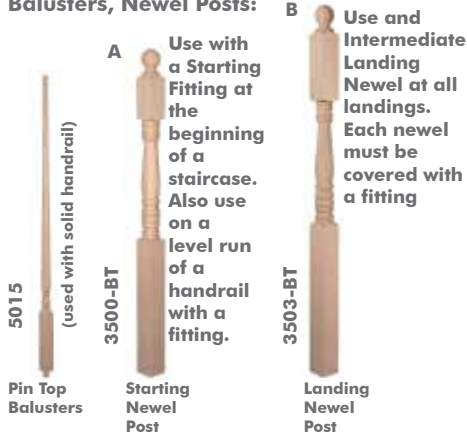

Rosettes:



Mounting Hardware:



Treads and Risers:



Handrail, Ends and Wall Rails:



Wall Rails Brackets:



Choose Fitting Style:



Make Gooseneck transition using these parts:



Rail Joinery Made Simple!



Each pin top newel post must be covered with a fitting. The floor plans to the left illustrate the fitting components needed for each landing situation.

Choose Starting Fitting:



Build a Starting Easing



Use at the bottom of the stairway over the Starting Newel. Volutes and Turnouts are available left hand or right hand.

3

Post-to-Post Staircase Parts Checklist:

Check local building codes to ensure compliance. All stair parts shown in this brochure are for interior use only.	Part # Selected	Quantity Needed
Treads - Select one tread for each step.	_____	_____
Risers - Select one riser for each step (except the starting step). Select one more riser than treads per each staircase.	_____	_____
Landing Tread - Select sufficient lineal footage for the entire balcony and width of stairs at each landing.	_____	_____
Return Nosing - If stair is open on one side, select one tread return nosing per step. If two-sided, select two per step.	_____	_____
Starting Fitting - Select either a Volute, Turnout, or Starting Easing.	_____	_____
Starting or Landing Newel* - Use at the bottom of the stairway and at the second floor landing. If the balcony is 10 feet or longer, use the starting newel every 5 or 6 ft. Place a newel at every corner under a quarterturn.	_____	_____
Intermediate Landing Newel* - Use at the intermediate landing corner of a U- or L-shaped stair.	_____	_____
Rosette - Select a rosette for each handrail connection into a wall.	_____	_____
Newel Mounting Hardware: - Select one newel mounting kit for each newel post mounted on top of a tread.	_____	_____
Balusters for Starting Fittings* - Each volute requires (6) 1-1/4" x 41" balusters, or (4) 1-1/4 or 1-3/4" x 41" balusters. Each turnout requires (2) 1-1/4" x 41" balusters or (1) 1-3/4" x 41" baluster. Each starting easing requires (1) 41" baluster.	_____	_____
Rake Balusters* - Select the 34" baluster for the front baluster on each tread and the 36" baluster for the back baluster on each tread. If using 3 balusters per tread, use the 36" baluster for the middle baluster on each tread.	_____	_____
Level Run Balusters* - Use the 36" baluster for all 36" height balconies and the 41" baluster for all 41" height balconies. Standard placement is 4" on center. <u>Check local building code for your area.</u>	_____	_____
Handrail - Buy 13" of handrail for each tread or step. Buy enough for all level runs.	_____	_____
Plugs - Select two wood plugs for every newel mounting using lag bolts. Select one plug for each handrail rail bolt used.	_____	_____
Handrail Mounting Hardware - Select one Rail Bolt Kit or Spring Bolt for each handrail-to-handrail connection required.	_____	_____
Gooseneck Fittings - Select the appropriate gooseneck fitting for each straight, U or L-shaped staircase newel.	_____	_____

*Note: These guidelines are for a rake handrail height of 36"-41". Longer newels and balusters may be required for a different handrail height.

4

Tools Required:

Operation:

Measuring and Leveling

Metal measuring tape, hand levels, (torpedo and 4' level), framing square

Cutting

Miter box and saw (fine-tooth) hand or power circular saw or standard hand saw

Nailing

Hammer, nail set, 1" finishing nails

Gluing

Carpenter's glue and construction adhesive

Screw Driving

Screwdriver (manual or power), 3" wood screws

Drilling

Hand drill, drill guide and 1/8", 1/4", 3/8", 5/8", 3/4", 1" wood bits

Finishing

Sandpaper, steel wool, wood file, wood chisel, finishing stain, rags, tack cloth, etc.

Tools Needed:

5

Getting Started - Tread and Riser Installation:

To properly install solid oak treads and risers, you must first remove the existing steps to expose the rough framing. Leave the beginning riser at base of steps (A). Measure and cut each step separately to ensure tight fit. (B). Pre-drill, apply construction adhesive and nail into place. For added strength, screw treads to risers from behind (C). Complete each step before continuing on to next step.

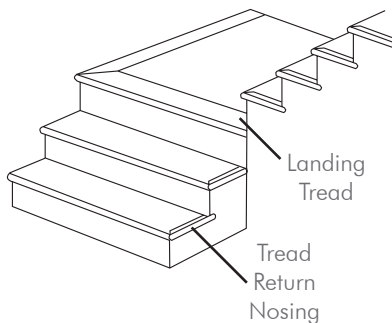
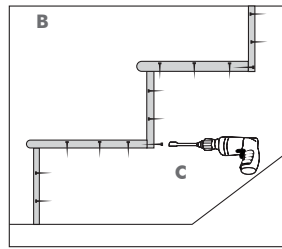
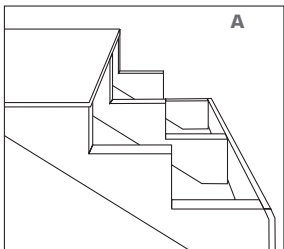

Landing Tread

Landing tread can be used with 3/4" oak flooring along a landing when solid oak treads and risers are used. Landing tread can be used along a balcony with oak flooring. Properly cut miters and attach directly to sub floor.

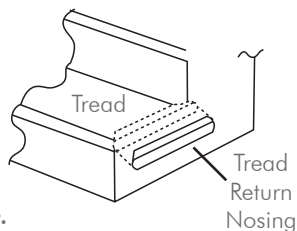

Tread Return Nosing Installation

Cut and miter tread return nosing to fit. Adds a finished look to the tread edge.

6

Basic Installation:

Marking Your Staircase for Installation

Layout your staircase directly on your treads and landings. Carefully mark Newel and Baluster positions and centerlines.

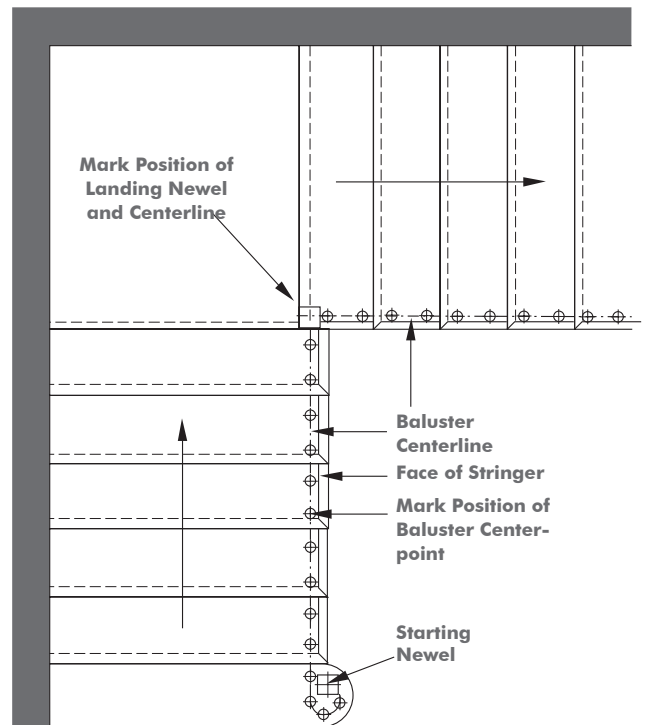

Volute Starting Fitting Layout

The balustrade centerline and newel centerpoints should be laid out. On a kneewall stair, the balustrade should be centered on the kneewall. On an open-tread stair, the centerline should be 1/2 of the baluster square in from the face of the stringer; i.e. 5/8" for a 1-1/4" baluster.

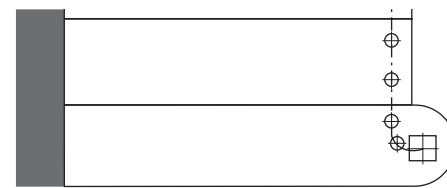

Turnout Starting Fitting Layout

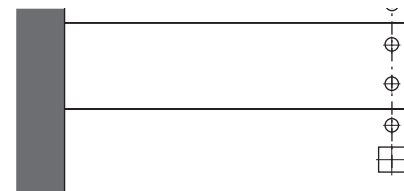

Starting Easing Fitting Layout

7

Assemble the Handrail:

Assemble the handrail on top of the stair treads prior to installing the newel posts. Use rail bolts and glue at each fitting connection. Complete instructions are included with fittings.

Rail Bolt Installation

Apply glue to ends. Assemble and install nut. Tighten nut with wrench. Fill access hole with wood plug.

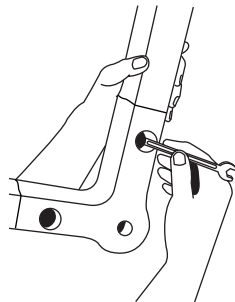
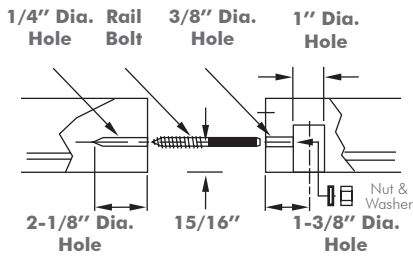

8

Newel Post Installation:

Measure and Trim Newel Posts

A. The rake rail height should be between 36"– 42" (H1) (check local building codes). B. Center the assembled handrail over the newel locations. Measure the distance between the tread and the bottom of the handrail fitting (A1 and A2). C. Also measure the rake rail thickness (T1). Use the following formula to calculate the starting newel height. D. If the newel starts from the floor or a lower tread, add that distance as well.

$$H1 + A1 - T1 = \text{Starting Newel Height}$$

Newel Post Installation

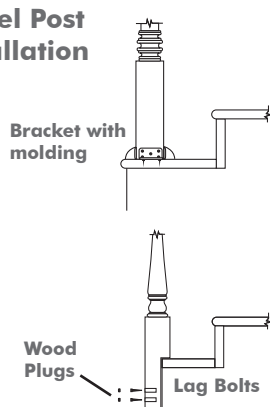
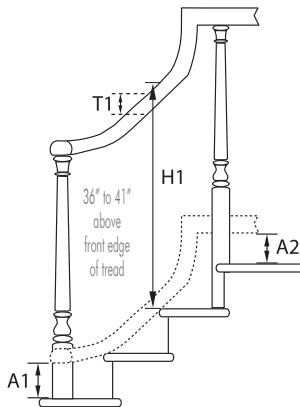

9

Installing the Balusters and Handrail:

A) Temporarily position assembled handrail onto newels.

B) Use level to mark the handrail with baluster centers.

C) While handrail is on newels, drill baluster holes in treads. Glue and insert balusters. Toenail with 1" finishing nails.

D) Remove handrail from newels and drill baluster holes in treads. Glue and insert balusters. Toenail with 1" finishing nails.

E) Apply glue to top of newels and balusters and attach handrail.

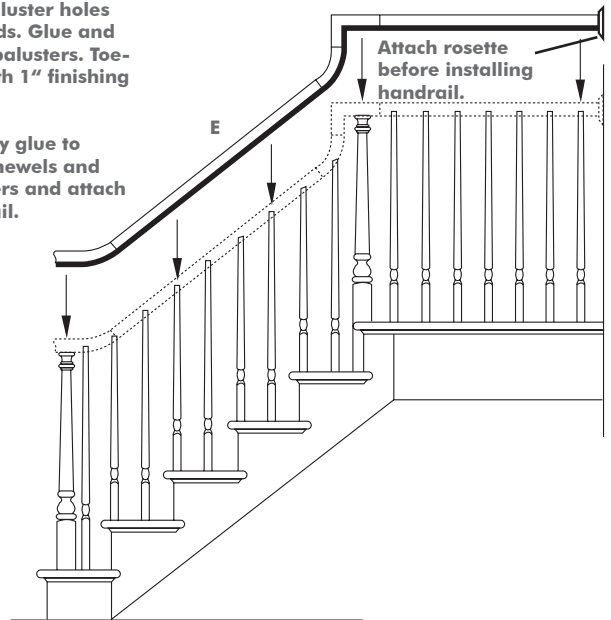
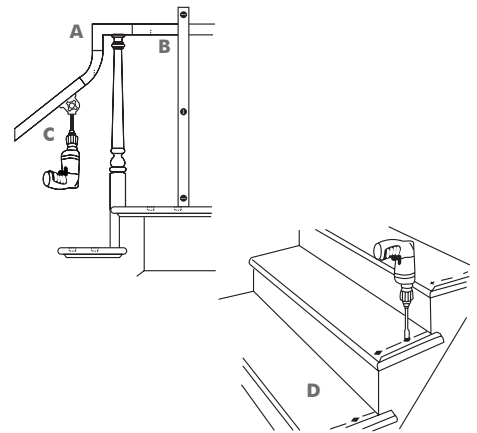

10

Finish to Wall and Wall Rail Installation:

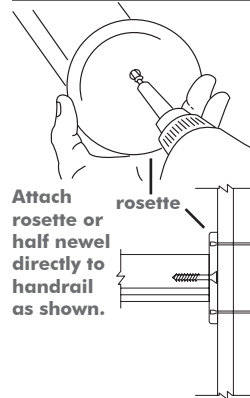

Wall Rail Styles:

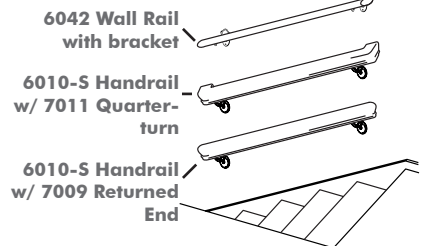

IRON BALUSTER INSTALLATION GUIDE

SUREWOOD LNL



A "How-To" Guide for the
Installation of Iron Balusters.

Iron Baluster Installation

Before proceeding with the following steps, the handrail height should already be determined. Read all the steps below before beginning installation. See "How-To Build a Staircase Like a Pro" for instructions on how to set proper handrail height.

Post-to-Post

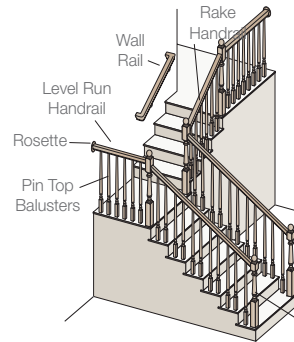

Over-the-Post

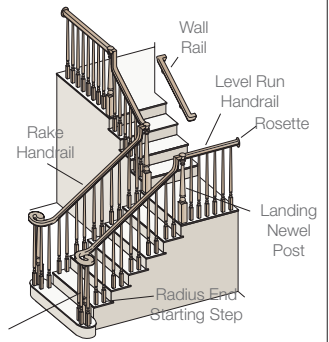

1 Tread and Riser Installation:

To properly install solid oak treads and risers, you must first remove the existing steps to expose the rough framing. Leave the beginning riser at base of steps (A). Measure and cut each step separately to ensure tight fit. (B). Pre-drill, apply construction adhesive and nail into place. For added strength, screw treads to risers from behind (C). Complete each step before continuing on to next step.

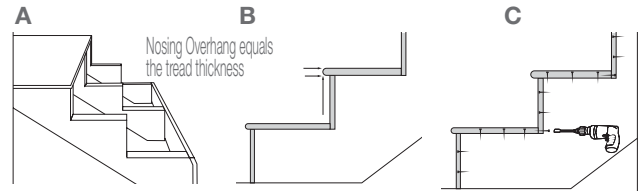

2 Basic Layout:

Marking Your Staircase for Installation Layout your staircase directly on your treads and landings. Carefully mark Newel and Baluster positions and center-lines.

Post-to-Post

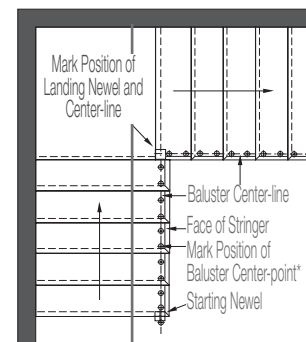

*Metal balusters should be installed no wider than 4" on center, so that a 4" sphere cannot pass through anywhere along the handrail. Check your local building codes to ensure compliance.

(Continued on next page)

2 Basic Layout (continued from last pg):

Marking Your Staircase for Installation Layout your staircase directly on your treads and landings. Carefully mark Newel and Baluster positions and center-lines.

Over-the-Post

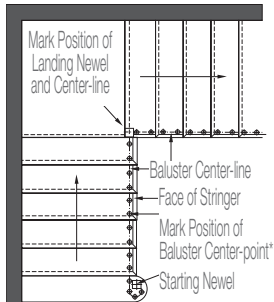

The balustrade center-line and newel center-points should be laid out. On a knee-wall stair, the balustrade should be centered on the knee-wall. On an open-tread stair, the center-line should be 1/2 of the baluster square in from the face of the stringer (i.e. 5/8" for a 1-1/4" baluster).

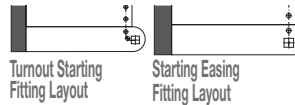

3 Newel Post Installation:

Post-to-Post

Starting Newel Height

With newel in position where it is to be mounted, slide short end of framing square along slope of stairway.

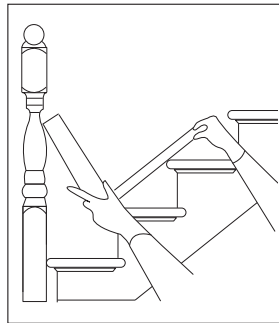
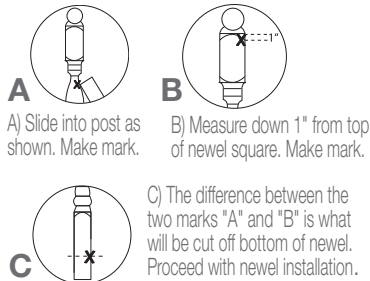

Landing Newel Height

A) Height of the handrail should be between 36" and 42". Check local building codes.

B) Place the top of the handrail one inch below the top block of the newel.

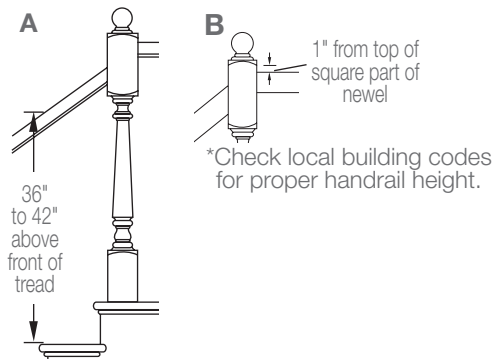

3 Newel Post Installation:

Over-the-Post

Assemble the Handrail:

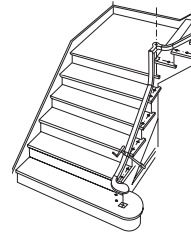

Rail Bolt Installation

Apply glue to ends. Assemble and install nut. Tighten nut with wrench. Fill access hole with wood plug.

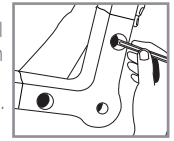

Assemble the handrail on top of the stair treads prior to installing the newel posts. Use rail bolts and glue at each fitting connection. Complete instructions are included with fittings.

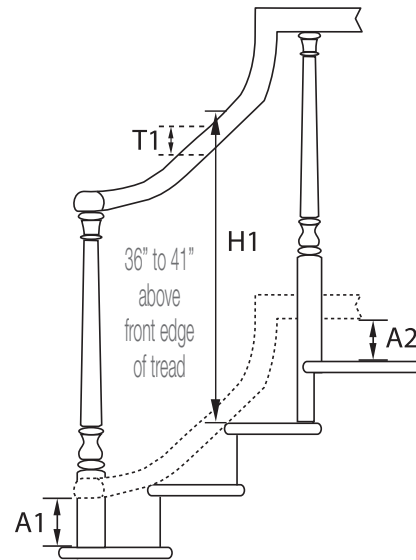
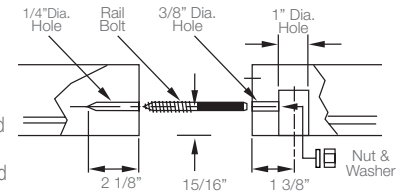

Measure and Trim Newel Posts

The rake rail height should be between 36"– 42" (H1) (check local building codes). Center the assembled handrail over the newel locations. Measure the distance between the tread and the bottom of the handrail fitting (A1 and A2). Also measure the rake rail thickness (T1). Use the following formula to calculate the starting newel height.

$$H1 + A1 - T1 = \text{Starting Newel Height}$$

If the newel starts from the floor or a lower tread, add that distance as well.

Newel Post Attachment
Trim and Fasten the Newel Posts using one of these methods

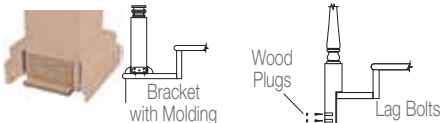

4 Measure and Trim Balusters

Mark baluster placement on treads allowing for equal spacing while following your original design. Drill holes* using 5/8" drill bit a minimum of 3/4" deep into stair treads. Make sure to keep the depths consistent.

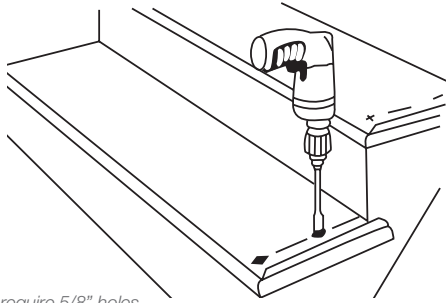

*Note: a. 1/2" balusters require 5/8" holes.
b. 5/8" balusters require 7/8" holes.

Using newels as guides, mark handrail and cut to proper length. Follow instructions for attaching newels and temporarily install handrail.

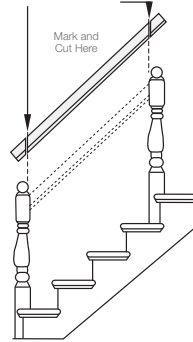

Using a plum bob, line up with the holes in the treads and mark the handrail for the top of the baluster. Drill holes using 5/8" drill bit a minimum of 3/4" deep into handrail.

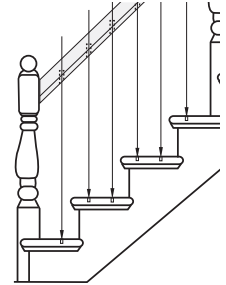

5 Trim and Install Balusters

Follow the instruction on the other side of this brochure to trim and install your Iron balusters.

Replacing Wood Balusters with Iron Balusters

Choose your look ...



2 Balusters per step*



Single Basket Baluster
Double Basket Baluster



3 Balusters per step*



Single Twist Baluster
Double Twist Baluster



Rake Shoe



Flat Shoe

*Note: Building codes vary by municipality. Check with your local authorities to ensure your project meets code in your area.

Two Methods for Removing Old Balusters:

1st Method:

1. A firm twist of the baluster may be all that is necessary to remove baluster from tread and handrail. Remove any nails remaining or fasteners.
2. Once loosened, lift the baluster up into the handrail, enough to clear the stair tread at the bottom, and then tilt it to the side and pull out from the handrail.
3. If glue and/or wood still remains in the holes, a drill with a 1/2" bit can be used to remove any excess.*



2nd Method

1. Cut baluster in half with a hand or power saw.
2. Twist each half to loosen.
3. Remove each half of the baluster from the stair tread and handrail, and any nails remaining or fasteners.
4. If glue and/or wood still remains in the holes, a drill with a 1/2" bit can be used to remove any excess.*



*Note: a. 1/2" balusters require 5/8" holes.
b. 5/8" balusters require 7/8" holes.

Installing New Balusters:

Trim Iron Balusters to fit.

1. Using a metal tape measure, measure the distance from the front hole in the stair tread to the corresponding hole in the bottom of the handrail. It may be necessary to drill the hole deeper into the handrail to accommodate the baluster. Be careful to NOT drill through top of handrail.



2. Do this same procedure for the all holes in the stair tread.



3. To each of these measurements add 1 1/2".

Example: 35" + 1 1/2" = 36 1/2"

This is your baluster length.

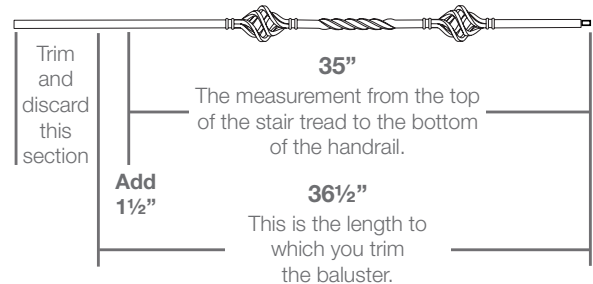

4. Using the above measurement, cut the baluster to the length needed. Be sure to cut from the bottom of your baluster. The top is the end with the rounded tip.



Baluster Top

5. A Chop Saw with a metal-cutting blade is the preferred way to cut the iron balusters. Take care when marking and cutting the balusters. Use safety glasses and follow proper safety precautions while cutting balusters. **Note:** Iron can be extremely hot after cutting.



Install and Secure Balusters

6. Before placing the balusters in the staircase, top and bottom “shoes” must be inserted on both ends. Loosen set screws to insert baluster ends. Face set screws in same direction.



Rake Shoe

7. A RAKE shoe should be placed at the top (Pin end) of each baluster. A FLAT shoe will go at the cut end of each baluster. Tighten in place a few inches from each end. This keeps them secure during placement of the baluster.



Flat Shoe

8. Make sure the “rake” of the shoe coincides with the angle of the handrail. The angle of the rake shoes may have to be adjusted with a grinder or belt sander for the best fit.



TIP: Test-fit all balusters before securing with epoxy.

9. Following manufacturers instructions, place epoxy in the stair tread hole and some on the Pin Top of the baluster.



10. Place the Pin Top into the handrail hole first and then into the stair tread hole. Straighten baluster once inserted. The Pin Top should press firmly against the front of the handrail hole, making sure that the flat shoe at the bottom squares up with the front of the step.



11. Once the epoxy has set, the rake and flat shoes can be put into position and secured with an allen wrench.

