

# ASSEMBLY INSTRUCTIONS

## TWIN/TWIN FLOOR BUNK BED

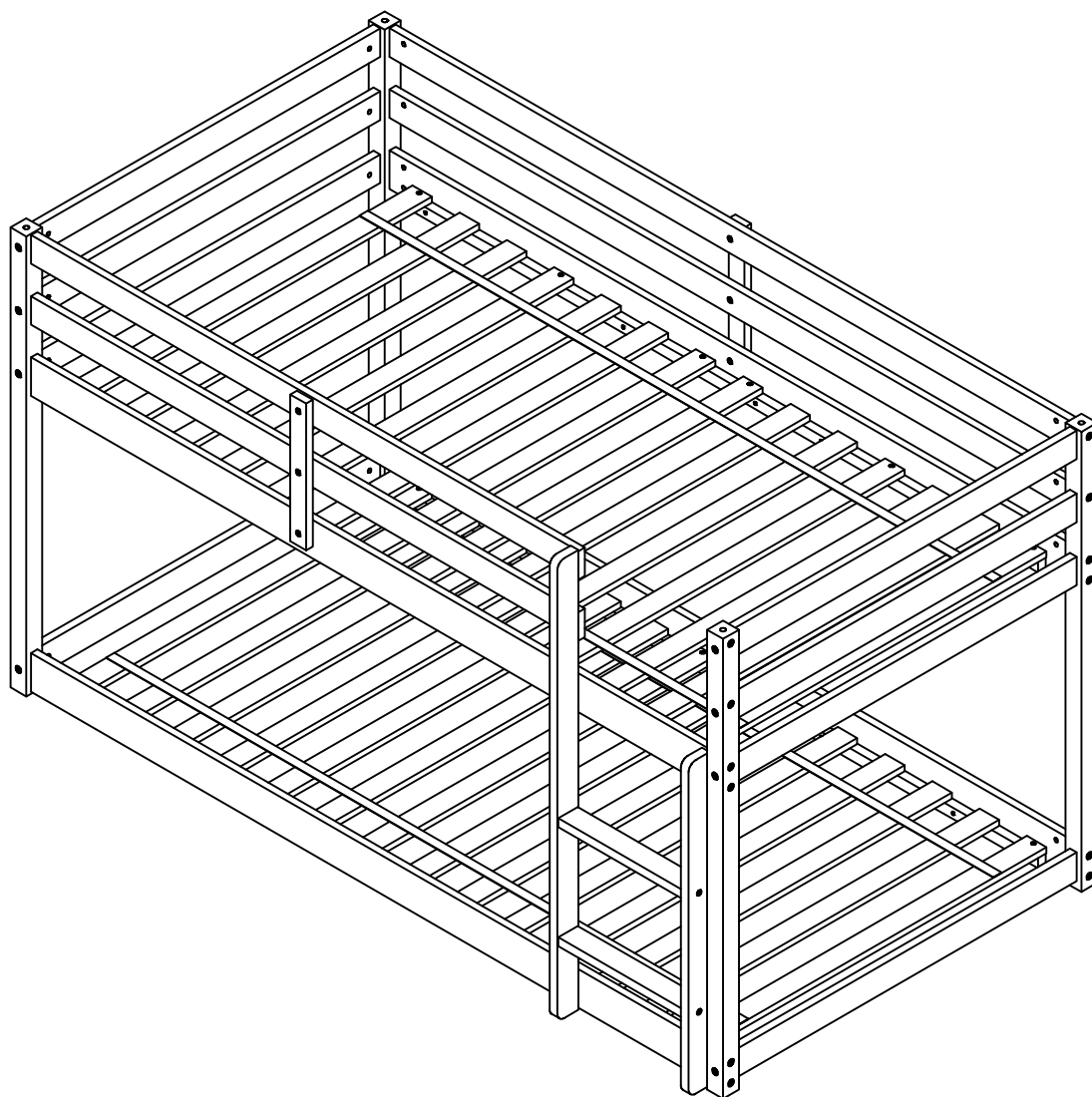

**DN11721**



# SAFETY WARNING



1. This bed is designed for use only mattress (es) meeting the following specifications on the upper bunk, and lower bunk:

## Down bed

Bed type	Length	With	Thickness
Twin Standard	74"-75"	38 1/2"	8" max

## Up bed (Bunk bed and tribed included)



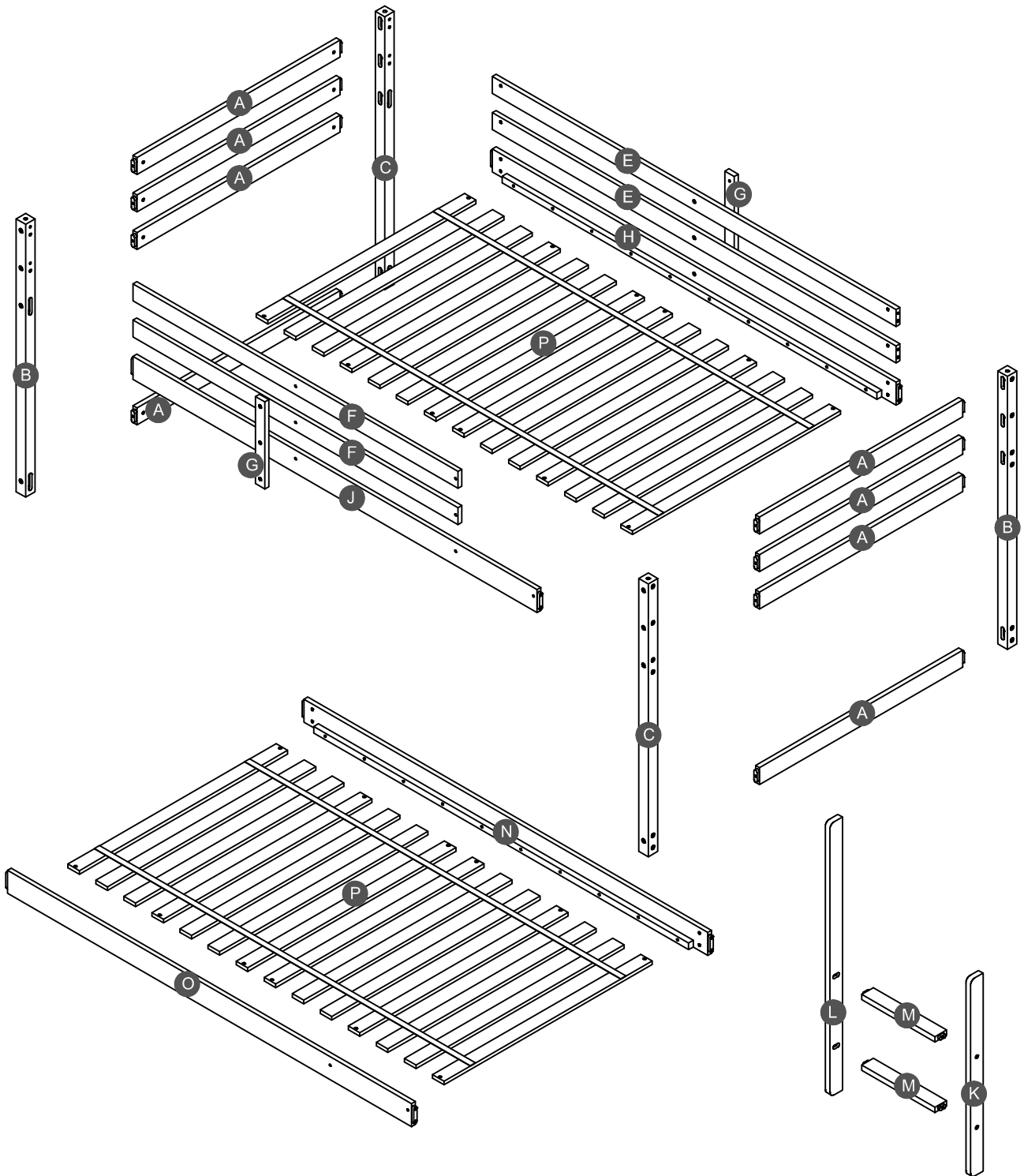

Bed type	Length	With	Thickness
Twin Standard	74"-75"	38 1/2"	6" max

2. Replacement parts, including additional guardrails, maybe obtained from any of our FREIGHTMAN EC CO.,LTD.
3. Follow the information on the warnings appearing on the upper bunk bed end structure and on the carton. Do not remove warning label from bed.
4. Always use the recommended size mattresses or mattress supports, or both, to help prevent the likelihood of entrapment or falls.
5. Surface of mattress must be at least 5" (127mm) below the upper edge of guardrails.
6. Do not allow children under 6 years of age to use the upper bunk.
7. Periodically check and ensure that the guardrail, ladder, and other components are in their proper position, free from damage, and that all connectors are tight.
8. Do not allow horseplay on or under the bed and prohibit jumping on the bed.
9. Always use the ladder for entering and leaving the upper bunk.
10. Do not use substitute part. Contact the manufacture or dealer for replacement part.
11. Use of a night light may provide added safety precaution for a child using the upper bunk.
12. Always use guardrails on both long sides of the upper bunk. If the bunk bed will be placed next to the wall, the guardrail that runs the full length of the bed should be placed against the wall to prevent entrapment between the bed and wall.
13. The use of water or sleep flotation mattresses is prohibited.
14. STRANGULATION HAZARD - Never attach or hang items to any part of the bunk bed that are not designed for use with the bed; for example, but not limited to, hook, belts and jump ropes.
15. Keep these instruction for future reference.



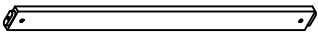
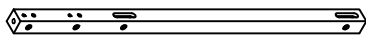
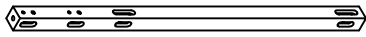
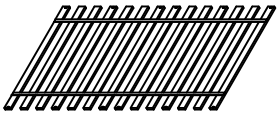
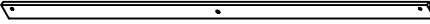
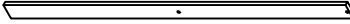

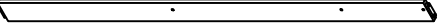
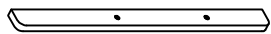
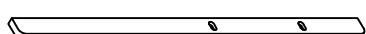

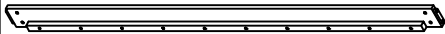
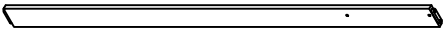
# Detail View

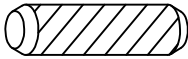

# Part List

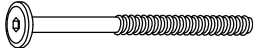
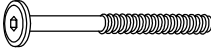
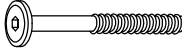
<b>A</b>  Horizontal bar HB/FB - 8pcs	<b>B</b>  Leg (Left Front /Right Back)- 2pcs	<b>C</b>  Leg (Left Back/Right Front)- 2pcs
<b>D</b>  Slats - 2sets (14pcs/set)	<b>E</b>  Long guard rail (Back) - 2pcs	<b>F</b>  Short guard rail (Front) - 2pcs
<b>G</b>  Vertical guard rail - 2pcs	<b>H</b>  Upper side rail (Back)- 1pc	<b>J</b>  Upper side rail (Front)- 1pc
<b>K</b>  Right side ladder - 1pc	<b>L</b>  Left side ladder - 1pc	<b>M</b>  Step ladder - 2pcs
<b>N</b>  Lower side rail (Back)- 1pc	<b>O</b>  Lower side rail (Front)- 1pc	

# Hardware List

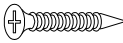
<b>1</b>  Ø10*40mm Wood dowel (6pcs)	<b>2</b>  (1/4")4.5*58mm Allen key (1pc)	<b>3</b>  (Ø15)1/4"*100mm Hex-Head bolts (22pcs)
<b>4</b>  (Ø15)1/4"*80mm Hex-Head bolts (16pcs)	<b>5</b>  (Ø12)1/4"*60mm Hex-Head bolts (4pcs)	<b>6</b>  (Ø12)1/4"*30mm Hex-Head bolts (6pcs)
<b>7</b>  1/4"*15 (9.5mm) Horizontal-Hole bolts(42pcs)	<b>8</b>  (Ø12)1/4"*40mm Hex-Head bolts (6pcs)	<b>9</b>  Ø4*30mm Wood screws (24pcs)

## ASSEMBLY TOOLS REQUIRED ( NOT INCLUDED )

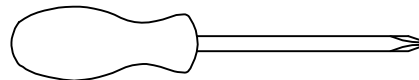

PLEASE BE CAREFUL DO NOT DAMAGE THE HOLE POSITION WHEN YOU USE POWER TOOLS !

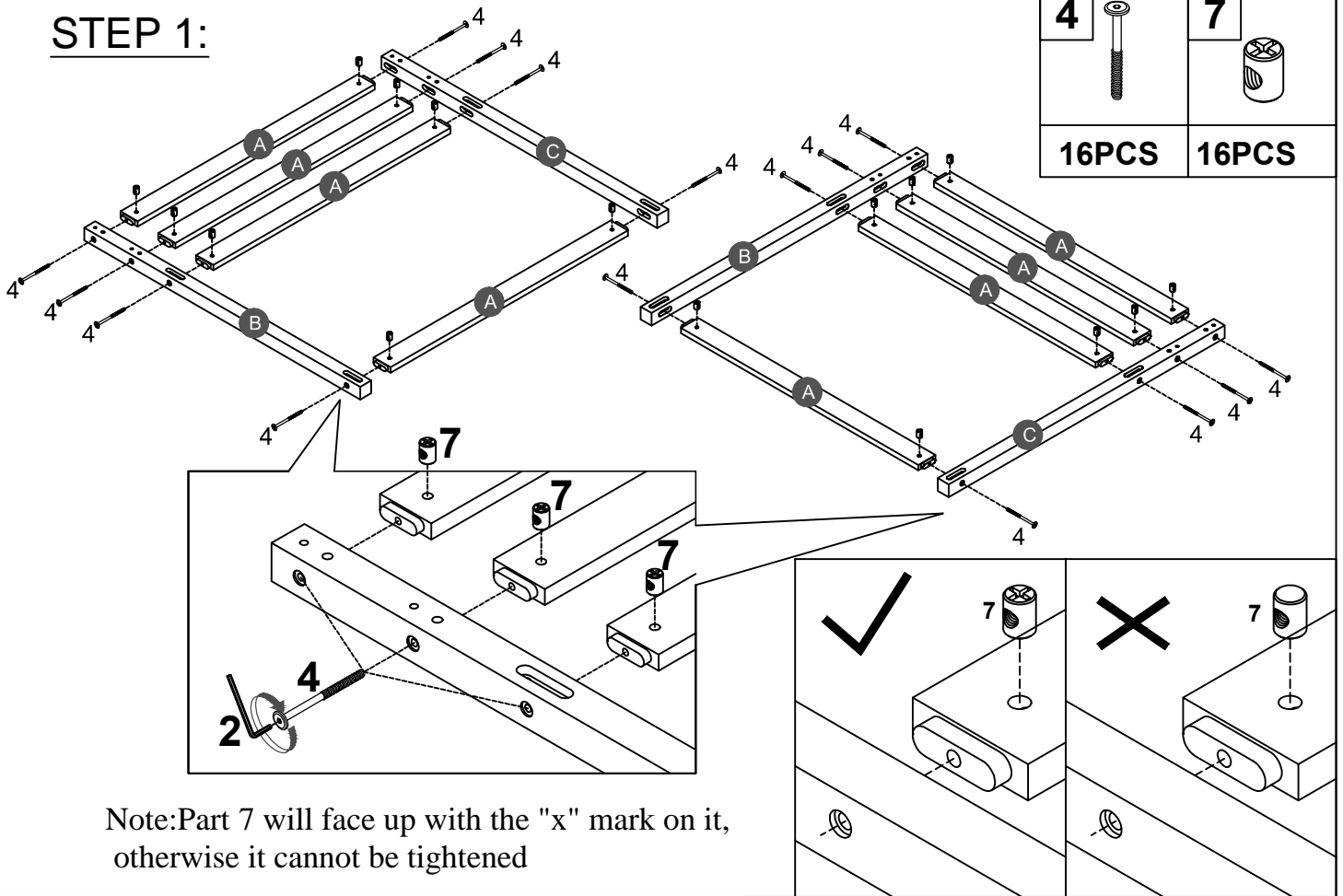

# STEP 1:

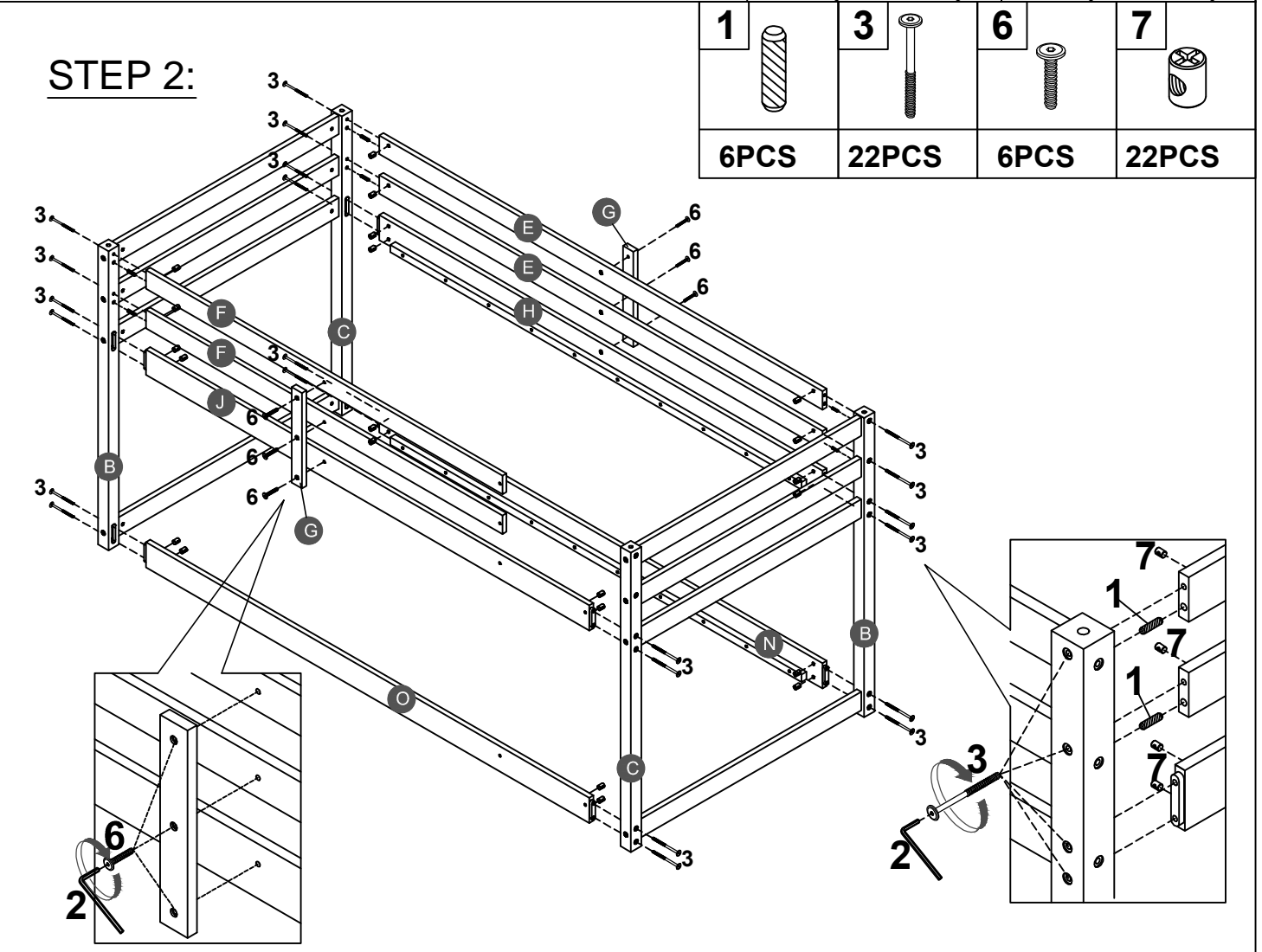

# STEP 2:



**STEP 3:**

<b>5</b>		<b>7</b>	
<b>4PCS</b>		<b>4PCS</b>	

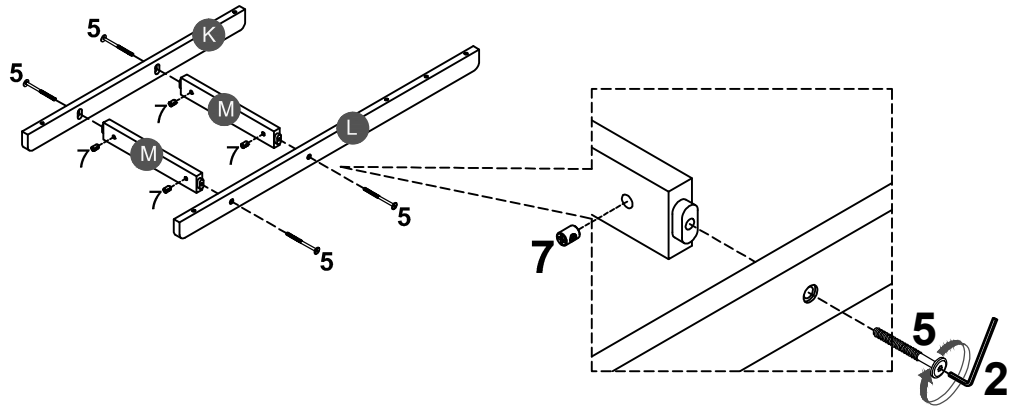

**STEP 4:**

<b>8</b>	
<b>6PCS</b>	

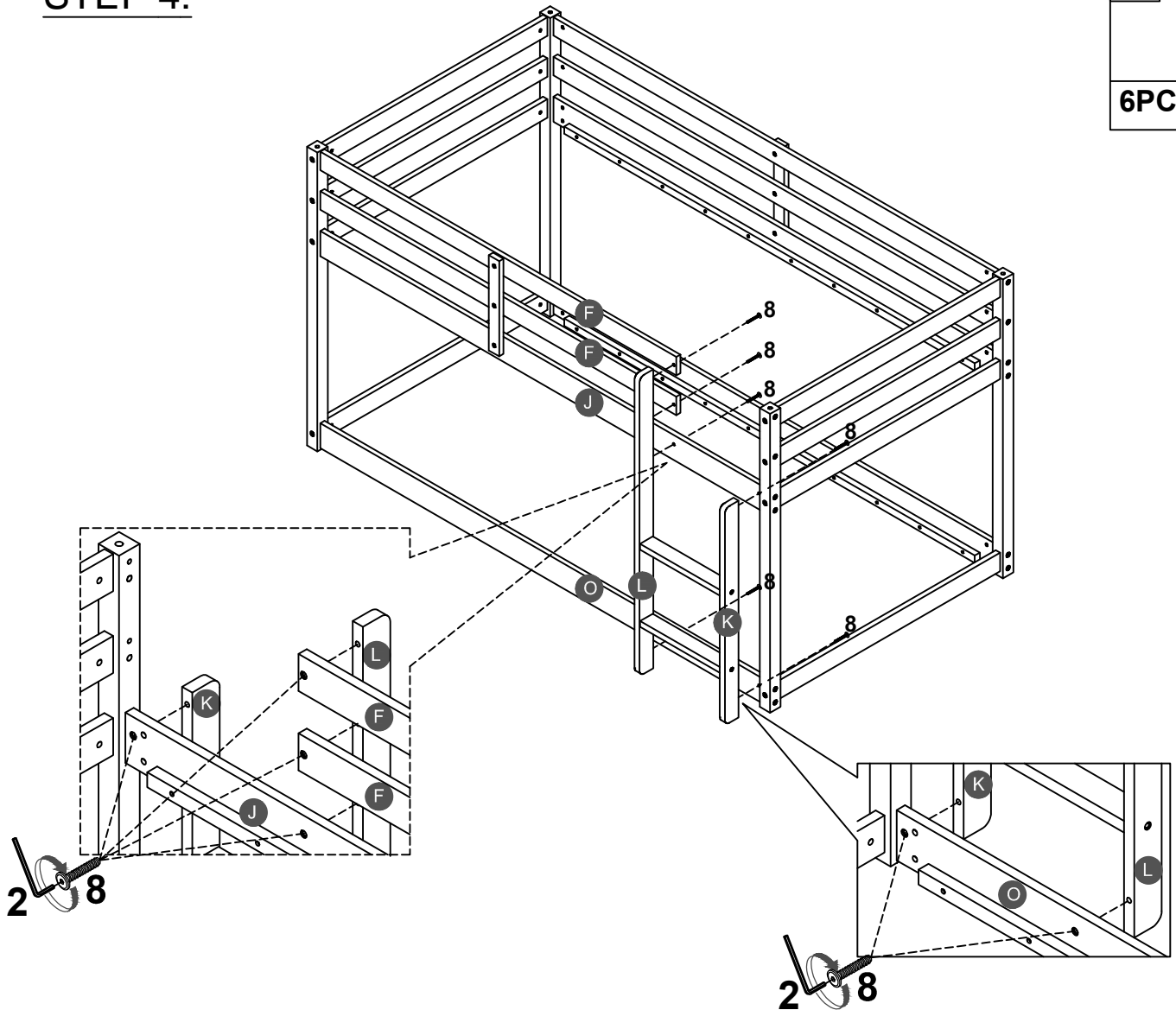

# STEP 5:

9



24PCS

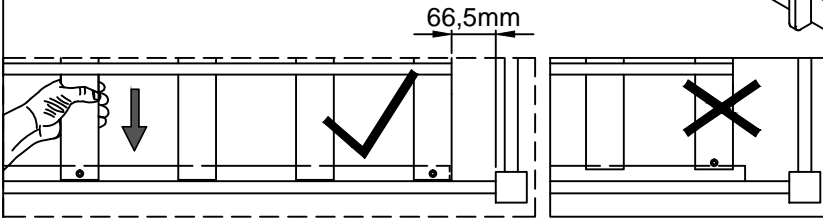
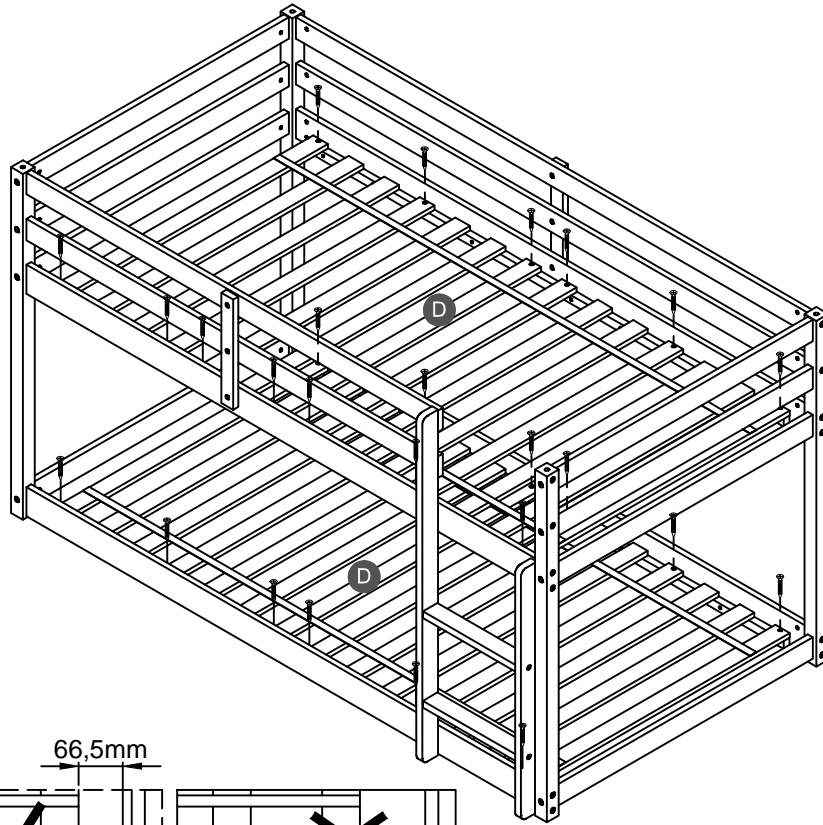
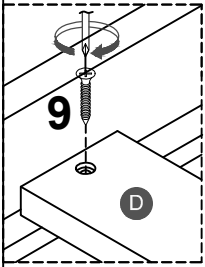

Note: Do not lock the screws of the bed slats to the outermost edge of the bed slats, you need to leave a certain space at the edges, otherwise it will cause the board to break. Do not lock the bed slats on the edge of the wood, please hold firmly before screwing, hold it in place with one hand, then lock the screw.

