



Classic/Select Series Patio Door Installation Instructions

RECOMMENDED TOOLS & ACCESSORIES

(Not supplied by Ply Gem)

- Phillips Head Screwdriver
- Flat Head Screwdriver
- Level (3' or longer)
- Framing Square
- Hammer or Stapler (See Fastener Schedule)
- Utility Knife
- Shims
- Sealant (Exterior Grade Sealant Required)
- Self Adhering Flashing Tape
- Fasteners (See Fastener Schedule)



IMPORTANT! READ ALL INSTRUCTIONS BEFORE BEGINNING INSTALLATION .

This door unit has been engineered and manufactured to provide superior weather protection and service.

The manufacturer warrants this product only when installed according to these instructions. The manufacturer will accept no responsibility for air or water leakage above, under, or around the door unit.

Do not paint any part of this unit for any reason. Painting will render null and void all warranties.

GENERAL CONDITIONS

IMPROPER INSTALLATION OR USE MAY VOID WARRANTY. MANUFACTURER ASSUMES NO RESPONSIBILITY FOR FAILURE OR INJURY FROM IMPROPER INSTALLATION, CARE, OR USE IN APPLICATIONS THAT EXCEED PRODUCT RATING.

- Store in dry, shaded area, and do not lay flat. Lean/stack no more than 6 units of the same size against one another as this may cause damage to the units and or structure. (Like sized units only, should be stacked against one another.)
- When handling doors, always lift at jambs for safety and prevention of component damage.
- Protect vinyl and glass from plaster, mortar, concrete, and paint. Remove such materials before they dry by

washing with clean water.

- DO NOT BLOCK WEEP HOLES.
- Avoid use of tools that could scratch glass or vinyl.
- Do not clean glass or vinyl with solvents, or cleaning fluids containing petroleum products, concentrated acids, or corrosive materials. These products can damage insulating glass seals and vinyl.
- **WARNING! Insect screens are for insect control only, and are not intended to provide a safety or security barrier.**









IT IS THE RESPONSIBILITY OF THE OWNER, ARCHITECT, OR BUILDER/INSTALLER TO SELECT AND INSTALL PRODUCTS IN COMPLIANCE WITH APPLICABLE LAW AND BUILDING CODES.

Classic/Select Series Patio Door Parts List

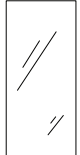
Account for all the following parts in the list below. These are parts that will be installed/attached to the door by the consumer during installation and will be shipped with the door separately (either taped or temporarily attached to the door). If a part is not accounted for, that is listed below, please contact your dealer for assistance barrier.

PICTURE	PART DESCRIPTION	CLASSIC QTY	SELECT QTY	REPLACEMENT PART # (if missing)
	OXXO Main Frame	0	1	N/A
	Active Panel	both	both	N/A

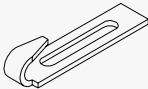
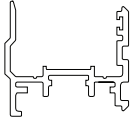
Classic/Select Series Patio Door Parts List (continued)

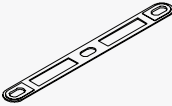
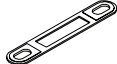
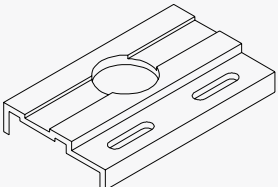
PICTURE	PART DESCRIPTION	CLASSIC QTY	SELECT QTY	REPLACEMENT PART # (if missing)
	Passive Panel	0	1	N/A
	Insulated Glass Units	0	2	N/A
	Glazing Bead - Short Pieces	N/A	SELECT only	N/A
	Glazing Bead - Long Pieces	both	both	N/A
	Screens	1	2	N/A
	Screen Astragal	2	1	57381206 (Standard Screen) 57380906 (Heavy-duty Screen)
	Screen Strike (in screen packet)	1	1	N/A
	OXXO Astragal (taped to Passive Panel)	0	1	N/A
	Interlock Cap (snapped onto OXXO astragal)	0	1	N/A
	1/2" Wheel Adjustment Hole Plugs	2	4	55453503 White 55453502 Almond or Tan
	Center Strike Shim	1	1	55733100
	Four-point Lock Strike Shim	0	2	55733200
	Shoot Bolt Strike	0	2	24387303 White 24387302 Almond or Tan

Recommended Installation Practices and Assembly Instructions

1. Inspect the rough opening. Confirm that the rough opening is clean, square, plumb, level and the dimensional size will accommodate the door. (Measure RO width at the bottom, middle & top and height at each side and in the middle.)
2. Apply at least two (2) continuous 3/8" wide bead of exterior grade sealant designed for door and window installation on the sub-floor the entire width of the rough opening at the sill in a consistent straight line. Sealant should be compatible with the vinyl door and the material of the sub-floor. Apply a 3/8" wide minimum bead of exterior grade sealant around the perimeter of the door where the installation fasteners penetrate the nailing fin at the pre-punched nail holes.
3. Remove shipping blocks from sill of mainframe by unfastening screws in nail fin and prying blocks away from frame.
4. Center the door in the rough opening, pressing the nail fin firmly into the sealant on the perimeter. Temporarily secure by placing a fastener in one of the upper corners of the door through the hole in the nailing fin nearest the corner.
NOTE: Fasteners must be corrosion resistant long enough to penetrate the rough opening framing by a minimum of 1-1/2".
5. Level sill and plumb jambs utilizing shims as needed. Spaced approximately 24" apart. If shims are needed, use enough to support the weight of the fixed and operable panels without causing distortion in the sill, and be sure to shim under the interlock in the center if the sill is shimmed.
IMPORTANT: If a sill pan system is used, shim between the opening and the pan, NOT between the pan and the doorsill. To avoid water infiltration from under the sill, use sealant above and below shims.
6. Measure diagonally from each top corner to opposite bottom corners. Check that the measurements are equal to verify that the door is square. Adjust to square with shims as needed.
Shims must remain in place.
7. Fasten door frame head, sill and side jamb 8 to 14 inches apart using nail holes provided on nailing fin. While fastening the door, be sure that the frame at the head and jambs remain straight and do not bow. **NAIL THROUGH NAILING FIN AT PRE-PUNCHED HOLES ONLY.**
8. **For 4 panel door:** Cut tape and remove OXXO Astragal, which has been temporarily attached to the passive panel. Set aside for use later.
9. Glaze fixed panels following "Field Glazing Instructions".
10. Install sliding panel into the frame using a #2 or 3 point Phillips hand screw driver. Raise the panel by turning the face adjustment screws clockwise, until the panel cannot be raised further.
11. Close the active and passive panel leaving a small gap between them. Check the gap between the panels making sure the gap is equal at the head and sill. Adjust the wheels as needed until the gap is equal at the head and sill.
12. **For 4 panel door:** Using exterior grade sealant suitable for vinyl door and window applications, apply two (2) beads of sealant along edges of passive panel lead stile where OXXO Astragal will be attached. Push OXXO Astragal onto the lead stile of passive panel, strikes facing toward the exterior and interlock facing inside of the home. Ensure gap at head and sill of astragal is equal.

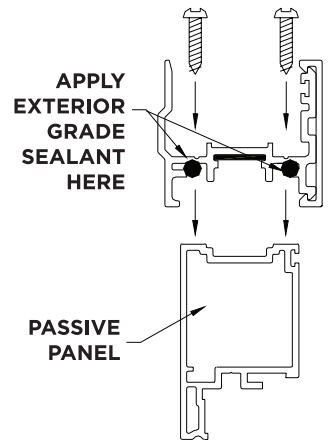

13. **For 4 panel door:** Using a square drive screwdriver, secure the OXXO Astragal to the passive panel using the square head screws provided every 8 to 12 inches in pairs utilizing the ID lines in the profile as a guide.
14. Install shoot bolt strike by engaging the bolt in the strike and closing the panel. Mark the main frame where the shoot bolt strike would be located, and **drill a 3/8" diameter hole through the shoot bolt strike bolt hole through the first vinyl wall only, in the head.** Secure the shoot bolt in the head of the main frame using two #8 x 3/4 Phillips Pan Head screws.
15. **For 4 panel door:** Check operation of multi-point lock hooks engagement in strikes. If adjustment is needed, loosen screws in the center strike and four-point lock strikes (found mounted to the OXXO Astragal) until strikes can move freely. **DO NOT REMOVE.** Adjust the vertical position of the strikes and ensure proper lock operation.
16. Install screen by turning adjustment screw counterclockwise to retract screen rollers into the screen frame in the sill. Insert top of screen into screen channel in the head. Lift into place on top

(continued next page)

Recommended Installation Practices and Assembly Instructions (continued)

of screen track. Turn adjustment screws clockwise. Adjust rollers in active and passive panel screens until the gap (when screens are pulled together) at the head and sill are the same.

17. **For 4 panel door:** Attach screen astragal to passive screen by pushing the astragal onto the screen frame, with the curved pieces facing the groove in the passive screen frame. Adjust vertically until the gap at the head and the sill between the screen astragal and the door frame are equal.
18. **For 4 panel door:** Attach screen strike onto Screen Astragal with screws provided. Adjust as needed check operability.
19. Nailing fins **MAY NOT** provide adequate flashing. (**Recommended**) Flashing by others should be applied as per the flashing manufacturers specifications to the wall materials. Wall materials should be flashed and sealed to the window frame, over the nailing fin, to provide a weather-resistant seal. Flashing should create a shingle effect application at all overlaps. Please refer to the flashing manufacturers specifications.
20. Insulate between door and rough opening. Fiberglass insulation packed loosely into place. Low Expanding foam insulation may be used per that product manufacturers specifications and instructions provided it does not cause issues by deforming the door or other operational issues.
21. Follow siding and/or trim manufacturers specifications for maintaining gaps at all intersecting junctures. If instructions are not available, and as a minimum, maintain a minimum a 1/8" or 1/4" gap between siding or trim and vinyl frame to allow for expansion. Fill gap with flexible exterior grade sealant.
22. Exterior wall systems, such as stucco and EIFS, must be designed and installed to manage moisture around all through wall penetrations. Follow wall finish manufacturers recommendations.

Maintenance

Sill roller track and weep holes must be cleared of construction debris following installation and periodically thereafter to prevent damage to rollers and to allow drainage.

- Use only warm water and mild detergent with a clean cloth to clean glass or vinyl. Rinse with clean water and squeegee glass dry.
- Avoid use of razor blades, sharp tools, or dirty cloth, which may scratch glass. Do not use acids, alkalis, or concentrated solutions of vinegar or ammonia, which can damage glass seals.
- Internal lock parts and door rollers should be lubricated once a year with a graphite or Teflon lubricant to maintain smooth operation.
- Maintenance and replacement parts may be ordered through your dealer



ANY ALTERATIONS OF THE PRODUCT NOT AUTHORIZED IN ADVANCE BY THE MANUFACTURER WILL VOID WARRANTY.



WARNING This product can expose you to chemicals, including Titanium Dioxide, which are known in the State of California to cause cancer, birth defects or other reproductive harm. For more information go to www.P65warnings.ca.gov

Classic/Select Series Patio Door Installation Instructions

Preparing the Opening

Before installation, be sure that you thoroughly read sections 1 and 2 of these installation instruction guidelines and that the rough opening has been correctly prepared.

- Clean all debris from around the edges of the rough opening.
- Apply a bead of high-performance exterior grade sealant around the perimeter of the door nailing fin in line with the pre punched holes.
- If the door frame needs to be taken out and re-installed, remove the exterior grade sealant and re-apply before the door is installed again to ensure an air- and water-tight installation. Refer to the section regarding sealants for additional information.

Typical Concrete Masonry Application

When applying a door in concrete masonry, head and jambs should be framed with a suitable wood framing material. The sill should be framed with framing materials specifically designed for direct contact with masonry products (check local building codes).

Note: When adding appropriate framing material to a concrete masonry opening, make sure that the rough opening into which the door will be installed will be the correct size after the appropriate framing is installed.

1. Place two continuous beads of masonry adhesive sealant along the concrete rough opening at the head, jambs and threshold (figure 2). Use a nominal 3/8" bead of masonry adhesive sealant to apply 2 continuous straight lines across the entire area where the appropriate framing member will be installed.
2. Place the appropriate dimensional framing at the entire length of the head, jambs and sill. Be sure that the adhesive sealant is completely compressed ensuring the framing material is embedded into the adhesive between the concrete. Fasten the framing to the concrete.

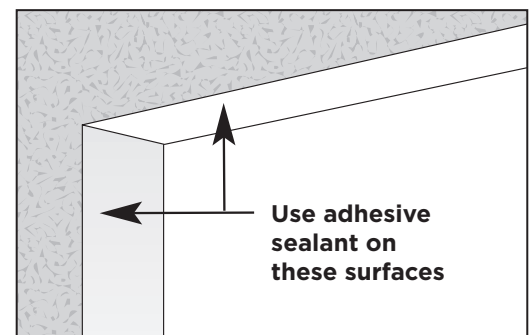

Figure 2

Note: The appropriate framing material for direct contact or embedment with concrete at the sill may be imbedded into the concrete floor so that the top will be flush with the concrete floor (figure 3). This will keep the door from possibly sitting up too high in the opening.

IMPORTANT: Use the proper type and number of fasteners when attaching the framing for concrete. Refer to local building codes for acceptable application of fasteners and suitable framing material for direct contact with concrete and/or masonry products.

For applications in which only the floor is concrete and not the wall, only the sill must be sealed and a suitable framing member approved for direct contact and/or embedment into concrete is put in place.

3. Seal the joints between the framing members at the corners.
4. Apply a continuous 3/8" bead of high performance exterior grade sealant around the interior side of the nailing fin in line with the fastener holes.

Important: After installation of your new Patio Door, the exterior side of the rough opening, framing members and nail fin joint should be covered with flashing, and trimmed so as to cover the gap between the framing and the concrete walls (figure 3). Care should be taken to prevent the entrapment of water in these areas.

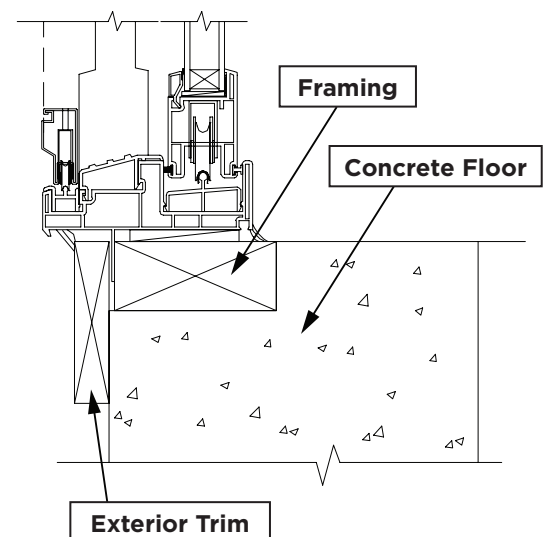

Figure 3

Installing the Door Frame

Before installation, be sure the operable panel and screen are removed from the door frame. To remove the operating panel, open and slide the panel to the fully open position. Adjust door rollers down as far as possible. Lift the panel toward the frame head until the bottom of the panel clears the frame threshold track. Swing the bottom of the panel toward you and slide the top down and then out of the door frame (figure 4).

1. Using the correct number of helpers or the appropriate equipment, lift and place the door into the rough opening.
2. Place the door threshold on the shims located on the subfloor. Center and tip the frame into the rough opening.
3. Press the frame firmly into the sealant and fasten one of the upper corners.
4. Check the threshold for level and shim as necessary. If shims are needed at the sub-floor, use enough to support the weight of the fixed and operable panel without causing distortion in the threshold.



IMPORTANT: If a sill pan system is used, shim between the opening and the pan, not between the pan and the door threshold. To avoid water infiltration from under the sill, use sealant above and below the shims.

5. Check the frame for plumb and the jambs for straightness, shimming as necessary.
6. Take diagonal measurements to ensure the door frame is square. Shim as required.
7. Securely fasten the door frame to the rough framing through the center of the slots in the nail fin (figure 5). Place fasteners in the slots closest to each corner and every other slotted nail hole as a minimum, (**please check local codes for minimum on center spacing of fasteners**).
8. Remove the #8 x 1/2" screws from the lock keeper and replace them with #8 x 2-1/2" screws that are provided with the door (figure 6). These screws will penetrate the door jamb and will secure into the wood frame of the home. To ensure the proper support of the jamb and the strike, shimming the full length of the lock strike must be placed between the door jamb and wood rough opening framing before tightening the fasteners. This additional shimming at the door strike location is critical also, please do not over tighten the door strike screws as this may deform the door frame preventing the operating panel from fully closing.

Proper installation is required to ensure smooth door operation. Check general operation and locking prior to the installation of exterior and interior trim.



IMPORTANT: The manufacturer assumes no responsibility for the consequences of inadequate or improper installation or lack of care of the installed product.

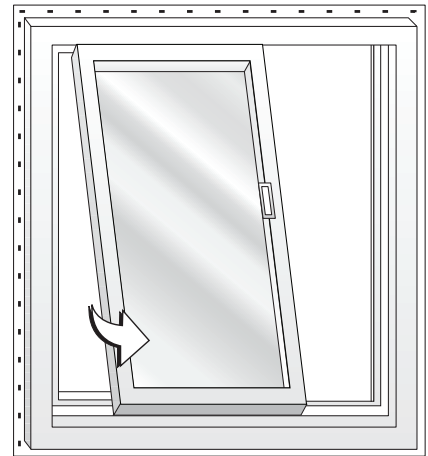

Figure 4

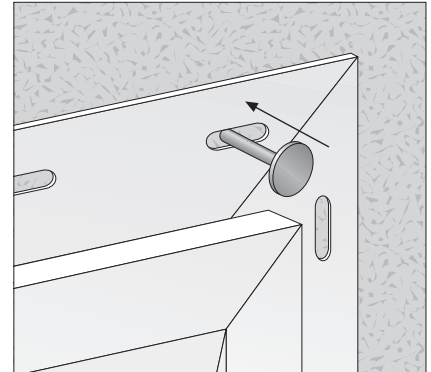

Figure 5

#8 x 2-1/2" Phillips Pan Head Screws



Figure 6

Lock Strike

Installing Panel to Frame

1. Insert the operable panel into the head track where it would be in the fully opened position (the same side as the fixed panel). Rotate the sill end of the panel over the frame sill and lower it into the roller track (figure 7). Make sure the panel rollers are properly seated on the roller track.
2. Slide the panel all the way toward the closed position until it meets the edge of the door frame jamb. Check the reveal between the panel and frame to be sure the gap is even along the entire vertical edge of the panel (figure 8).
3. If the reveal is uneven, use the roller adjustment screws in the two holes located on the interior side of the operating panel bottom rail (figure 9) to adjust the panel. Start with the door panel all the way down and work upward. Adjust the rollers so that the panel penetrates the sill track by $\frac{3}{8}$ " on both ends. To raise the rollers, turn the adjustment screws clockwise; to lower the rollers, turn them counterclockwise. Proper adjustment of the rollers will ensure smooth operation of the panel.



IMPORTANT: Raising the operating panel too high may cause interference with the anti-lift blocks placed in the head of the panel track.

4. Re-check the panel/frame jamb reveal. Continue making adjustments in the rollers until the panel is correctly positioned in the frame. Slide the panel to check that it operates smoothly.
5. Place adjustment hole covers, provided with the door, into the wheel adjustment screw holes

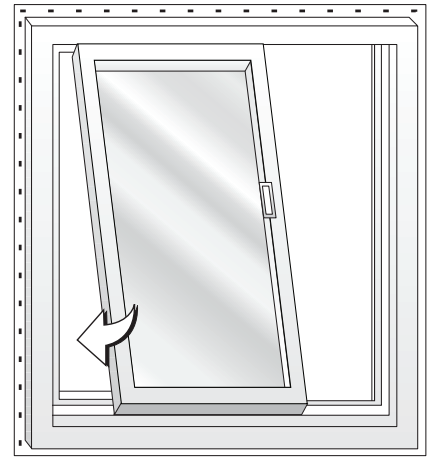

Figure 7

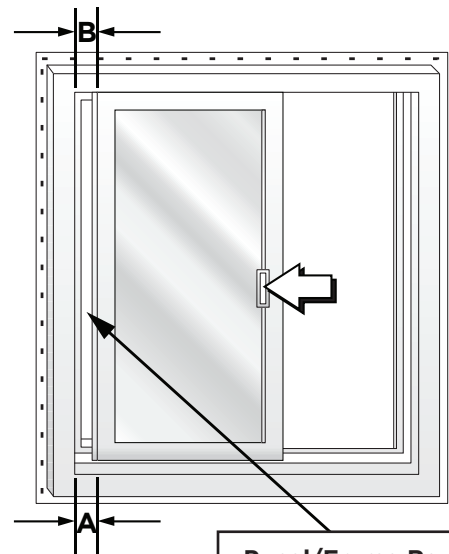

Figure 8

**Panel/Frame Reveal
(A must equal B)**

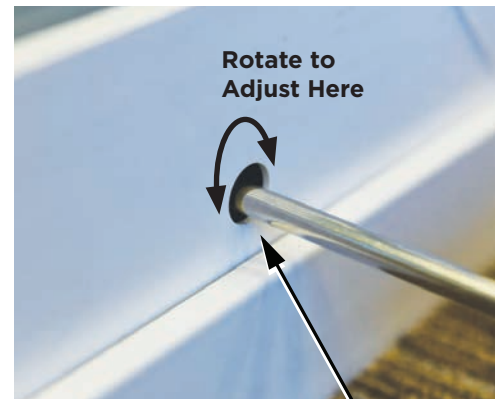
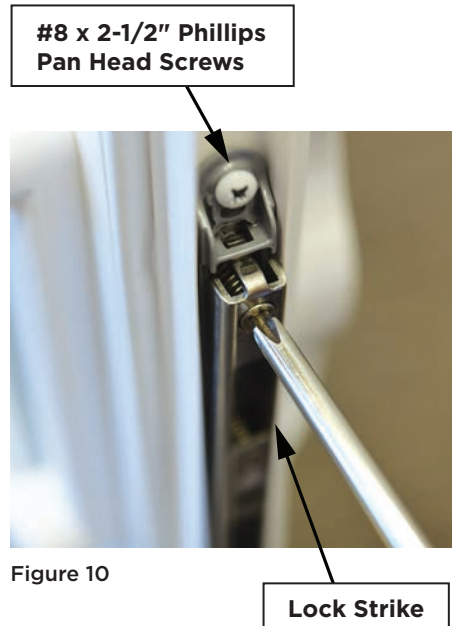

Figure 9

**Wheel Adjustment
Screw Hole**

Adjusting the Lock

1. Place the locking lever up to the unlock position. Close the operable panel until it contacts the lock strike. If the hooks on the locking mechanism are not aligned with the slots in the strike, the strike must be adjusted up or down to allow the hooks to engage the slots in the strike (figure 10).
2. Untighten the two screws on the lock strike to align the strike with the hooks on the lock. The slotted screw holes of the strike will allow limited movement up or down. Re-tighten the screws in the strike after the lock hooks and strike are aligned.
3. If the lock hooks and strike do not align at this point, then the operator panel rollers must be adjusted up or down accordingly (refer to step 3, installing the panel). Remember, the panel must remain square with the frame and the reveal even during and after this process.
4. Check to ensure lock hook engagement is smooth and secure. Follow instructions on the door to adjust the lock hook engagement which may be on the lock or strike. A properly adjusted lock should operate smoothly/freely and allow limited panel movement when locked.



Sealing and Trimming

The sealing and trimming of process for a patio door is consistent with the sealing and trimming of general window installation.

Installing the Screen

1. Turn the adjusting screws at both ends of the top and bottom rails (figure 11). Turning counterclockwise will depress the rollers into the screen frame. Adjust the screws until all of the rollers are completely depressed into the screen frame (figure 12).
2. Place the top of the screen frame into the head of the screen track. Lift the bottom rollers onto the sill screen track by using a thin screwdriver as a lever.
3. Turn the bottom roller adjustment screws to align the screen with the frame jamb creating an even reveal, and engage the screen into the frame head. Turn the screws clockwise to raise the screen.
4. Turn the top roller adjustment screws to the desired roller tension for easy screen operation. Turn the screws clockwise to increase tension.
5. Close the screen frame until it contacts the keeper at the jamb. If the lock hook on the screen locking assembly does not align with the keeper, adjust the keeper by untightening the two fastening screws and moving the keeper up or down along the slots until the hook is aligned properly.
6. If the lock hook and keeper do not align at this point, then the screen rollers must be adjusted up or down accordingly. Remember, the screen must remain square with the frame and the reveal even during and after this process.

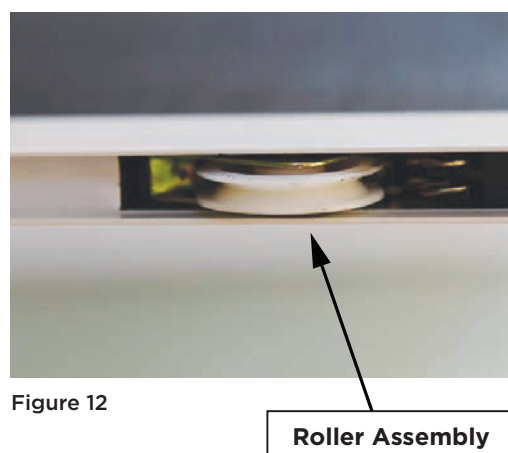
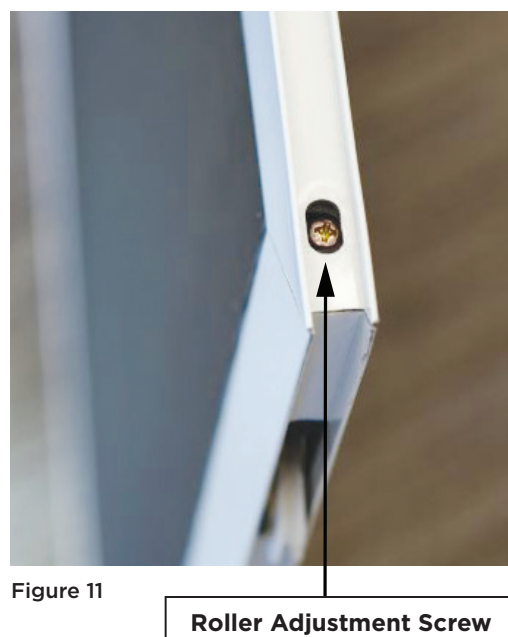

Patio Door Operation

1. To operate the interior locking mechanism of the patio door, place the locking lever behind the interior handle pull in the up position to unlock (figure 13).
2. Pull the handle away from the jamb to open the door panel.
3. Press the handle toward the jamb to close the panel.
4. To operate the interior locking mechanism of the patio door, place the lever behind the interior handle pull in the down position to lock. Make sure that the door panel is pressed securely into the jamb so that the lock hooks make proper contact with the strike.

Maintenance

Lubrication

To help prolong the life of the patio door and maintain ease of operation, the internal moving parts of the lock and rollers should be lubricated with a graphite or Teflon lubricant once a year.



CAUTION: Do not use silicone-based products to lubricate as they may discolor the PVC.

Cleaning

For regular glass cleaning, a common window cleaner with a lint-free cloth or chamois should be used.

For frame and door cleaning, a common window cleaner or mild detergent solution with a regular cloth should be used. After cleaning be sure to thoroughly rinse all PVC surfaces with clean water to remove any detergent residue.

Be sure that the threshold, roller track and panel rollers are kept clean and free of debris.

IMPORTANT: These precautions must be followed:

1. **Do not use caustic or abrasive cleaners or any silicone-based solvents on the PVC frame or sash surfaces as they may damage or discolor the PVC.**
2. **Do not use petroleum-based lubricants on the patio door as they may discolor the PVC.**
3. **Do not use insecticides (bug spray) on or near the patio door. Contact of insecticides with the PVC will damage or discolor the door surface.**

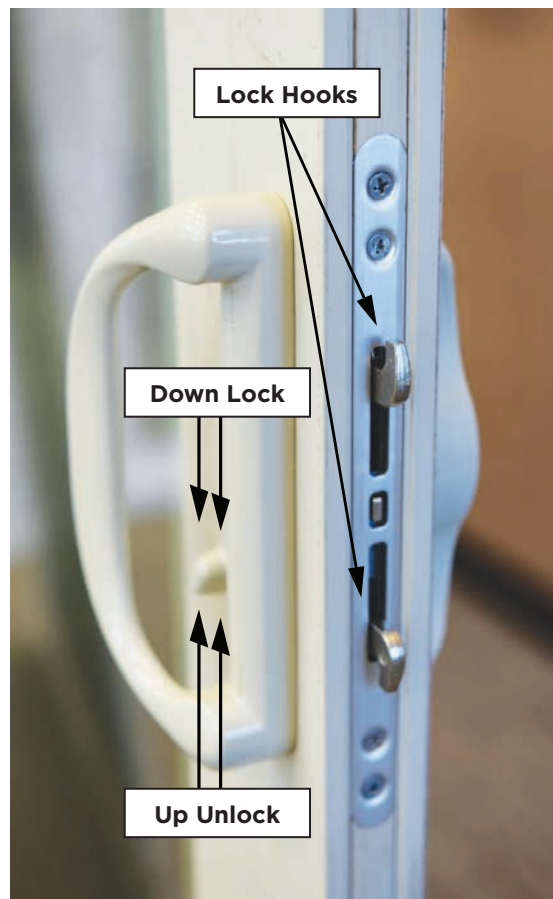

Figure 13



Patio Door Field Glazing Instructions

RECOMMENDED TOOLS & ACCESSORIES

(Not supplied by Ply Gem)

- Tools and Materials You May Need
- Gloves
- Eye Protection
- Stiff Putty Knife
- Soft Faced Hammer
- Utility Knife
- Liquid Glass Cleaner
- Clean Soft Cloth



IMPORTANT! READ ALL INSTRUCTIONS BEFORE BEGINNING INSTALLATION .

This door unit has been engineered and manufactured to provide superior weather protection and service.

The manufacturer warrants this product only when installed according to these instructions. The manufacturer will accept no responsibility for air or water leakage above, under, or around the door unit.

Do not paint any part of this unit for any reason. Painting will render null and void all warranties.

GENERAL CONDITIONS

IMPROPER INSTALLATION OR USE MAY VOID WARRANTY. MANUFACTURER ASSUMES NO RESPONSIBILITY FOR FAILURE OR INJURY FROM IMPROPER INSTALLATION, CARE, OR USE IN APPLICATIONS THAT EXCEED PRODUCT RATING.

1. Once door is installed, sealed and secured to the structure it is now time to install the glass in the frame.
2. **PLEASE, read the instructions all the way through!**

3. The glazing bead used for mechanically securing the glass in the fixed openings had been attached and shipped with your new door. It should be positioned within close reach of the fixed glass area you are currently working with.



IT IS THE RESPONSIBILITY OF THE OWNER, ARCHITECT, OR BUILDER/INSTALLER TO SELECT AND INSTALL PRODUCTS IN COMPLIANCE WITH APPLICABLE LAW AND BUILDING CODES.

Recommended Patio Door Field Glazing Instructions

Step 1. Preparing to Set the Door Glass.

The glass is installed from the exterior of the door. Using cardboard or other similar material as a cushion, place the cardboard on the ground close to the area where you will be installing the glass. Next, locate the glass you will be using and, utilizing adequate assistance carefully place the glass being used, next to where it is being installed. The labels attached to the glass should be oriented so that when the glass is installed, they are on the interior surface of the glass inside the home. Using a liquid glass cleaner and clean cloth, clean the glass around the entire perimeter for at least 2" in from all edges to ensure adhesion and there is no debris lodged in the rim spacer between the edges particularly at the bottom.

Step 2. Preparing the Glazing Tape.

Beginning at the upper corner of the door frame, carefully peel back the glazing tape backing material, exposing the adhesive until approximately 4" of the glazing tape is exposed. Repeat for each corner (both vertically and horizontally), until all 4 corners are done. See Figure 1
Next, fold the glazing tape backing material over so it may be accessed from inside the door.



Figure 1

(Patio Door Field Glazing Instructions continued next page)

Recommended Patio Door Field Glazing Instructions (continued)

Step 3 Applying Glass Setting Blocks.

Position the setting blocks across the bottom rail of the door for the glass to sit on and cushion it off of the door panel frame. These setting blocks should be within 2" of the corners and approximately every 6" on center across the bottom rail of the door panel. Note: DO NOT cover weep holes in the door panel, simply move the setting blocks to one side of the weep hole. See Figure 2

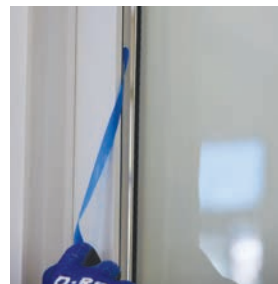

Figure 2

Step 4 Setting the Insulated Glass Unit.

Using adequate assistance, orient the glass so that the labels are located on the interior side of the door. Next, lift the insulated glass panel into the opening, bottom first until it is resting on the setting blocks located on the bottom rail of the panel.

Before raising the insulated glass panel into place, check to see if the glass has equal clearances on both sides, to prevent binding. If not, adjust as needed. See Figure 3



Figure 3

⚠ Caution: Do not let the insulated glass touch the glazing tape until it is positioned in the cent of the opening.

Step 5 Final Positioning of the Glass

With the insulated glass unit centered in the opening, carefully guide the glass into the opening so that it contacts the glazing tape. **STOP! Before going any further, ensure that all ends of the glazing tape backing protrude to the inside of the home.**

Step 6 Remove Glazing Tape Backing.

With your assistant gently holding the glass in place from the exterior side, you must proceed inside the home, carefully pull the glazing tape backing toward the opposite corner, being careful not to rip the backing material. You will have to do this on both stiles and the top and bottom rail. See Figure 4

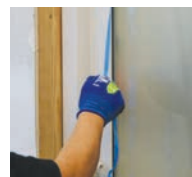

Figure 4

Step 7 Ensure Adhesion.

Once all backing material has been removed, have your assistant press the edges of the insulated glass unit into the tape to ensure a secure bond between the glass and the tape. See Figure 5



Figure 5

Step 8 Applying the supplied glazing bead.

Locate the longer two pieces of glazing bead and apply them first by starting at the corner. First: Insert the glazing bead leg into the glazing kerf.

Using your thumbs, press the glazing leg into the glazing kerf of the door panel. See Figure 6

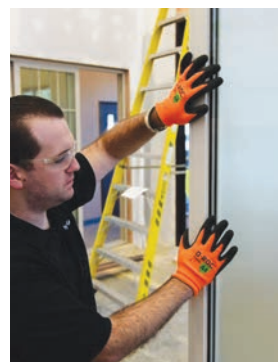

Figure 6

Where butt cuts (square end cuts), are located, make sure that the mitered end of the next glazing bead it comes into contact with overlays it, to create a visual mitered corner; sometimes this requires you to slide the glazing bead being applied behind the previously installed glazing bead. See Figure 7

You may occasionally need to trim the length of some of the glazing bead, this may be done with a utility knife.

Continue until all 4 sides have been installed and completed.



Figure 7