

Features

- Fits minimum 33-inch apron sink base cabinet.
- Single bowl.
- 9-inch depth.
- Self-Trimming apron overlaps the cabinet face for easy installation and beautiful results.
- No faucet holes.
- Basin slopes 2 degrees toward drain to minimize water pooling.
- Offset drain increases workspace in the sink and storage space underneath.
- Includes cutout templates.

Material

- KOHLER® enameled cast iron.

Installation

- Under-mount apron-front.

Recommended Accessories

- K-9000 P-Trap
- K-6377 Sponge Caddy
- K-6378 Kitchen Brush Caddy
- K-6379 Kitchen Squeegee
- K-6382 Disinfecting Wipes Dispenser
- K-6383 Soap Dispenser
- K-8618 Paper Towel Holder
- K-8619 Flexible Kitchen Mat
- K-8624 Dish Scraper

Optional Accessories

- K-6449 Sink Rack
- K-8801 Sink Strainer

Components

Additional included component/s: Countertop cutout template, and Cabinet face cutout template.



Codes/Standards

















ASME A112.19.1/CSA B45.2

KOHLER® Enameled Cast Iron Kitchen Sink Lifetime Limited Warranty

See website for detailed warranty information.

Available Color/Finishes

Color tiles intended for reference only.

Color	Code	Description
	0	White
	FF	Sea Salt™
	96	Biscuit
	47	Almond
	FD	Cane Sugar™
	NY	Dune
	95	Ice™ Grey
	G9	Sandbar
	33	Mexican Sand™
	K4	Cashmere
	FT	Basalt
	58	Thunder™ Grey
	20	Suede
	KA	Black 'n Tan
	FP	Caviar
	7	Black Black™

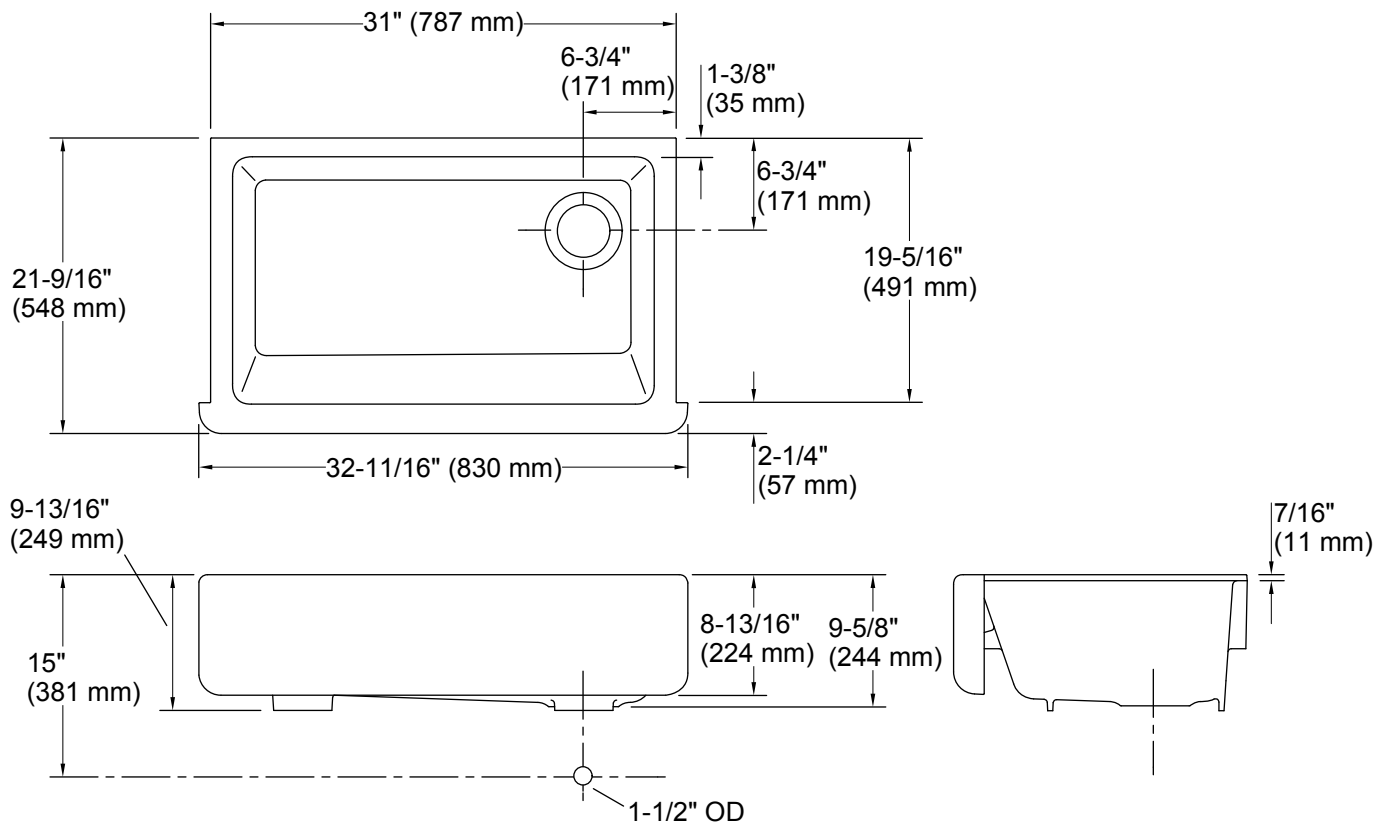

Technical Information

All product dimensions are nominal.

Bowl configuration:	Single
Installation:	Under-mount
Min. base cabinet width:	33" (838 mm)
Bowl area:	Length: 27-3/4" (705 mm) Width: 18-1/16" (459 mm) Bowl depth: 8-13/16" (224 mm) Water depth: 9" (229 mm)
Drain hole:	3-5/8" (92 mm)
Template:	1214395-7, not required, included 1217812, required, included

Notes

Install this product according to the installation instructions.

NOTICE: Countertop manufacturer or cutter must use the current product template available at www.kohler.com, or by calling 1-800-4KOHLER. Kohler Co. is not responsible for cutout errors when the incorrect cutout template is used.

IMPORTANT! The distance from the top edge of the cabinet to the top of the cabinet door must be at least 9" (229 mm) to install this sink.