

USE AND CARE GUIDE

VANITY TOP, BACKSPLASH

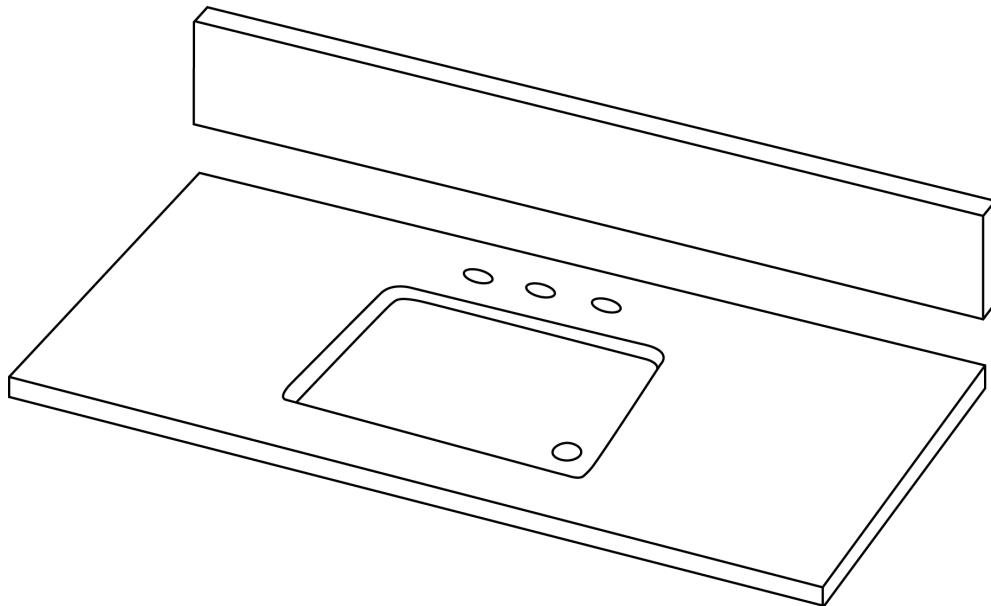

Questions, problems, missing parts? Before returning to the store,
call Home Decorators Collection Customer Service
8 a.m. – 7 p.m., EST, Monday – Friday, 9 a.m. – 6 p.m., EST, Saturday

1-800-998-7021

[HOMEDEPOT.COM/HOMEDECORATORS](https://www.homedepot.com/homedecorators)

Table of Contents

Table of Contents	2	Pre-Installation	3
Safety Information	2	Installation	3
Warranty	2	Care and Maintenance	4
Package Contents	3		

Safety Information

This instruction manual is for natural granite vanity tops, quartz vanity tops and engineered marble vanity tops. Please read and understand this entire manual before attempting to assemble, operate or install the product. If you have any questions regarding the product, warranty service or additional information, please call customer service at 1-800-998-7021, 8 a.m. - 7 p.m., EST, Monday - Friday. 9 a.m. - 6 p.m., EST, Saturday.

 **WARNING:** DO not disassemble and/or reassemble the vanity top without a professional installer.

 **CAUTION:** The vanity must be strong and standing firm to support the vanity top. The size of vanity must match with vanity top.

 **WARNING:** DO not use the vanity top before the adhesive is completely dry.

 **CAUTION:** Before installing backsplash, ensure the wall is dry, flat and clean.

 **WARNING:** To prevent possible injury, it is recommended two people install the vanity top to the vanity.

 **CAUTION:** To prevent possible injury, it is recommended two people install the vanity top to the vanity.

Warranty

The manufacturer provides a one-year limited warranty for residential use that the vanity top will be free from manufacturing defects, provided the original purchaser resides in or owns the home of installation, and provided the natural vanity top is installed and maintained according to the installation and maintenance instructions contained within and supplied by the manufacturer. The liability will be limited to cost of products only. This warranty is in lieu of any other express warranties. During the warranty period, the manufacturer, at its option, will repair or replace any part or product that proves to have substantial defects in materials or workmanship, or the manufacturer will provide an equivalent replacement product. This warranty does not cover any problems or damage which result from improper transportation, improper installation, mishandling, misuse, abuse, neglect, abnormal use, commercial use, improper maintenance, non-manufactured repairs, accidents. This warranty also does not cover labor charges for installation or removal of the product or any associated products.

Package Contents

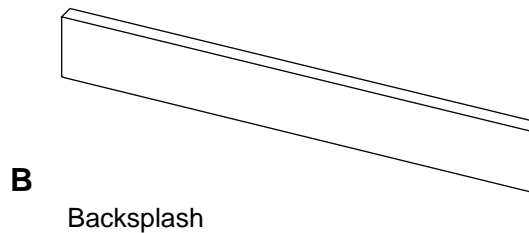
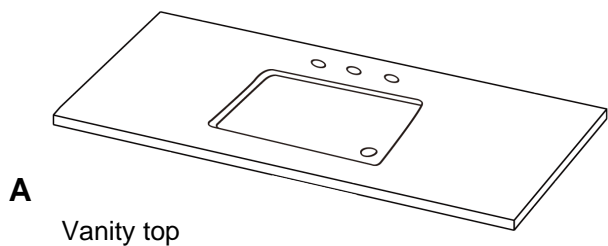

Pre-Installation

Products should be examined for defects prior to installation. Before beginning installation of product, make sure all parts are present. Compare parts with package contents list. If any part is missing or damaged, do not attempt to assemble, install or operate the product. Contact customer service for replacement parts.

Estimated Assembly Time: 60-90 minutes.

Tools Required for Assembly (not included): Caulking gun, caulk, silicone adhesive, level and putty knife.

Installation

1. Place silicone adhesive on the top edges of vanity (not included). Carefully set vanity top (A) on top of vanity.

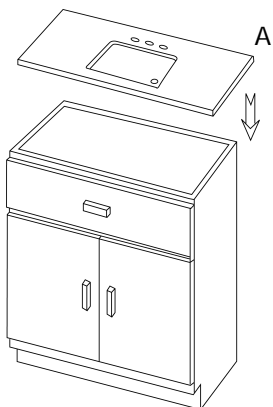

2. Apply adhesive to the back of backsplash (B), pushing firmly to secure backsplash (B) to the wall. Use caulk to close the gap between the vanity top (A) and backsplash (B). Once adhesive dries, install faucet and drain assemblies (not included) according to manufacturers' instructions.

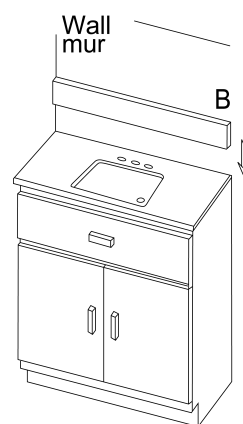

Care and Maintenance

Engineered Marble Tops

ATTENTION! The engineered marble top surface is very sensitive to acid-alkaline liquids and materials, such as toothpaste, hand soap, cologne, perfume, nail polish remover, hair color and perm products, shampoo, drain and toilet bowl cleaner, alcohol, lemon juice, medications, etc.... Please make sure to avoid these acid-alkaline liquids and materials to reach on the top surface. In case of spill, wipe it off immediately. Always clean the surface and keep it dry after the use.

Nature Granite & Quartz

- The granite tops are pre-sealed at factory and require the resealing as a routine maintenance procedure at least every six months, more frequent application is recommended and may be required depending on the usage. Follow sealer manufacturer's recommendation. The granite vanity top and backsplash are made from natural stone slabs. Due to its natural stone beauty, every stone top will have its own unique characteristics such as veining, color variances and natural surface textures.
- All tops must be clean, dry and free of debris before application. Cleaning Instructions: Clean the top, backsplash and bowl using a non-abrasive cleaner with a soft cloth. NEVER use abrasive cleaners, tub and tile cleaner, toilet cleaner, or rough cleaning pads. These types of cleaners can etch or dull stone surfaces. If necessary, a soft buffing pad can be used.
- Avoid placing sharp and/or heavy items on the vanity top and sink directly, and be aware of the fact that continuous direct exposure to sunshine, acid-alkaline liquid or chemicals, such as toothpaste, hand soap and lemon, can cause discoloring, staining, and other potential damage.

HOME
DECORATORS
COLLECTION®

Questions, problems, missing parts? Before returning to the store,
call Home Decorators Collection Customer Service
8 a.m. – 7 p.m., EST, Monday – Friday, 9 a.m. – 6 p.m., EST, Saturday

1-800-998-7021

[HOMEDEPOT.COM/HOMEDECORATORS](https://www.homedepot.com/homedecorators)