

FunTime Palace Popper 8oz Hot Oil Popcorn Machine



TABLETOP: FT824PP
W/ CART: FT865PP
INSTRUCTION MANUAL
(FOR AC 120V/60HZ)

IMPORTANT SAFEGUARDS

When using any electrical appliance, basic safety precautions should always be followed, including the following:

1. **READ ALL INSTRUCTIONS BEFORE USING YOUR POPCORN MACHINE.**
2. Do not touch hot surfaces. Always use handles or knobs to operate.
3. To avoid any risk of electrical shock, do not immerse cord or plug into water or other liquid.
4. Close supervision is necessary when it is being used by or near children.
5. Unplug main power cord from outlet while not in use and before cleaning.
6. Allow HOT parts to cool down before maneuvering.
7. Do not operate the appliance with damaged cord or plug, malfunction or with any mechanical damages. Send the unit to the nearest authorized service center for examination and repairs. (ONLY technicians should open up the unit)
8. Injury may be caused by using any accessories or attachments not provided by or recommended by manufacturer.
9. Do not pop the kernels with a dry pot (without oil).
10. Do not immerse kettle set into water.
11. Kettle surface is HOT and should NOT be touched during popping or just after use.
12. Unplug, clean, cover the unit, and store in a dry and safe place if not in use .
13. Do not leave power cord hanging over edge of a table or counter or touching with any hot surfaces.
14. Do not place the unit on or near a hot gas or electric burner or in a heated oven.
15. Extreme caution must be paid when moving the appliance containing hot oil or other hot liquids.
16. Turn ALL switches to "OFF" position before disconnecting power plug from the outlet.
17. Do not use appliance for other than indicated usage.
18. To avoid overheating, always add oil and then kernels .
19. Extreme caution must be paid when unloading hot popcorn. Always place the unit over a counter-top so that residual hot oil or water running out will not cause burns.
20. KEEP OUT OF REACH OF CHILDREN.
21. DO NOT CLEAN USING ANY ABRASIVE MATERIAL.
22. NEVER FORCE ANY PARTS OR BRACKETS INTO POSITION.
23. NO PARTS ARE INTENDED FOR THE DISHWASHER.

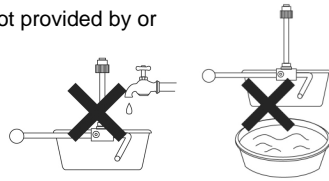

Assembling Parts

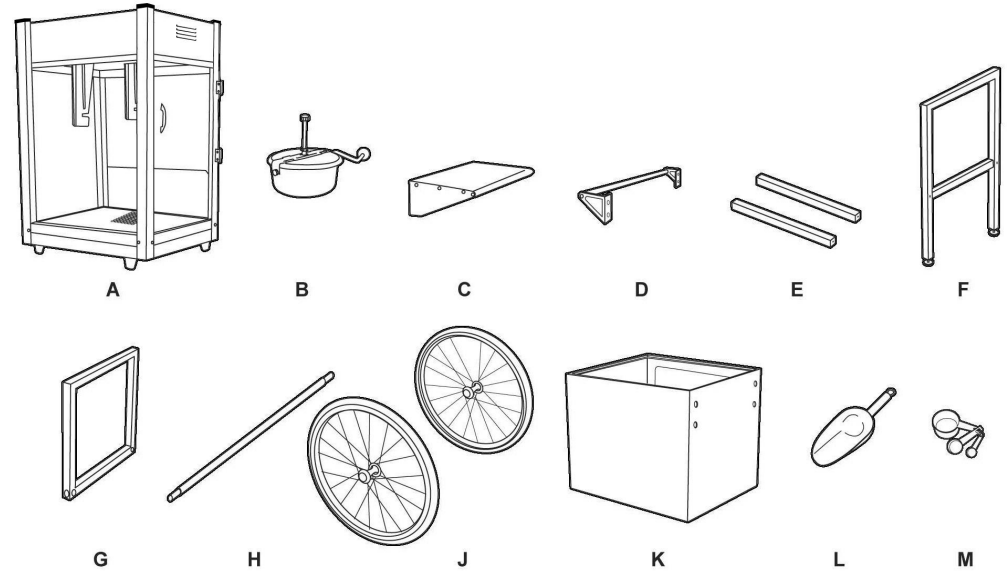

- | | |
|----------------------------|---------------------------------|
| A. Main unit x 1 pc | B. Kettle x 1 pc |
| C. Working platform x 1 pc | D. Hand rail x 1 pc |
| E. Square pole x 2 pcs | F. Long stand x 1 set |
| G. Short stand x 1 set | H. Wheel axle x 1 pc. |
| J. Wheels x 2 pcs. | K. Storage cabinet x 1 pc |
| L. Popcorn scoop x 1 pc | M. Kernel scoop + Oil scoop set |
- N. Parts x 1 box include:
- (Package A) bolts x 8 pcs. + nuts x 8 pcs. + washers x 8 pcs.
 - (Package B) bolts x 8 pcs. + washers x 4 pcs.,
 - (Package C) nuts with round cap x 2 pcs. + washers x 2 pcs.
 - (Package D) wrench x 2 pcs.

SAVE THESE INSTRUCTIONS

TABLETOP AND CART MODEL Assembling Parts

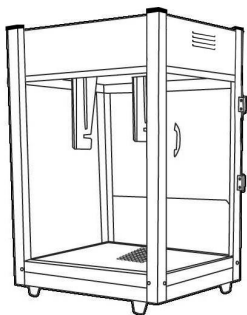

A



B



C



D

- A. Main unit x 1 pc
C. Popcorn scoop x 1 pc

- B. Kettle x 1 pc
D. Kernel scoop + Oil scoop set

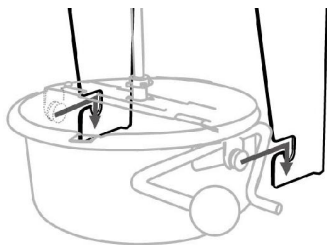

Assemble the kettle (B) on the supporters which are built into the main unit (A), and connect the cord from the unit to the socket in the ceiling.

CART MODEL ONLY

Assembling Procedures:

1. Use bolts & washers (Package B) provided to connect the Long stand (F) and the 2 pcs square pole (E) together.
2. Connect the completed above (1) with the short stand (G) by the bolts & washers (Package B).
3. Insert axle (H) into short stand. Place sleeves and washers (Package C) onto each side of wheels (J) and then fix it with round cap nuts by wrenches provided (Package D).
4. Turn the storage cabinet (K) up side down for convenient assembling. Insert both ends of the short and long stand into the bottom of (H) and then fix by bolts in (Package B).
5. Turn the complete unit back to up-right position. Install the handrail (D) onto the left hand & the working platform (C) on the right hand by bolts & nuts with washers included in (Package A).
6. Place the main unit (A) onto the topside of the storage cabinet.
7. Hook up the Kettle (B) onto the hanger. (Caution: Roller bar should be on the door side and also check if gears between pot and ceiling are perfectly matched).
8. Connect the power plug from the kettle to the socket in the ceiling.
9. Open the door of the storage cabinet and release the spring shafts beneath the main unit in order to fix the unit to the storage base.

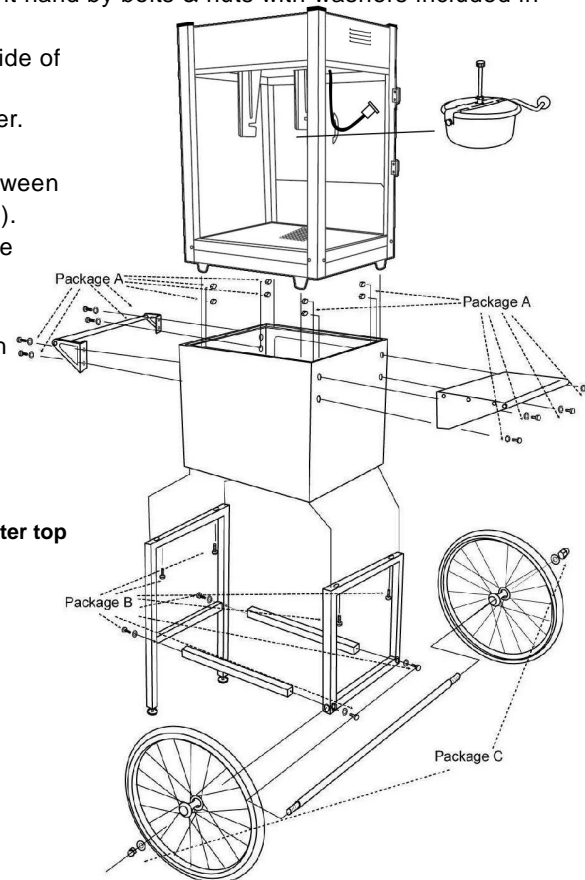

Note: Main unit alone can be used as a counter top for stand-alone operation

Operation Procedures:

User should follow these procedures:

- 1) Make sure the popcorn maker is unplugged before you do any of the following.
- 2) Before using this unit, please carefully check if voltage is suitable to your country's power.
(Please check if your voltage matches the rating label found next to the power cord).
- 3) Clean the inside of the kettle and popper with a damp towel before using for the first time.
- 4) Main unit has 3 function switches as follows:



Spot light and warmer (I)



Stirrer (II)



Stainless Steel Kettle Burner (III)

- 5) Hang the kettle on both of the hanger support arms inside the unit.
- 6) Plug the kettle power cord into the receptacle on the ceiling of the unit.
- 7) Switch on the light and heater (I & III), and then fill in suitable amount of oil (Fig. 1).
- 8) Kettle should be pre-heated for 3 to 4 minutes with oil (until steam comes out from the kettle).
- 9) Open the lid and then pour in pre-mixed kernel and salt. (Fig. 2)
Caution: Lid may be hot, it is recommended to use an oven mitt.
- 10) Switch ON the Stirrer (II) so that it starts stirring. (Fig. 3)
- 11) Close the door carefully.
- 12) Popcorn starts popping out through the lid after about 2 to 3 minutes. (Fig. 4)
- 13) Switch OFF the stirrer & heater (II & III) when popping completed (No more popping sound from kettle). Rotate the roller bar of the kettle and pour out all remaining popcorn from kettle.
- 14) Keep heater switch (III) OFF if the unit is not continuously running. Keep only the spot lamp/warmer ON to keep the popcorn warm, dry and tasty.
- 15) Serve your popcorn with popcorn scoop provided.
- 16) Remove plug from power supply if the unit is not in use.
- 17) Repeat steps 7 to 10 for continuous popping.

Fig. 1



Fig. 2

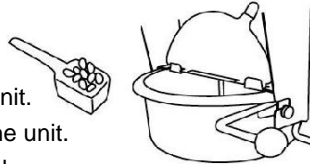

Fig. 3

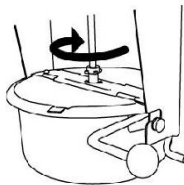
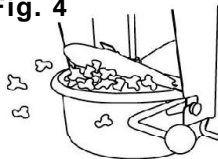

Fig. 4



Cleaning and Maintenance

To avoid build up in the bottom of the kettle, it is recommended that you clean the kettle frequently, or at least every 3 to 4 batches of popcorn.

After using the popcorn machine, users should use a damp towel to clean the main unit, main body and glass. Empty and clean the kernel tray frequently to avoid bacteria.

Quick Cleaning Procedure:

Switch OFF (II & III). Pour 8 to 12 oz of water (NO detergent is necessary) into kettle. Switch ON the stirrer (II) & heater (III) again to boil the water and let the stirrer to turn in order to remove excess amount of debris stuck on the surface. Pour out the water after about 1 to 2 minutes of boiling. **Caution: Kettle will be VERY HOT!** Repeat directions above 2 to 3 times for best results.

Standard cleaning procedure:

1. Repeat the above "Quick cleaning procedure" until the unit is relatively clean.
2. Switch off the machine and wait for the kettle to cool completely. Clean the inside and outside of the kettle with a soft brush and wet towel. (NEVER immerse the kettle into water.)

Spare part components

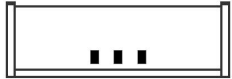

Housing
PC865-105



Block plate
PC862-109



Kettle
PC860-111

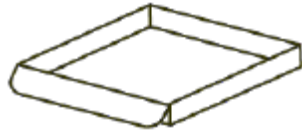

Crumb tray
PC862-110



Glass front door
PC865-106



Lamp holder
PC862-104



Upper gear housing
PC865-102



Side glass panel
PC865-107



Lower gear housing
PC865-103

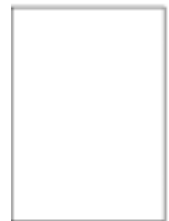

Back glass panel
PC865-108

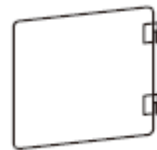

Cart Door w/ Hinge & Handle
PC865-120

Trolley components

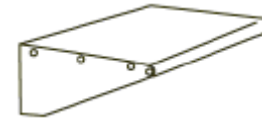

Working platform
PC862-112RG/BS



Short stand
PC862-116R/B

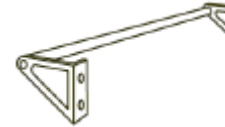

Handrail
PC862-113RG/BS

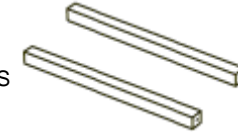

Square poles
PC862-114R/B



Wheels
PC862-118RG/BS



Long stand
PC862-115R/B



Package B
PC-Package-B



Package C
PC-Package-C



Package A
PC-Package-A

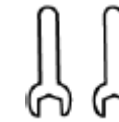

Package D
PC-Package-D



Measuring cup set
PC101B



Popcorn scoop
PC101A



Wheel Axle
PC862-117R/B

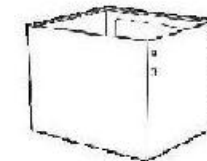

Square Storage Cabinet
PC862-119R/B