



CORDLESS TILLER + CULTIVATOR – CORE TOOL

24-VOLT MAX* | 6" STEEL TILLING BLADES

OPERATOR'S MANUAL

A Division of Snow Joe®, LLC

24V-TLR-CT

Form No. SJ-24V-TLR-CT-880E-MR1

IMPORTANT! Safety Instructions

All Operators Must Read These Instructions Before Use

Always follow these safety guidelines. Failure to do so may result in serious bodily injury or death.

General Safety WARNINGS!

You and any other operator of this cordless tiller + cultivator must read, understand, and follow these instructions in their entirety. Failure to follow these instructions may result in ELECTRIC SHOCK, FIRE, and/or serious PERSONAL INJURY.

Notice the personal safety alert symbol  used in this manual to draw your attention to a WARNING given along with the particular operating instruction. This means that the operation requires special ATTENTION, CAUTION, and AWARENESS.

- 1. Keep work area clean and well-lit** – Cluttered, dark areas invite accidents.
- 2. Replacement parts** – When servicing this unit, use only identical replacement parts. Replace or repair damaged parts immediately.
- 3. Keep children, bystanders, and pets away** – All spectators, including pets, should be kept a safe distance away from the work area.
- 4. Know your product** – Know how to start and stop the machine. Be thoroughly familiar with the controls.
- 5. Use the right tool** – Do not use this machine for any job except that for which it was intended.
- 6. Dress properly** – Do not wear loose clothing or jewelry as such articles can become caught in moving parts. Wear a protective covering to contain long hair. Wearing rubber gloves and substantial non-slip footwear is recommended when working outdoors.
- 7. Avoid accidental starting** – Do not carry the cordless tiller + cultivator with your finger on the switch.

 **CAUTION!** Moving parts will continue to run for several seconds after turning off the machine.

- 8. Moving parts** – Keep hands and feet away from moving parts. Keep guards in place and in proper working order.
- 9. Do not force the tool** – It will perform better with less likelihood of personal or mechanical injury if it is used at the rate for which it was designed.
- 10. Do not overreach** – Keep proper footing and balance at all times.

If the cordless tiller + cultivator strikes a foreign object, follow these steps:

- **Stop the cordless tiller + cultivator.**
 - **Inspect for damage.**
 - **Repair any damage before restarting and operating the tool.**
- 11. Use safety glasses** – Also use safety footwear, snug-fitting clothing, protective gloves, hearing, and head protection.
 - 12. Remove the battery** – Remove the battery from the cordless tiller + cultivator when it is not in use, before servicing it, when changing accessories, and when performing any other maintenance task.
 - 13. Store idle tool indoors** – When not in use, the cordless tiller + cultivator should be stored indoors in a dry and high or locked-up place out of the reach of children.
 - 14. Maintain the cordless tiller + cultivator with care** – Keep the cutting edges sharp and clean for optimal performance and to reduce the risk of injury. Keep the handles dry, clean, and free from oil and grease. Follow the additional recommendations described in the maintenance section of this manual.
 - 15. Avoid dangerous environments** – Do not use the tiller + cultivator in rain or in damp or wet locations. Do not operate the tiller + cultivator in gaseous or explosive atmospheres or use the tiller + cultivator near flammable or combustible liquids. Motors in these tools normally spark, and the sparks might ignite fumes.
 - 16. Stay alert** – Watch what you are doing. Use common sense. Do not operate the cordless tiller + cultivator when you are tired or under the influence of drugs, alcohol, or other medication.

- 17. Check for damaged parts** – Before further use of the appliance, a guard or other part that is damaged should be carefully checked to determine that it will operate properly and perform its intended function. Check for alignment of moving parts, binding of moving parts, breakage of parts, mounting, and any other condition that may affect its operation. A guard or other part that is damaged should be properly repaired or replaced. Contact the Snow Joe® + Sun Joe® customer service center at 1-866-SNOWJOE (1-866-766-9563) for assistance.

Training

- Read, understand, and follow all instructions on the cordless tiller + cultivator and in the manual before operating this unit. Thoroughly familiarize yourself with the controls and the proper use of the equipment. Know how to stop the unit and disengage the controls quickly.
- Children should never be allowed access to the equipment. Adults should never operate the equipment without carefully reading and understanding these instructions.
- Keep the area of operation clear of all persons, particularly children or pets.
- Exercise caution to avoid slipping or falling.
- Always plan your cultivating path to avoid discharge of material toward people, pets, and property (e.g. windows, cars, etc.). Thrown objects can cause serious personal injury and property damage. Do not allow anyone in front of a running machine.
- Keep people, pets, and property at least 25 feet from the cordless tiller + cultivator while it is in operation. Stop the cordless tiller + cultivator if people or pets enter the discharge area.
- Always observe the surface conditions in order to avoid slipping, falling, and unexpected objects.

Preparation

- Always inspect the area where the tiller + cultivator is to be used. Remove all objects (i.e. stones, sticks, wires, and other foreign materials) that could be thrown by the blades or cause the operator to trip.
- Thrown objects can cause serious injury to the eyes and exposed body. Always wear safety glasses or eye shields during operation and while making an adjustment or repair.
- Always operate the cordless tiller + cultivator wearing adequate garments. Do not wear jewelry or other loose clothing, which could become entangled in moving parts. Wear non-slip footwear to ensure proper footing.
- Observe any noise-prevention regulations and laws.
- Inspect the cordless tiller + cultivator for worn, missing, or damaged parts and safety labels. See maintenance section for detailed instructions.

Operation

- Do not operate the machine while under the influence of alcohol or drugs.
- Keep all safety devices in place and in proper working order. Do not operate with missing or damaged components.
- Ensure the controls (start/stop) function properly before cultivating.
- Hold onto the cordless tiller + cultivator with both hands during operation. Ensure the grips are dry.
- Contact with rotating parts can amputate hands and feet. Keep hands and feet away from all rotating parts.
- Only operate the cordless tiller + cultivator when there is good visibility or light and dry conditions. Always watch your footing and keep a firm hold on the grips. Walk; don't run!
- Do not operate the cordless tiller + cultivator on slippery surfaces. Check your footing during use.
- Exercise caution when changing direction and operating the tool on slopes. Always keep feet and legs a safe distance away from the machine. Look for hidden obstacles or hazards.
- Do not overload machine capacity by attempting to cultivate too deeply. It will cause excessive resistance.
- Stop the cordless tiller + cultivator and remove the battery before leaving the operating position (behind the handles) to adjust or inspect the unit. Wait until the blades have come to a complete stop.
- If the cordless tiller + cultivator should start to vibrate abnormally, stop the machine and inspect thoroughly for damage.
- Turn the machine OFF when moving to a new work area. Allow the blades to completely stop rotating before transporting the unit.
- Always use proper care and good judgment when you are confronted with a situation that is not covered in this manual. If you are unsure of what to do, contact your authorized Snow Joe® + Sun Joe® dealer or call the Snow Joe® + Sun Joe® customer service center at 1-866-SNOWJOE (1-866-766-9563).
- Do not use in rain or wet conditions.
- Do not grasp the exposed cutting blades or cutting edges when picking up or holding the appliance.

Stopping Work

- Always turn the cordless tiller + cultivator OFF and remove the battery when stopping work or when changing work areas. Never leave the machine running when unattended.
- The blades will continue to rotate for a short period after turning OFF the cordless tiller + cultivator. Wait until the blades have completely stopped before lifting the machine or conducting inspection and maintenance.

- The motor housing remains hot for a short period after the machine is turned OFF. Allow the motor housing to cool completely before touching or storing near combustible material.

Maintenance + Storage

- Maintain or replace safety and instruction labels.
- Disengage all controls, stop the engine, and wait until the blades come to a complete stop before cleaning, repairing, or inspecting the tiller + cultivator.
- Regularly check the following:
 - Blades are clear and can rotate freely –**
Accumulation of debris around the blades could impair performance or damage the motor. Inspect and clean the area around the blades before every use.
 - Safety devices are operating properly –**
Do not tamper with or adjust safety devices.
 - Bolts and screws are properly tightened –**
Visually inspect the machine for any damage and ensure that the cordless tiller + cultivator is in safe working condition.
 - Use only identical replacement parts –**
Always replace damaged parts with original equipment manufacturer's (OEM) parts only. Replacement parts that do not meet the original equipment specifications may lead to improper performance and compromise safety.

Battery & Charger Safety Instructions

NOTE: This unit is a core tool. The battery and the charger are not included. They must be purchased separately. Model 24V-TLR-CT is compatible with the iON+ 24V System batteries and chargers. See page 16 for more information.

We pay a great deal of attention to the design of every battery pack to ensure that we supply you with batteries that are safe, durable and have a high energy density. The battery cells have a wide range of safety devices. Each individual cell is initially formatted and its electrical characteristic curves are recorded. This data is then used exclusively to be able to assemble the best possible battery packs.

Despite all the safety precautions, caution must always be exercised when handling batteries. The following points must be obeyed at all times to ensure safe use. Safe use can only be guaranteed if undamaged cells are used. Incorrect handling of the battery pack can cause cell damage.

IMPORTANT! Analyses confirm that incorrect use and poor care of high-performance batteries are the main factors responsible for personal and/or product damage.

⚠️ WARNING! Use only approved replacement batteries; other batteries may damage the power tool and cause it to malfunction, which can lead to serious personal injury.

⚠️ WARNING! Do not use a battery pack or appliance that is damaged or modified. Damaged or modified batteries may exhibit unpredictable behavior resulting in fire, explosion or risk of injury.

Do not modify or attempt to repair the appliance or the battery pack except as indicated in the instructions for use and care.

Have your battery pack serviced by a qualified repair person using only identical replacement parts. This will ensure that the safety of the battery pack is maintained.

⚠️ CAUTION! To reduce the risk of injury, charge the 24V iON+ lithium-ion battery pack only in its designated 24V iON+ lithium-ion charger. Other types of chargers present risk of fire, personal injury and damage. Do not wire a battery pack to a power supply plug or car cigarette lighter. Such misuse will permanently disable or damage the battery pack.

- **Avoid dangerous environments –** Do not charge the battery pack in rain, snow or in damp or wet locations. Do not use the battery pack or charger in the presence of explosive atmospheres (gaseous fumes, dust or flammable materials) because sparks may be generated when inserting or removing the battery pack, which could lead to a fire.
- **Charge in a well-ventilated area –** Do not block the charger vents. Keep them clear to allow for proper ventilation. Do not allow smoking or open flames near a charging battery pack. Vented gases may explode.

NOTE: The safe temperature range for the battery is 41°F (5°C) to 105°F (40.5°C). Do not charge the battery outside in freezing weather; charge it at room temperature.

- **Maintain charger cord –** When unplugging the charger, pull the plug, not the cord, from the receptacle to reduce the risk of damage to the electrical plug and cord. Never carry the charger by its cord or yank it by the cord to disconnect it from the receptacle. Keep the cord away from heat, oil and sharp edges. Make sure the cord will not be stepped on, tripped over or subjected to damage or stress when the charger is in use. Do not use the charger with a damaged cord or plug. Replace a damaged charger immediately.
- **Do not use an extension cord unless it is absolutely necessary –** Using the wrong, damaged or improperly wired extension cord poses a risk of fire and electric shock. If an extension cord must be used, plug the charger into a properly wired 16 gauge or larger extension cord with the female plug matching the male plug on the charger. Make sure that the extension cord is in good electrical condition.
- **Use only recommended attachments –** Use of an attachment not recommended or sold by the battery charger or battery pack manufacturer may result in risk of fire, electric shock or personal injury.
- **Unplug charger when not in use –** Make sure to remove battery packs from unplugged chargers.

⚠ WARNING! To reduce the risk of electric shock, always unplug the charger before performing any cleaning or maintenance. Do not allow water to flow into the charger. Use a Ground Fault Circuit Interrupter (GFCI) to reduce shock hazards.

- **Do not burn or incinerate battery packs –** Battery packs may explode, causing personal injury or damage. Toxic fumes and materials are created when battery packs are burned.
- **Do not crush, drop or damage battery packs –** Do not use the battery pack or charger if they have sustained a sharp blow, been dropped, run over or have been damaged in any way (i.e. pierced with a nail, hit with a hammer, stepped on, etc.).
- **Do not disassemble –** Incorrect reassembly may pose a serious risk of electric shock, fire or exposure to toxic battery chemicals. If the battery or charger are damaged, contact an authorized Snow Joe® + Sun Joe® dealer or call the Snow Joe® + Sun Joe® customer service center at 1-866-SNOWJOE (1-866-766-9563) for assistance.
- **Battery chemicals cause serious burns –** Never let a damaged battery pack contact the skin, eyes or mouth. If a damaged battery pack leaks battery chemicals, use rubber or neoprene gloves to safely dispose of it. If skin is exposed to battery fluids, wash the affected area with soap and water and rinse with vinegar. If eyes are exposed to battery chemicals, immediately flush with water for 20 minutes and seek medical attention. Remove and dispose of contaminated clothing.
- **Do not short circuit –** A battery pack will short circuit if a metal object makes a connection between the positive and negative contacts on the battery pack. Do not place a battery pack near anything that may cause a short circuit, such as paperclips, coins, keys, screws, nails and other metallic objects. A short-circuited battery pack poses a risk of fire and severe personal injury.
- **Store your battery pack and charger in a cool, dry place –** Do not store the battery pack or charger where temperatures may exceed 105°F (40.5°C), such as in direct sunlight or inside a vehicle or metal building during the summer.

Information about the battery

1. The battery pack supplied with your cordless power tool is only partially charged. The battery pack has to be charged completely before you use the tool for the first time.
2. For optimum battery performance, avoid low discharge cycles by charging the battery pack frequently.
3. Store the battery pack in a cool place, ideally at 59°F (15°C) and fully charged.
4. Lithium-ion batteries are subject to a natural aging process. The battery pack must be replaced at the latest when its capacity falls to just 80% of its capacity when new. Weakened cells in an aged battery pack are no longer capable of meeting the high power requirements needed for the proper operation of your cordless tiller + cultivator, and therefore pose a safety risk.
5. Do not throw battery packs into an open fire as this poses a risk of explosion.
6. Do not ignite the battery pack or expose it to fire.
7. Do not exhaustively discharge batteries. Exhaustive discharge will damage the battery cells. The most common cause of exhaustive discharge is lengthy storage or non-use of partially discharged batteries. Stop working as soon as the performance of the battery falls noticeably or the electronic protection system triggers. Place the battery pack in storage only after it has been fully charged.
8. Protect batteries and the tool from overloads. Overloads will quickly result in overheating and cell damage inside the battery housing even if this overheating is not apparent externally.
9. Avoid damage and shocks. Immediately replace batteries that have been dropped from a height of more than 3 feet (1 meter) or those that have been exposed to violent shocks, even if the housing of the battery pack appears to be undamaged. The battery cells inside the battery may have suffered serious damage. In such instances, please read the waste disposal information for proper battery disposal.
10. If the battery pack suffers overloading and overheating, the integrated protective cutoff will switch off the equipment for safety reasons.
IMPORTANT! Do not press the ON/OFF trigger any more if the protective cut-off has been activated. This may damage the battery pack.
11. Use only original battery packs. The use of other batteries poses a fire risk and may result in injuries or an explosion.

Information about the charger and the charging process

1. Please check the data marked on the rating plate of the battery charger. Be sure to connect the battery charger to a power supply with the voltage marked on the rating plate. Never connect it to a different mains voltage.
2. Protect the battery charger and its cord from damage. Keep the charger and its cord away from heat, oil and sharp edges. Have damaged cords repaired without delay by a qualified technician at an authorized Snow Joe® + Sun Joe® dealer or call the Snow Joe® + Sun Joe® customer service center at 1-866-SNOWJOE (1-866-766-9563).
3. Electrical plugs must match the outlet. Never modify the plug in any way. Do not use any adapter plugs with grounded appliances. Unmodified plugs and matching outlets will reduce the risk of electric shock.
4. Keep the battery charger, battery pack(s) and the cordless tool out of the reach of children.
5. Do not use the supplied battery charger to charge other cordless tools.
6. During periods of heavy use, the battery pack will become warm. Allow the battery pack to cool to room temperature before inserting it into the charger to recharge.













7. Do not overcharge batteries. Do not exceed the maximum charging times. These charging times only apply to discharged batteries. Frequent insertion of a charged or partially charged battery pack will result in overcharging and cell damage. Do not leave batteries in the charger for days on end.
 8. Never use or charge batteries if you suspect that it has been more than 12 months since the last time they were charged. There is a high probability that the battery pack has already suffered dangerous damage (exhaustive discharge).
 9. Charging batteries at a temperature below 41°F (5°C) will cause chemical damage to the cells and may cause a fire.
 10. Do not use batteries that have been exposed to heat during the charging process, as the battery cells may have suffered dangerous damage.
 11. Do not use batteries that have suffered curvature or deformation during the charging process or those that exhibit other atypical symptoms (gassing, hissing, cracking, etc.).
 12. Never fully discharge the battery pack (maximum recommended depth of discharge is 80%). A complete discharge of the battery pack will lead to premature aging of the battery cells.
9. When handling batteries, be wary of electrostatic charge. Electrostatic discharges can damage the electronic protection system and the battery cells. Avoid electrostatic charging and never touch the battery poles.

Protection from environmental influences

1. Wear suitable work clothes. Wear safety goggles.
2. Protect your cordless tool and the battery charger from moisture and rain. Moisture and rain can cause dangerous cell damage.
3. Do not use the cordless tool or the battery charger near vapors and flammable liquids.
4. Use the battery charger and cordless tools only in dry conditions and at an ambient temperature of 41°F – 105°F (5°C – 40.5°C).
5. Do not keep the battery charger in places where the temperature is liable to reach over 104°F (40°C). In particular, do not leave the battery charger in a car that is parked in the sunshine.
6. Protect batteries from overheating. Overloads, overcharging and exposure to direct sunlight will result in overheating and cell damage. Never charge or work with batteries that have been overheated – replace them immediately, if possible.
7. Store the charger and your cordless tool only in dry locations with an ambient temperature of 40°F – 105°F (4.5°C – 40.5°C). Store your lithium-ion battery pack in a cool, dry place at a temperature of 50°F – 68°F (10°C – 20°C). Protect the battery pack, charger and cordless tool from humidity and direct sunlight. Only place fully charged batteries in storage.
8. Prevent the lithium-ion battery pack from freezing. Battery packs that were stored below 32°F (0°C) for more than 60 minutes must be discarded.

Safety Symbols





The following table depicts and describes safety symbols that may appear on this product. Read, understand, and follow all instructions on the machine before attempting to assemble and operate.

Symbols	Descriptions	Symbols	Descriptions
	READ THE OPERATOR'S MANUAL(S) – Read, understand, and follow all instructions in the user manual(s) before attempting to assemble and operate.		Wear eye protection, breathing protection, and ear protection (i.e. safety goggles, dust masks, and ear defenders).
	SAFETY ALERT – Indicates a precaution, a warning, or a danger.		WARNING! Do not expose the unit to rain or wet conditions.
	Beware of foreign objects that could be thrown from the appliance. Keep bystanders a safe distance away from the work area.		WARNING! Rotating parts may cause serious injury. Make sure the blades come to a complete stop before transporting the machine or before inspecting, cleaning, or conducting any other maintenance.
	Work across slopes; never work up and down such surfaces.		Inspect the work area prior to use and remove all objects that could be thrown by the appliance. If a hidden object is discovered while working, stop the engine and remove the object.
	Wear safety gloves during use to protect hands.		Wear safety footwear at all times to provide protection against objects that may accidentally fall on feet.
	The rotating part will continuously run for several seconds after you turn off the machine.		Indoor use only. Only use battery charger indoors.

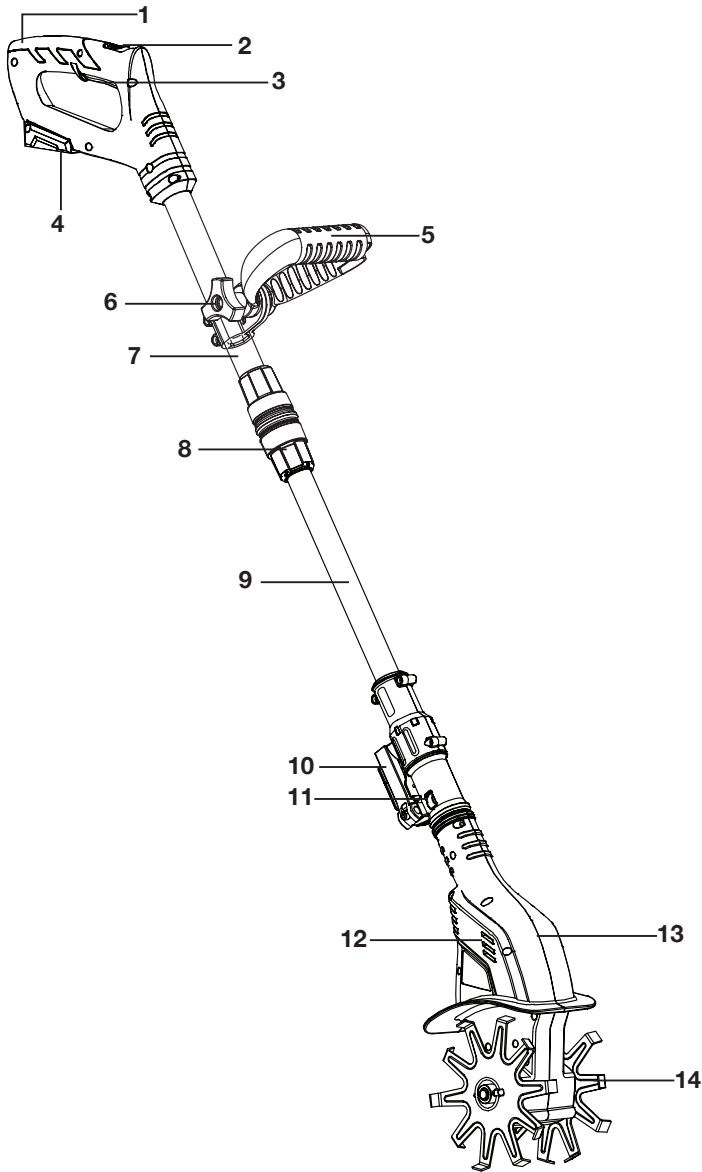
Know Your Cordless Tiller + Cultivator

Read the owner's manual and safety instructions carefully before operating the cordless tiller + cultivator. Compare the illustration below to the cordless tiller + cultivator in order to familiarize yourself with the location of the various controls and adjustments. Save this manual for future reference.

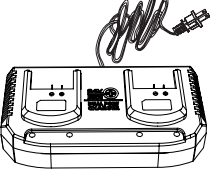

SOLD SEPARATELY	Battery + Charger options available at sunjoe.com
	
24VBAT-LTE	24VBAT-LT
	
24VBAT	24VBAT-XR
	
24VCHRG-QC	
	
24VCHRG-DPC	

- | | |
|------------------------|-----------------------------------|
| 1. Soft grip | 8. Telescoping lock |
| 2. Safety lock switch | 9. Telescoping pole |
| 3. ON/OFF trigger | 10. Tiller + cultivator head lock |
| 4. Battery compartment | 11. Releasing tabs (2) |
| 5. Auxiliary handle | 12. Air vents |
| 6. Handle knob | 13. Tiller + cultivator head |
| 7. Upper pole | 14. Steel blade (2) |

Technical Data

Battery Voltage*	24 V D.C.
Battery Capacity	See page 16 for battery options and specifications
Charging Time	See page 16 for battery options and specifications
Battery Run Time Max	See page 16 for battery options and specifications
Cultivating Width Max	4.1 in. (10.4 cm)
Blades	6 in. (15.2 cm) steel tilling blades
No Load Speed	280 rpm
Telescoping Pole Length	28.3 in. – 37.3 in. (72 cm – 95 cm)
Weight (without battery)	5.1 lbs (2.3 kg)

*Initial no-load voltage, when fully charged, peaks at 24 volts; nominal voltage under typical load is 21.6 volts.

Unpacking

Carton Contents

- Tiller + cultivator head
- Tiller + cultivator pole assembly
- Manual with registration card

NOTE: In order to operate this cordless tiller + cultivator you will need iON+ 24V System batteries and chargers. See page 16 for battery options and specifications, or visit sunjoe.com.

1. Carefully remove the cordless tiller + cultivator and check to see that all of the above items are supplied.
2. Inspect the product carefully to make sure no breakage or damage occurred during shipping. If you find damaged or missing parts, DO NOT return the unit to the store. Please call the Snow Joe® + Sun Joe® customer service center at 1-866-SNOWJOE (1-866-766-9563).

NOTE: Do not discard the shipping carton and packaging material until you are ready to use the cordless tiller + cultivator. The packaging is made of recyclable materials. Properly dispose of these materials in accordance with local regulations or save the packaging for long-term product storage.

IMPORTANT! The equipment and packaging material are not toys. Do not let children play with plastic bags, foils, or small parts. These items can be swallowed and pose a suffocation risk!

Battery Pack Operation

The equipment is powered by a lithium-ion battery. The battery pack is completely sealed and maintenance free.

CORE TOOL





BATTERY + CHARGER SOLD SEPARATELY

In order to operate this cordless tiller + cultivator you will need a iON+ 24V System battery and charger. See page 16 for battery and charger options and specifications, or for more information visit sunjoe.com.

Battery Charge Level Indicator

The battery pack is equipped with a push button for checking the charge level. Simply press the push button to read off the battery charge level from the LEDs of the battery indicator:

- All 3 level monitoring LEDs are lit: Battery charge level is high.
- 2 level monitoring LEDs are lit: Battery charge level is decreasing. Stop work as soon as possible.
- 1 level monitoring LED is lit: Battery is flat. Stop work IMMEDIATELY and charge the battery. Otherwise the battery's service life will be greatly shortened.

	
Lights	Light Indicators
	Charge level button
	The battery is at 30% capacity and requires charging
	The battery is at 60% capacity and requires charging soon
	The battery is at full capacity

NOTE: If the charge level button does not appear to be working, insert the charger and charge as needed.

NOTE: Immediately after using the battery pack, the charge level button may display a lower charge than it will if checked a few minutes later. The battery cells “recover” some of their charge after resting.

Charger Operation

CORE TOOL

BATTERY + CHARGER SOLD SEPARATELY

In order to operate this cordless tiller + cultivator you will need a iON+ 24V System battery and charger. See page 16 for battery and charger options and specifications, or for more information visit sunjoe.com.

⚠ WARNING! Charge only 24V iON+ lithium-ion battery packs with its compatible 24V iON+ lithium-ion charger. Other types of batteries may cause personal injury and damage. To reduce the risk of electric shock, do not allow water to flow into the charger's AC/DC plug.

When to Charge the iON+ 24V Lithium-iON Batteries

NOTE: The iON+ 24V lithium-ion battery packs do not develop a "memory" when charged after only a partial discharge. Therefore, it is not necessary to run down the battery pack before inserting the charger plug.

- Use the battery indicator lights to determine when to charge your iON+ 24V lithium-ion battery pack.
- You can "top-off" your battery pack's charge before starting a big job or after a long day of use.

Charging the Battery

1. Push the push lock buttons on the battery to pull the battery pack out from the battery compartment (Fig. 1).

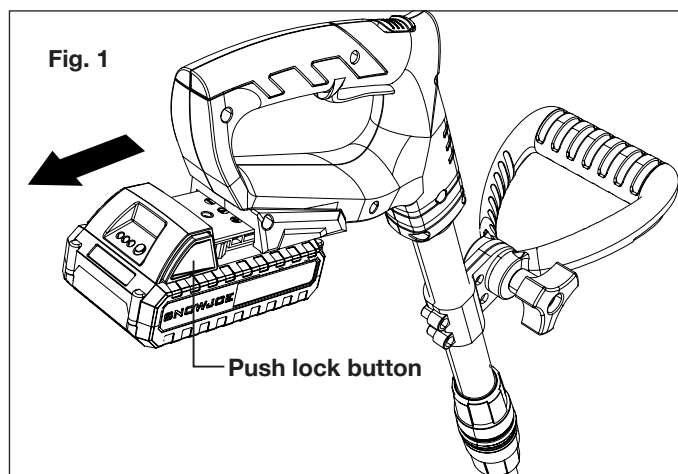

2. Depending on your Snow Joe® + Sun Joe® charger model, how to recharge your lithium-ion battery will vary. You may either insert your 24-volt battery into the 24VCHRG-QC Quick Charger (sold separately) or the 24VCHRG-DPC Dual Port Charger (sold separately) (Figs. 2 – 3).

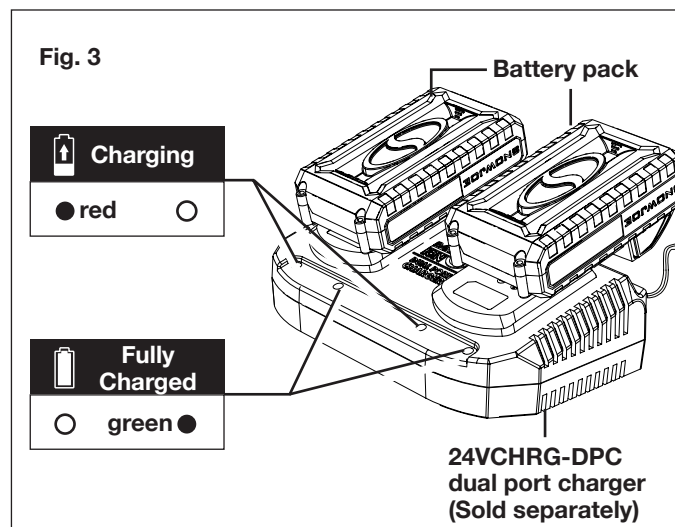
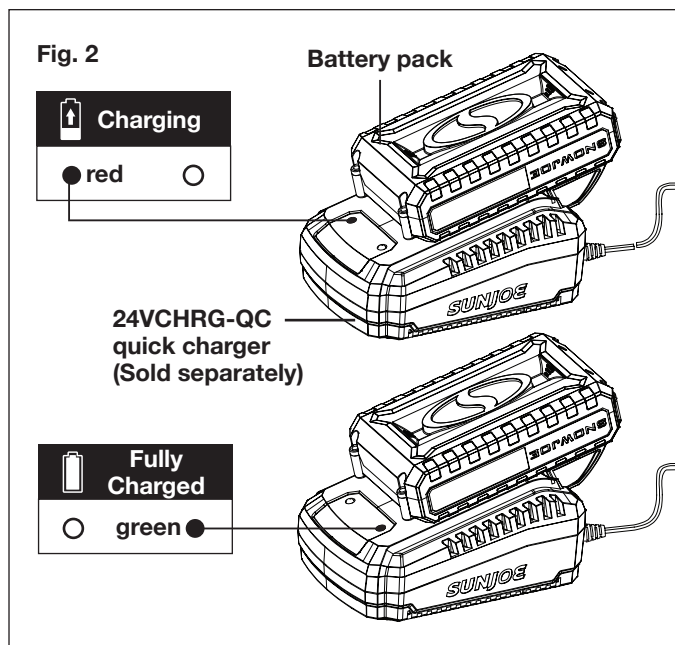

3. The battery indicator LEDs will illuminate one by one during the charging process. Unplug the charger immediately when the 3 LEDs are all illuminated.
4. The 24VCHRG-QC Quick Charger (sold separately) and the 24VCHRG-DPC Dual Port Charger (sold separately) are also equipped with additional charging indicating lights which will indicate the charging status (Figs. 2 – 3).

⚠ CAUTION! FIRE HAZARD. When disconnecting the charger from the battery, be sure to unplug the charger from the outlet first, then disconnect the charger from the battery.

⚠ WARNING! The chargers do not automatically turn off when the battery is fully charged. Please take care not to leave the battery plugged into the charger. Switch off or unplug the charger at the mains when charging is complete.

- Timely recharging of the battery will help prolong the battery's life. You must recharge the battery pack when you notice a drop in the equipment's power.

IMPORTANT! Never allow the battery pack to become fully discharged as this will cause irreversible damage to the battery.

- When charging is complete, remove the battery from the charger by pulling the push lock button and sliding the battery backward to unlock it from the charger.

Assembly

⚠️ WARNING! Do not insert the battery until assembly is complete. Failure to comply could result in accidental starting and serious personal injury.

⚠️ WARNING! To prevent serious personal injury, make sure the battery is removed, and the blades have come to a complete stop before inspecting, cleaning, or servicing the unit.

⚠️ WARNING! The product must be fully assembled before operation. Do not use a product that is only partially assembled or assembled with damaged parts.

Follow the assembly instructions step-by-step and use the pictures provided as a visual guide to easily assemble the product.

Assembling + Fitting the Head

- Remove the black cover on the tiller + cultivator head. With the tiller + cultivator head lock unlocked, insert the tiller + cultivator head into the end of the pole assembly until it clicks in place (Fig. 4).

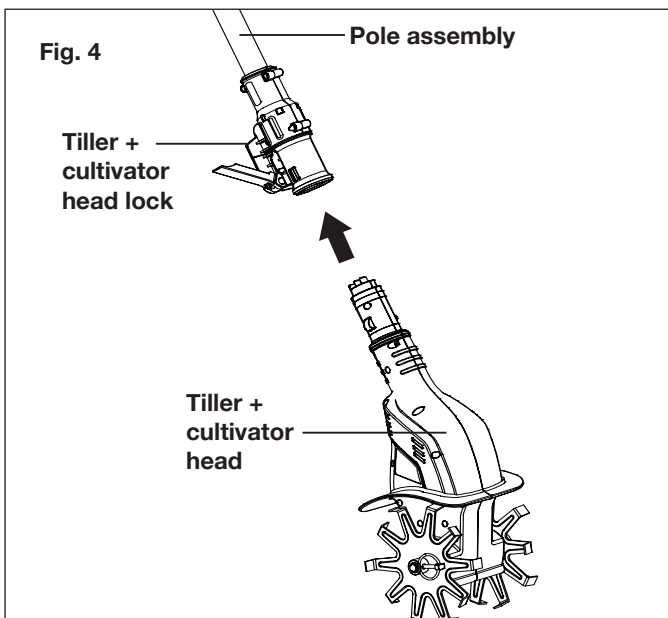

- Flip up the tiller + cultivator head lock to lock the tiller + cultivator head in place (Fig. 5).

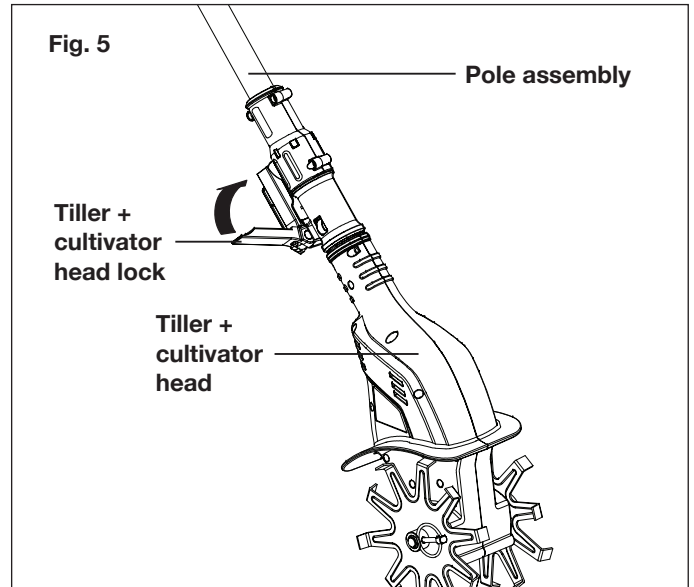

⚠️ WARNING! Make sure nuts, screws and locks are properly tightened before using the cordless tiller + cultivator.

- To disassemble the tiller + cultivator head from the pole assembly, unlock the tiller + cultivator head lock, then press in the releasing tabs on each side, and at the same time pull the tiller + cultivator head out from the pole assembly (Fig. 6).

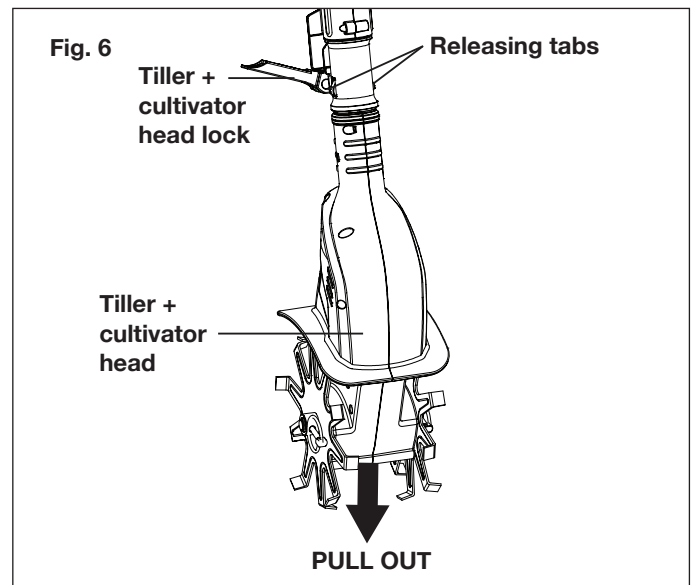

Operation

Intended Use

The 24V-TLR-CT cordless tiller + cultivator is designed for small gardens and flower beds: this cordless tiller + cultivator effectively loosens and turns over new soil. It may also be used to mix coarse soil with fertilizer, peat, and compost.

This product may not be used to till extremely dry or wet soil. The use of this product in rain or wet conditions is prohibited.

For safety reasons, it is essential to read the entire instruction manual before first use and to observe all the instructions contained within this manual.

This product is intended for private domestic use only. It is not intended for any commercial trade use. It must not be used for any purposes other than those described.

Telescoping Pole Adjustment

⚠️ WARNING! Always switch the product off and remove the battery before making any adjustments.

This product is equipped with a telescoping pole that can be adjusted. To adjust the pole, follow the instructions below.

1. Unlock the telescoping pole by turning the telescoping lock clockwise. Extend the pole to the desired length (Fig. 7).

NOTE: Push poles toward each other to shorten the pole or pull them away from each other to lengthen the pole. Only extend the pole to the minimum length required to reach the ground.

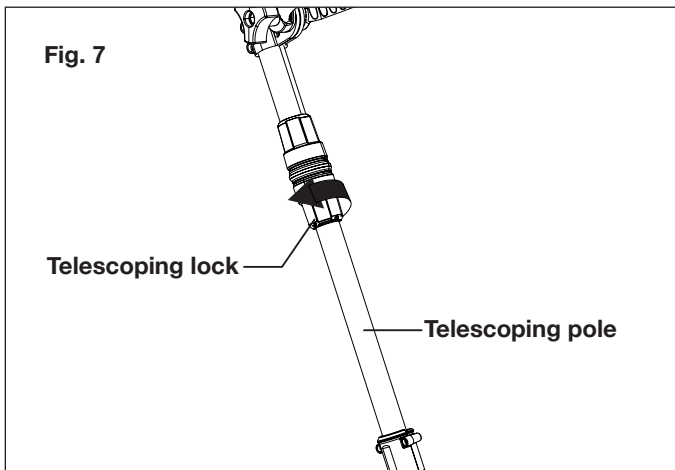

2. Lock the telescoping pole in position by turning the telescoping lock counterclockwise, and ensure that the pole is secured.

⚠️ WARNING! Always ensure the telescoping pole is securely locked. Do not attempt to use the product with the pole unlocked.

Auxiliary Handle Adjustment

⚠️ WARNING! Always switch the product off and remove the battery before making any adjustments.

NOTE: For maximum comfort and control, adjust the auxiliary handle to fit your height. Shorter users adjust the auxiliary handle to a lower position (away from your body).

Taller users adjust the auxiliary handle to an upper position (towards to your body). Make sure your forearm is straight when using the machine.

1. Loosen the auxiliary handle by turning the handle knob counterclockwise (Fig. 8).

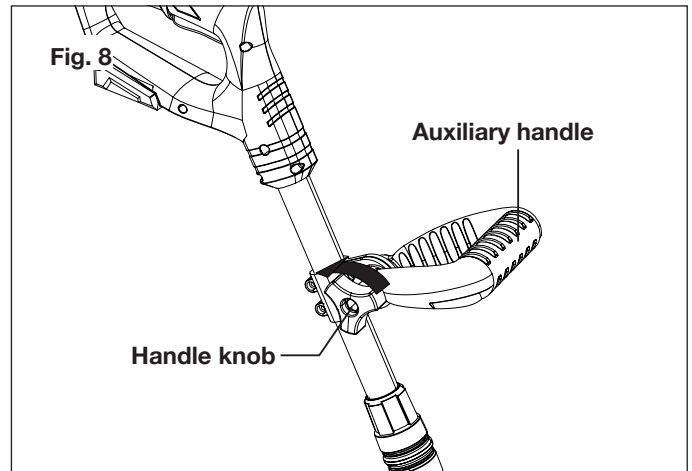

2. Adjust the auxiliary handle to a comfortable working position (Fig. 9).

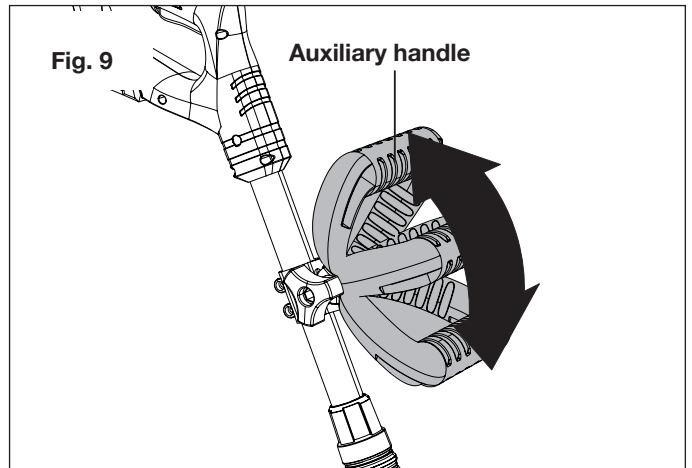

3. Turn the handle knob back to lock the auxiliary handle in position.

Starting + Stopping

⚠️ WARNING! Rotating blades may cause serious injury. The blades will continue to turn for a few seconds after the tool has been switched OFF. Do not touch the rotating blades. Contact with hot components (i.e. motor housing, gear box, etc.) on the machine may cause burns. Allow the machine to cool before handling.

1. Slide the battery in the battery compartment until it clicks and locks into position (Fig. 10).

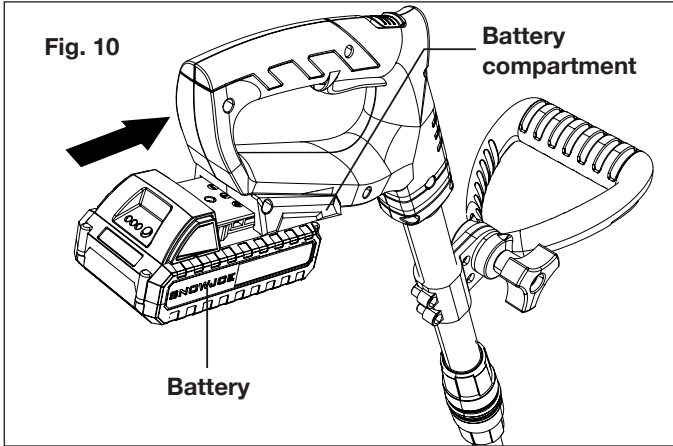

2. To turn the tool ON, push and hold the safety lock switch while squeezing the ON/OFF trigger. Once the tool is running, release the safety lock switch (Fig. 11).

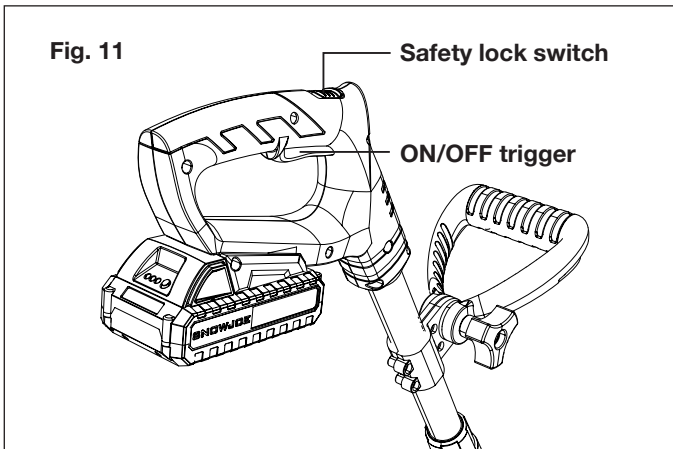

3. To switch OFF, release the ON/OFF trigger (Fig. 11).

Operating Tips

- Before each use, check the product, the battery, and any other accessories for damage. Do not use the product if it is damaged or shows wear.
- Double check that the accessories and attachments are properly fitted.
- Always hold the product by its handles. Keep the handles dry to ensure a secure grip.
- Ensure that the air vents are always unobstructed and clear. Clean them if necessary with a soft brush. Blocked air vents may lead to overheating and damage the product.
- Switch the product off immediately if you are disturbed while working by other people entering the working area. Always let the product come to a complete stop before averting your attention.
- Do not overwork yourself. Take regular breaks to ensure you can concentrate on the task at hand and have full control over the product.

⚠️ WARNING! In some municipalities, regulations define restrictions for use of such products, including the times and days when operation is permissible. Ask your community for detailed information and observe these regulations in order to preserve a peaceful neighborhood and avoid committing administrative offenses.

Tilling

- Make sure that the work area is clear of stones, sticks, wire, or other objects that could damage the product or its motor.
- Do not till very wet soil because wet soil tends to stick to the working tool, preventing proper blade rotation; it could also cause you to slip and fall.
- Always maintain a firm grip on the product. For better guidance, apply light pressure to the handles.

⚠️ WARNING! Do not place hands, feet, or any other part of the body or clothing near the rotating blades or any other moving part. The blades begin to rotate forward once the ON/OFF trigger is depressed. The blades continue to rotate until the ON/OFF trigger is released. Failure to avoid contact with the rotating blades could cause serious personal injury.

- Do not try to till too deeply or force the product into soil that is extremely hard or resistant.
- Walk the product through the soil at a normal pace and in as straight a line as possible.
- Till in slightly overlapping rows. To till most effectively, follow the pattern indicated in Fig. 12. Start by moving the tiller + cultivator up and down in vertical lines, then work horizontally from left to right. This will keep the rows even and ensure that all the ground is tilled without missing any spots.

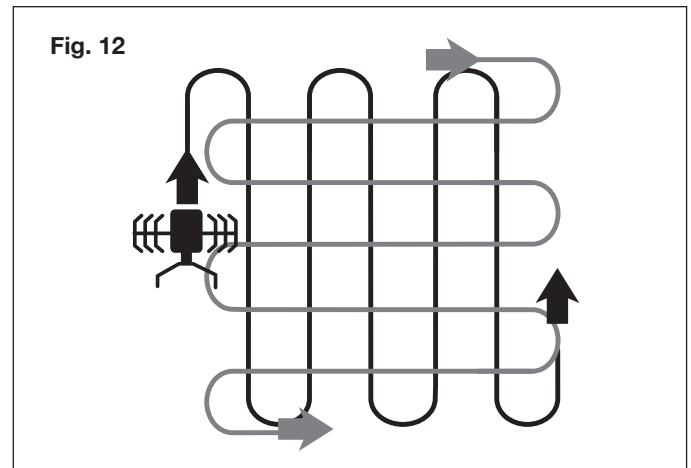

- Pay special attention when changing direction. Apply light pressure to the handle in order to lift the blades and facilitate the turn. Turn the product around using the wheels as a guide. Gradually release pressure on the handle and move the blades back to the ground.

⚠️ WARNING! Stop the motor if the product strikes a foreign object. Switch the product off, remove the battery, and let it cool completely. Inspect the product thoroughly for damage and have any damage repaired before restarting.

Extensive vibration of the product during operation is an indication of damage. Immediately stop the motor and promptly inspect and repair the tool.

After Use

- Switch the product off, remove the battery, and let it cool completely.
- Check, clean, and store the product as described in Care + Maintenance.

Care + Maintenance

The Golden Rules for Care

⚠️ WARNING! Always switch the product off, remove the battery, and let the product cool completely before inspecting, cleaning, or performing any other maintenance task.

- Keep the product clean. Remove any debris after each use and before storage.
- Regular and proper cleaning will help ensure safe use and prolong the life of the product.
- Inspect the product before each use for worn and damaged parts. If you find broken and/or worn parts, do not use the tool.

⚠️ WARNING! Only perform the repairs and maintenance work described in this manual. Any other work must be performed by a qualified technician.

General Cleaning

- Clean the product with a dry cloth. Use a brush for areas that are hard to reach.
- Be sure to clean the air vents after every use with a cloth and brush.
- Remove stubborn dirt with high pressure air (max. 3 bar).

NOTE: Do not use chemical, alkaline, abrasive, or other aggressive detergents or disinfectants to clean this product as such substances might damage the tool's surfaces.

- Check for worn or damaged parts. Replace worn parts as necessary or contact the Snow Joe® + Sun Joe® customer service center at 1-866-SNOWJOE (1-866-766-9563) for repair before using the product again.

Cleaning the Underbody + Working Tool

⚠️ WARNING! Wear safety gloves when working on or near the working tool. Use appropriate tools (e.g a wooden stick) when necessary; never use your bare hands!

- Keep the underbody and blades clean and free of debris. Use a brush or another implement to remove soil from the working tool.

- All nuts and bolts must be checked periodically for tightness before operation. After prolonged use, especially in sandy soil conditions, the working tool will become worn and lose some of its original shape. Tilling efficiency will be reduced and the working tool should be replaced.
- Have worn or damaged working parts replaced with new ones of the same type by a qualified technician.
- To prolong the life span of the working tool and the product, lubricate the blades after each use.

⚠️ WARNING! Unexpected blade movement may cause personal injury. Before servicing, repairing, or inspecting the unit, turn the motor OFF and remove the battery. Wait for the blades to completely stop rotating before conducting inspection, cleaning, or maintenance.

Before and after each use, check the product and accessories (or attachments) for wear and damage. When necessary, only use identical replacement parts that are approved by the manufacturer.

IMPORTANT!

- Wear protective gloves when cleaning or maintaining the machine.
- Do not use cleaning fluids or solvents or spray the machine down with water (especially water under pressure) when cleaning the machine.

NOTE: After each use, follow these steps to properly clean the unit:

1. Remove soil, dirt, and foliage stuck in the blades, drive shaft, tool surface, and vents with a brush or dry cloth.
2. Spray or rub biodegradable oil onto the blades.
3. Clean soiled grips with a damp cloth.

Always inspect the machine for damaged and worn parts after each use. Check that safety features (i.e. labels, guards, etc.) are in place. Check that nuts, bolts, and screws are tight.

Replace the Tilling Blades

The machine is fitted with two 10 tine steel tilling blades that can easily be changed. Only use the original replacement part specified for this tiller + cultivator.

You can purchase replacement blades (Model 24V-TLR-BLD) and other genuine replacement parts by visiting us online at sunjoe.com or calling our toll-free customer service helpline at 1-866-SNOWJOE (1-866-766-9563). The use of parts that do not meet the original equipment specifications may lead to improper performance of the tiller + cultivator, may compromise operator safety and will void the manufacturer's warranty.

⚠️ WARNING! The tilling blades are sharp and can cause severe personal injury if handled incorrectly. Wrap the blades or wear protective gloves, and use extra caution when handling.

To replace the blades, follow the steps below:

1. Turn off the unit, remove the battery and wait until the blades have come to a standstill.
2. Open the ring on the lock pin, then slide the pin out of the hole on the old blade. Then, remove the old blade from the motor shaft (Fig. 13).

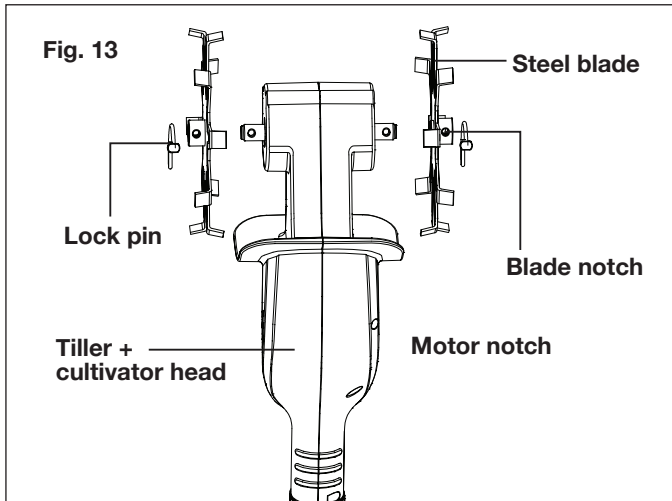

3. Insert the new blade onto the motor shaft. Make sure to align the notches on the blade's hole with the notches on the motor shaft (Fig. 13). Then, slide the lock pin into the holes of the blade and motor shaft to keep the blade in place. Close the ring over shaft to lock the pin. Insert the battery and resume working (Fig. 14).

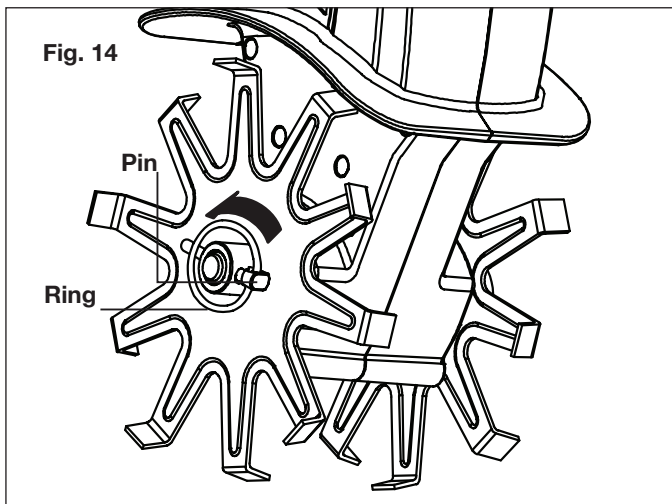

Repair

This product does not contain any parts that can be repaired by the consumer. Contact an authorized Snow Joe® + Sun Joe® dealer or call the Snow Joe® + Sun Joe® customer service center at 1-866-SNOWJOE (1-866-766-9563) for assistance.

Storage

- Examine the cordless tiller + cultivator thoroughly for worn, loose, or damaged parts. Should you need to repair or replace a part, contact an authorized Snow Joe® + Sun Joe® dealer or call the Snow Joe® + Sun Joe® customer service center at 1-866-SNOWJOE (1-866-766-9563) for assistance.
- Remove the battery from the cordless tiller + cultivator before storing.
- Clean the product as described in Care + Maintenance.
- Store the product and its accessories in a dark, dry, frost-free, and well-ventilated place.
- Always store the product in a place that is inaccessible to children.
- The ideal storage temperature is between 50°F (10°C) and 86°F (30°C).
- We recommend using the original package for storage or covering the product with a suitable cloth or enclosure to protect it against dust.

Battery + Charger Off-Season Storage

1. Do not expose your battery pack or charger to water, rain or allow them to get wet. This could permanently damage the charger and the battery pack. Do not use oil or solvents to clean or lubricate your battery pack as the plastic casing can become brittle and crack, causing a serious risk of injury.
2. Store the battery pack and charger at room temperature away from moisture. Do not store in damp locations where corrosion of terminals may occur. As with other battery pack types, permanent capacity loss can result if the pack is stored for long periods of time at high temperatures (over 120°F/49°C).
3. iON+ 24V lithium-ion battery packs maintain their charge during storage longer than other battery pack types. As a general practice, it is best to unplug the battery charger and remove the battery pack when they are not in use. Recharge the battery pack every 6 months to 50% capacity during off-season storage to maintain optimal battery performance.

Transportation

- Switch the product off.
- Always carry the product by its handle.
- If you are transporting the tiller + cultivator in a vehicle, brace it properly to protect it from heavy impact or strong vibrations.
- Secure the product to prevent it from falling over or slipping.

Recycling + Disposal

The product comes in a package that protects it against damage during shipping. Keep the package until you are sure that all parts have been delivered and the product is functioning properly. Recycle the package afterwards or keep it for long-term storage.



WEEE symbol. Waste electrical products should not be disposed of with household waste. Please recycle where facilities exist. Check with your local authority or local store for recycling regulations.

Battery Caution + Disposal

Always dispose of your battery pack according to federal, state, and local regulations. Contact a recycling agency in your area for recycling locations.

⚠ CAUTION! Even discharged battery packs contain some energy. Before disposing, use electrical tape to cover the terminals to prevent the battery pack from shorting, which could cause a fire or explosion.

⚠ WARNING! To reduce the risk of injury or explosion, never burn or incinerate a battery pack even if it is damaged, dead or completely discharged. When burned, toxic fumes and materials are emitted into the surrounding atmosphere.

1. Batteries vary according to device. Consult your manual for specific information.
2. Install only new batteries of the same type in your product (where applicable).
3. Failure to insert batteries in the correct polarity, as indicated in the battery compartment or manual, may shorten the life of the batteries or cause batteries to leak.
4. Do not mix old and new batteries.
5. Do not mix Alkaline, Standard (Carbon-Zinc) or Rechargeable (Nickel Cadmium, Nickel Metal Hydride, or Lithium-Ion) batteries.
6. Do not dispose of batteries in fire.
7. Batteries should be recycled or disposed of as per state and local guidelines.

Service + Support

If your Sun Joe® 24V-TLR-CT cordless tiller + cultivator requires service or maintenance, please call the Snow Joe® + Sun Joe® customer service center at 1-866-SNOWJOE (1-866-766-9563).

Model + Serial Numbers

When contacting the company, reordering parts, or arranging service from an authorized dealer, you will need to provide the model and serial numbers, which can be found on the decal located on the housing of the unit. Copy these numbers into the space provided below.

Record the following numbers from the housing or handle of your new product:	
Model #:	
2 4 V - T L R - C T	
Serial #:	

Optional Accessories

⚠️ WARNING! ALWAYS use only authorized Snow Joe® + Sun Joe® replacement parts and accessories. NEVER use replacement parts or accessories that are not intended for use with this cordless tiller + cultivator. Contact Snow Joe® + Sun Joe® if you are unsure whether it is safe to use a particular replacement part or accessory with your cordless tiller + cultivator. The use of any other attachment or accessory can be dangerous and could cause injury or mechanical damage.

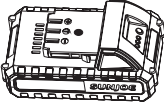
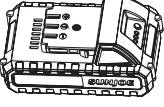
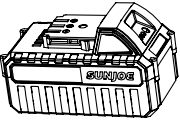
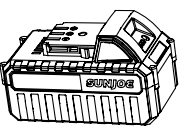
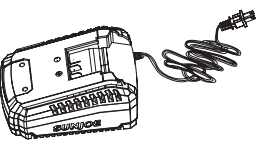
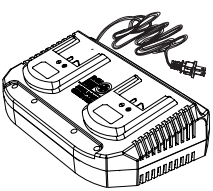
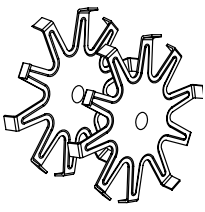
Accessories	Item	Model
<p>①</p> 	<p>24V iON+ 2.0 Ah Lithium-Ion Battery <i>Battery Charge Time Max:</i> 24VCHRG-AC: 1 hr 20 min 24VCHRG-QC: 55 min 24VCHRG-DPC: 55 min <i>Battery Runtime Max: 1 hr</i></p>	<p>24VBAT-LTE</p>
<p>②</p> 	<p>24V iON+ 2.5 Ah Lithium-Ion Battery <i>Battery Charge Time Max:</i> 24VCHRG-AC: 1 hr 40 min 24VCHRG-QC: 1 hr 10 min 24VCHRG-DPC: 1 hr 10 min <i>Battery Runtime Max: 1 hr 15 min</i></p>	<p>24VBAT-LT</p>
<p>③</p> 	<p>24V iON+ 4.0 Ah Lithium-Ion Battery <i>Battery Charge Time Max:</i> 24VCHRG-AC: 2 hrs 40 min 24VCHRG-QC: 1 hr 50 min 24VCHRG-DPC: 1 hr 50 min <i>Battery Runtime Max: 2 hrs</i></p>	<p>24VBAT</p>
<p>④</p> 	<p>24V iON+ 5.0 Ah Lithium-Ion Battery <i>Battery Charge Time Max:</i> 24VCHRG-AC: 3 hrs 20 min 24VCHRG-QC: 2 hr 20 min 24VCHRG-DPC: 2 hr 20 min <i>Battery Runtime Max: 2 hrs 30 min</i></p>	<p>24VBAT-XR</p>
<p>⑤</p> 	<p>24V iON+ Lithium-Ion Battery Quick Charger</p>	<p>24VCHRG-QC</p>
<p>⑥</p> 	<p>24V iON+ Lithium-Ion Battery Dual Port Charger</p>	<p>24VCHRG-DPC</p>
<p>⑦</p> 	<p>Replacement Blades (2)</p>	<p>24V-TLR-BLD</p>

NOTE: Accessories are subject to change without any obligation on the part of Snow Joe® + Sun Joe®. Accessories can be ordered online at sunjoe.com or via phone by contacting the Snow Joe® + Sun Joe® customer service center at 1-866-SNOWJOE (1-866-766-9563).

NOTES

NOTES



SNOW JOE® + SUN JOE® CUSTOMER PROMISE

ABOVE ALL ELSE, Snow Joe® + Sun Joe® are dedicated to you, our customer. We strive to make your experience as pleasant as possible. Unfortunately, there are times when a product does not work or breaks under normal operating conditions. We think it's important that you know what you can expect from us. That's why we created the Snow Joe® + Sun Joe® promise.

OUR PROMISE: Snow Joe® + Sun Joe® warrant new products for two years from the date of purchase. If your product does not work, or there's an issue with a specific part, we will fix this by either sending you a free replacement part or by sending you a new or comparable product at no charge. How cool is that! Before you know it, you'll be back in action cutting, sawing, mowing, washing and...?

PRODUCT REGISTRATION:

Snow Joe®, LLC ("Snow Joe® + Sun Joe®") strongly encourages you to register your purchase. You can register online at snowjoe.com/ProductRegistration, or by printing and mailing in a registration card available online from our website, or calling our Customer Service Department at **1-866-SNOWJOE (1-866-766-9563)**, or by e-mailing us at help@snowjoe.com. Failure to register your product purchase will not diminish your warranty rights. However, registering your purchase will allow Snow Joe® + Sun Joe® to better serve you with any of your customer service needs.

WHO CAN SEEK WARRANTY COVERAGE?

This Warranty is extended by Snow Joe® + Sun Joe® to the owner of this Machine (a "Machine" consists of a product powered by a motor) for residential and personal household use only. This Warranty does not apply to products used for commercial, rental or re-sale purposes. Should ownership of this machine change during the 2-year period, please update the Machine's owner information at snowjoe.com/ProductRegistration.

WHAT IS COVERED?

Snow Joe® + Sun Joe® warrants to the owner that if this Machine fails within 2 years from the date of purchase due to a defect in material or workmanship or as a result of normal wear and tear from ordinary household use, Snow Joe® + Sun Joe® will send a replacement part or product, as needed, free of charge and with free shipping to the original purchaser.

If, in Snow Joe® + Sun Joe®'s sole discretion, the failed Machine cannot be repaired with a part, Snow Joe® + Sun Joe® will elect to either (A) send a new Machine at no charge and with free shipping or (B) refund the full purchase price to the owner.

WHAT IS NOT COVERED?

This Warranty does not apply to the Machines that have been used commercially or in non-household applications. This Warranty does not cover cosmetic changes that do not affect performance. This Warranty is only valid if the Machine is used and maintained in accordance with the instructions, warnings and safeguards contained in the owner's manual. Snow Joe® + Sun Joe® will not be responsible for the cost of any unauthorized warranty repairs. This warranty does not cover any cost or expense incurred by the purchaser in providing substitute equipment or service during reasonable periods of malfunction or non-use of this product while waiting for a replacement part or unit under this warranty.

Wearing parts like belts, augers, chains and tines are not covered under this warranty, and can be purchased at snowjoe.com or by calling **1-866-SNOWJOE (1-866-766-9563)**. Batteries are covered in full for 90-days from the date of purchase.

Repair, replacement or refund of the purchase price are the exclusive remedies of purchaser and the sole liability of Snow Joe® + Sun Joe® under this warranty. No employee or representative of Snow Joe® + Sun Joe® is authorized to make any additional warranty or any modification to this warranty which may be binding upon Snow Joe® + Sun Joe®. Accordingly, purchaser should not rely upon any additional statements made by any employee or representative of Snow Joe® + Sun Joe®. In no event, whether based on contract, indemnity, warranty, tort (including negligence), strict liability or otherwise, shall Snow Joe® + Sun Joe® be liable for any special, indirect, incidental, or consequential damages, including, without limitation, loss of profit or revenue.

Some states do not allow limits on warranties. In such states, the above limitations may not apply to you.

Outside the USA, other warranties may apply.



sunjoe.com