

shindaiwa®

Operator's Manual EB600RT Power Blower

WARNING

The engine exhaust from this product contains chemicals known to the State of California to cause cancer, birth defects, or other reproductive harm.

WARNING



Read and understand all provided literature before use. Failure to do so could result in serious injury.

TABLE OF CONTENTS

Table of Contents	2
Introduction.....	3
Servicing Information.....	3
Parts/Serial Number	3
Service	4
Consumer Product Support.....	4
Product Registration.....	4
Additional Literature	4
Safety	4
Manual Safety Symbols and Important Information	4
International Symbols.....	5
Personal Condition and Safety Equipment	7
Equipment.....	12
Emission Control (Exhaust & Evaporative)	13
CARB And EPA Emissions Control Information.....	13
Description	14
Contents.....	16
Assembly.....	16
Install Blower Pipes	16
Operation.....	19
Fuel	20
Starting Cold Engine	23
Starting Warm Engine	24
Stopping Engine.....	24
Operating Blower	25
Cold Weather Operation	27
Adjust the Harness.....	28
Maintenance.....	28
Skill Levels	29
Maintenance Intervals	29
Air Filter	31
Fuel Filter	32
Spark Plug.....	33
Cooling System.....	34
Exhaust System	35
Carburetor Adjustment	38
Throttle Cable Adjustment.....	40
Troubleshooting.....	41
Storage.....	43
Long Term Storage (Over 30 Days).....	43
Specifications	44
Notes	45
Product Registration.....	46

INTRODUCTION

Specifications, descriptions and illustrative material in this literature are as accurate as known at the time of publication, but are subject to change without notice. Illustrations may include optional equipment and accessories, and may not include all standard equipment.



Read and understand all provided literature. Literature contains specifications and information for safety, operation, maintenance, storage and assembly specific to this product. Scan QR codes for more information.



For additional literature, including safety manuals where applicable, or questions regarding terms used in this manual, visit:

<https://www.echo-usa.com/manuals>

OR



<https://www.shindaiwa-usa.com/manuals>

SERVICING INFORMATION

Parts/Serial Number

Genuine SHINDAIWA Parts and Assemblies for your SHINDAIWA products are available only from an Authorized SHINDAIWA Dealer. When you do need to buy parts **always** have the Model Number and Serial Number of the unit with you. You can find these numbers on the engine housing. For future reference, write them in the space provided below.

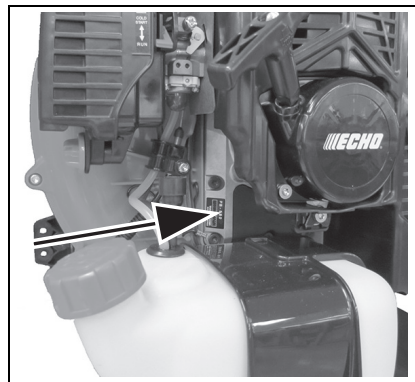

Model No. _____ Serial No. _____

Service

Service of this product during the warranty period must be performed by an Authorized SHINDAIWA Service Dealer. For the name and address of the Authorized SHINDAIWA Service Dealer nearest you, ask your retailer or call: 1-877-986-7783. Dealer information is also available on WWW.SHINDAIWA-USA.COM. When presenting your unit for Warranty service/repairs, proof of purchase is required.

Consumer Product Support

If you require assistance or have questions concerning the application, operation or maintenance of this product you may call the SHINDAIWA Consumer Product Support Department at 1-877-986-7783 from 8:00 am to 5:00 pm (Central Standard Time) Monday through Friday. Before calling, please know the model and serial number of your unit.

Product Registration

To ensure trouble free warranty coverage it is important that you register your SHINDAIWA equipment on-line at WWW.SHINDAIWA-USA.COM or by filling out the product registration sheet included in this manual. Registering your product confirms your warranty coverage and provides a direct link between you and ECHO if we find it necessary to contact you.

Additional Literature

In addition to finding information online, information is available from your Authorized Shindaiwa Service Dealer, or by contacting ECHO Inc., 400 Oakwood Road, Lake Zurich, IL 60047 (1-800-432-ECHO (3246)).

SAFETY

Manual Safety Symbols and Important Information

Throughout this manual and on the product itself, you will find safety alerts and helpful, informational messages preceded by symbols or key words. The following is an explanation of those symbols and key words and what they mean to you.

DANGER

The safety alert symbol accompanied by the word “DANGER” calls attention to an act or condition which **WILL** lead to serious personal injury or death if not avoided.

WARNING

The safety alert symbol accompanied by the word “WARNING” calls attention to an act or condition which **CAN** lead to serious personal injury or death if not avoided.

CAUTION

The safety alert symbol accompanied by the word “CAUTION” calls attention to an act or condition which may lead to minor or moderate personal injury if not avoided.

NOTICE

The enclosed message provides information necessary for the protection of the unit.



Note: This enclosed message provides tips for use, care and maintenance of the unit.















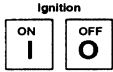

CIRCLE AND SLASH SYMBOL

This symbol means the specific action shown is prohibited. Ignoring these prohibitions can result in serious or fatal injury.

International Symbols

Symbol	Description	Symbol	Description
	Read and Understand the Operator's Manual	H	Carburetor Adjustment - High Speed Mixture
	Wear Eye, Ear and Head Protection	T	Carburetor Adjustment - Idle Speed
	Wear Hand Protection	L	Carburetor Adjustment - Low Speed Mixture

Symbol	Description	Symbol	Description
	Safety/Alert		Emergency Stop
	Hot Surface		Fuel and Oil Mixture
	Idle speed		Fast speed
	Finger severing		Primer Bulb
	DO NOT Allow Flames or Sparks Near Fuel		Ignition ON / OFF
	DO NOT Smoke Near Fuel		Choke Control "COLD START" Position (Choke Closed)
	Choke Control "RUN" Position (Choke Open)		Wear Slip Resistant Footwear
	Beware of thrown objects		
	Keep Bystanders and Helpers Away 15 m (50 ft.).		

Personal Condition and Safety Equipment

! WARNING

Cancer and Reproductive Harm
www.P65Warnings.ca.gov

! WARNING



The muffler or catalytic muffler and surrounding cover may become extremely hot. Always keep clear of exhaust and muffler area, otherwise serious personal injury may occur.

! WARNING

Users of this product risk injury to themselves and others if the unit is used improperly and/or safety precautions are not followed. Proper clothing and safety gear must be worn when operating unit.

Physical Condition

Your judgment and physical dexterity may not be good:

- If you are tired or sick
- If you are taking medication
- If you have taken alcohol or drugs

Operate unit only if you are physically and mentally well.

Eye Protection

WARNING

- ◆ **Eye protection that meets ANSI Z87.1 or CE requirements must be worn whenever you operate the unit.**
- ◆ **For additional safety, a full-face shield may be worn over safety glasses or goggles to provide protection from sharp branches or flying debris.**

Hand Protection

Wear sturdy, no-slip, rubber work gloves to improve your grip on the handles. Gloves also provide protection against cuts and scratches, cold environments, and reduce the transmission of machine vibration to your hands.

Hearing/Ear Protection

ECHO recommends wearing personal protection whenever unit is used.

Breathing Protection

Operators who are sensitive to dust or other common airborne allergens may need to wear a dust mask to prevent inhaling these materials while operating unit. Dust masks can provide protection against dust, plant debris, and other plant matter such as pollen. Make sure the mask does not impair your vision, and replace the mask as needed to prevent air restrictions.

Proper Clothing

Wear snug-fitting, durable clothing:

- Pants should have long legs, shirts should have long sleeves.
- DO NOT WEAR SHORTS.
- DO NOT WEAR TIES, SCARVES, JEWELRY, or clothing with loose or hanging items that could become entangled in moving parts or surrounding growth.
- Keep clothing buttoned or zipped, and keep shirt tails tucked in.
- Wear sturdy work shoes with nonskid rubber soles:
- DO NOT WEAR OPEN TOED SHOES.
- DO NOT OPERATE UNIT BAREFOOTED.

Keep long hair away from engine and air intake. Retain hair with cap or net.

Heavy protective clothing can increase operator fatigue, which may lead to heat stroke. Schedule heavy work for early morning or late afternoon hours when temperatures are cooler.

WARNING

The components of this machine generate an electromagnetic field during operation, which may interfere with some pacemakers. To reduce the risk of serious or fatal injury, persons with pacemakers should consult with their physician and the pacemaker manufacturer before operating this machine. In the absence of such information, ECHO does not recommend the use of this machine by anyone who has a pacemaker.

Extended Operation / Extreme Conditions

CAUTION

Prolonged exposure to cold and/or vibration may result in injury. Read and follow all safety and operation instructions to minimize risk of injury. Failure to follow instructions may result in painful wrist/hand/arm injuries.

It is believed that a condition called Raynaud's Phenomenon, which affects the fingers of certain individuals, may be brought about by exposure to vibration and cold. Exposure to vibration and cold may cause tingling and burning sensations, followed by loss of color and numbness in the fingers. The following precautions are strongly recommended, because the minimum exposure, which might trigger the ailment, is unknown.

- Keep your body warm, especially the head, neck, feet, ankles, hands, and wrists.
- Maintain good blood circulation by performing vigorous arm exercises during frequent work breaks, and also by not smoking.
- Limit the hours of operation. Try to fill each day with jobs where operating the unit or other hand-held power equipment is not required.
- If you experience discomfort, redness, and swelling of the fingers followed by whitening and loss of feeling, consult your physician before further exposing yourself to cold and vibration.

Repetitive Stress Injuries (RSI)

It is believed that overusing the muscles and tendons of the fingers, hands, arms, and shoulders may cause soreness, swelling, numbness, weakness, and extreme pain in those areas. Certain repetitive hand activities may put you at a high risk for developing a Repetitive Stress Injury (RSI). An extreme RSI condition is Carpal Tunnel Syndrome (CTS), which could occur when your wrist swells and squeezes a vital nerve that runs through the area. Some believe that prolonged exposure to vibration may contribute to CTS. CTS can cause severe pain for months or even years.

To reduce the risk of RSI/CTS, do the following:

- Avoid using your wrist in a bent, extended, or twisted position. Instead try to maintain a straight wrist position. Also, when grasping, use your whole hand, not just the thumb and index finger.
 - Take periodic breaks to minimize repetition and rest your hands.
 - Reduce the speed and force with which you do the repetitive movement.
- 
- Do exercises to strengthen the hand and arm muscles.
 - Immediately stop using all power equipment and consult a doctor if you feel tingling, numbness, or pain in the fingers, hands, wrists, or arms. The sooner RSI/CTS is diagnosed, the more likely permanent nerve and muscle damage can be prevented.

DANGER

All over head electrical conductors and communications wires can have electricity flow with high voltages. This unit is not insulated against electrical current. Never touch wires directly or indirectly, otherwise serious injury or death may result.

 **DANGER**

Do not operate this product indoors or in inadequately ventilated areas. Engine exhaust contains poisonous emissions and can cause serious injury or death.

Read the Manual

- Provide all users of this equipment with literature for instructions on safe operation.

Clear the Work Area

- Clear the area of children, bystanders, and pets. At a minimum, keep all children, bystanders, and pets outside a 15 m (50 ft.) radius; outside the 15 m (50 ft.) zone, there is still a risk of injury from thrown objects. Bystanders should be encouraged to wear eye protection. If you are approached, stop the engine.
- Avoid blowing debris towards people, pets, open windows, or vehicles when using unit.
- Review area to be cleared. Look for potential hazards such as stones or metal objects.

Keep a Firm Grip

- To prevent from dropping the unit, hold the handle in one hand, with thumb and fingers encircling the handle.

Keep a Solid Stance

- Maintain footing and balance at all times. Do not stand on slippery, uneven or unstable surfaces. Do not work in odd positions or on ladders. Do not over reach.

Avoid Hot Surfaces

- Keep exhaust area clear of flammable debris. Avoid contact during and immediately after operation.



Equipment

WARNING

Use only approved attachments. Serious injury may result from the use of a non-approved attachment combination. ECHO, INC. will not be responsible for the failure of cutting devices, attachments or accessories which have not been tested and approved by ECHO. Read and comply with all safety instructions listed in this manual.

- ◆ Do not attempt to modify this product. Serious injury can result from the use of any modified product.
- ◆ Check unit for loose/missing nuts, bolts, and screws. Tighten and/or replace as needed.
- ◆ Do not use blower if any part is missing or damaged.
- ◆ Have repairs done only by an authorized service dealer.

WARNING

Moving parts can amputate fingers or cause severe injuries. Keep hands, clothing and loose objects away from all openings.

- ◆ **ALWAYS** stop engine, disconnect spark plug, and make sure all moving parts have come to a complete stop before removing obstructions, clearing debris, or servicing unit.
- ◆ **DO NOT** start or operate unit unless all guards and protective covers are properly assembled to unit.
- ◆ **NEVER** reach into any opening while the engine is running. Moving parts may not be visible through openings.

WARNING

Periodically Check fuel system (fuel lines, vent, grommet, fuel tank, and fuel cap) for leaks especially if the unit is dropped. If damage or leaks are found, do not use unit, otherwise serious personal injury or property damage may occur. Have unit repaired by an authorized servicing dealer before using.

EMISSION CONTROL (EXHAUST & EVAPORATIVE)

CARB And EPA Emissions Control Information

The emission control system for the engine is EM (engine modification) and, if the second to last character of the Engine Family on the Emission Control Information label (sample below) is "B", "C", "K", or "T", the emission control system is EM and TWC (3-way catalyst). The fuel tank/fuel line emission control system is EVAP (evaporative emissions). Evaporative emissions for California models are only applicable to fuel tanks and fuel feed lines.



An Emission Control Label is located on the engine. (This is an **EXAMPLE ONLY**, information on label varies by engine FAMILY).

Product Emission Durability (Emission Compliance Period)



The 50 or 300 hour emission compliance period is the time span selected by the manufacturer certifying the engine emissions output meets applicable emissions regulations, provided that approved maintenance procedures are followed as listed in the Maintenance Section of this manual.

DESCRIPTION

Locate the safety decal(s) on your unit. Make sure the decal(s) is legible and that you understand and follow the instructions on it. If a decal cannot be read, a new one can be ordered from your dealer. Safety label is for example only. Your label may appear slightly different.

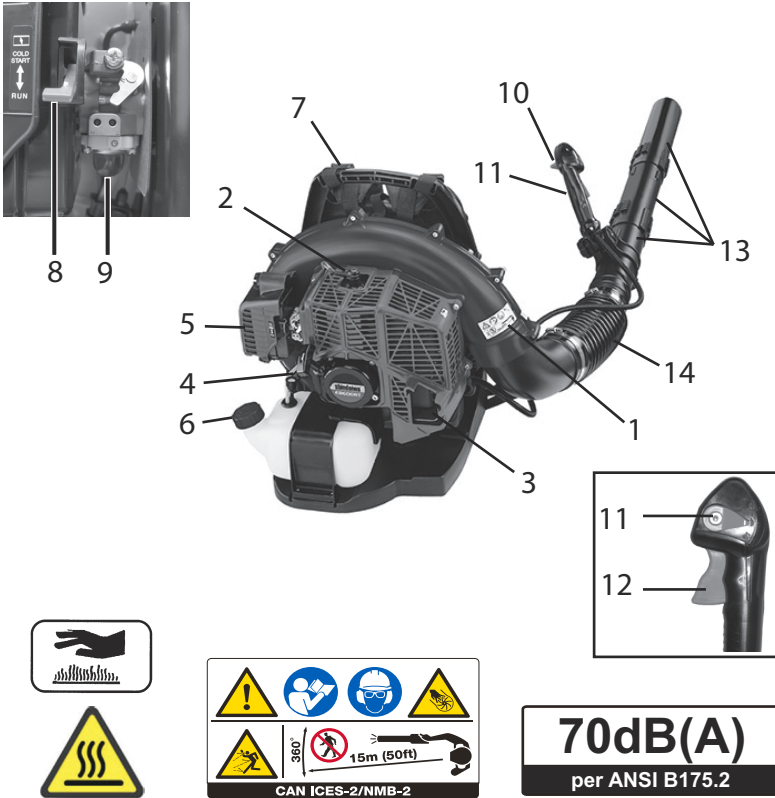

1. Safety Decal
2. Spark Plug

3. Spark Arrestor - Catalytic Muffler / Muffler
4. Recoil Starter
5. Air Cleaner
6. Fuel Tank Cap
7. Shoulder Harness
8. Choke
9. Purge Bulb
10. Handle
11. Throttle Position Lever
12. Throttle Trigger
13. Blower Pipes
14. Flexible Pipe

CONTENTS

The Shindaiwa product you purchased has been factory pre-assembled for your convenience. Due to packaging restrictions, some assembly may be necessary.

After opening the carton, check for damage. Immediately notify your retailer or Dealer of damaged or missing parts. Use the contents list to check for missing parts.

- 1 Power Head
- 1 Flex Pipe
- 1 Pipe with Swivel
- 1 Straight Pipe
- 1 Straight Pipe with Decal
- 1 Operator's Manual
- 1 Warranty Statement
- 2 Clamps with Screws

ASSEMBLY

WARNING

Never perform maintenance or assembly procedures with engine running or serious personal injury may result.

Install Blower Pipes

1. Assemble clamps (A) and (G) onto both ends of flexible pipe (B).

Note: Clamp with cable guide loop (G) fits elbow end of flexible pipe.

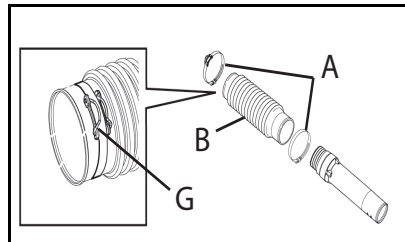

Note: Anti-static wire prior to assembly.

- 2. Route anti-static wire below fan housing and clip wire into throttle cable retaining clip (X). Position wire outside blower elbow.

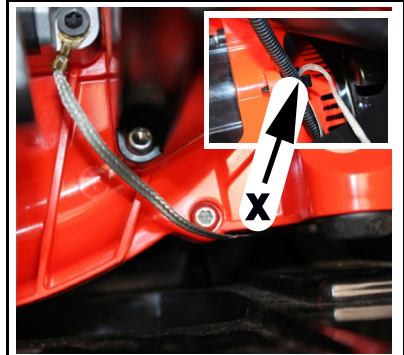

- 3. Insert anti-static wire through flex tube. Leave enough slack in anti-static wire to allow for full rotation of elbow.



Note: A light lubricant may be used to ease assembly of flexible pipe to blower elbow.

- 4. Assemble flexible pipe (B) to elbow (D) on blower. Position clamp with cable guide loop (G) on outside of flexible pipe (B) and tighten clamp.

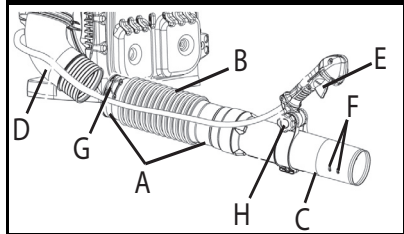

Note: Hang handle freely from blower to assure throttle cable is not twisted before installing handle (E).

5. Position cable along the outside of elbow. Loosen knob (H) on handle (E). Align notches in handle with tabs (F) and install onto swivel pipe (C) past long ridges in pipe.

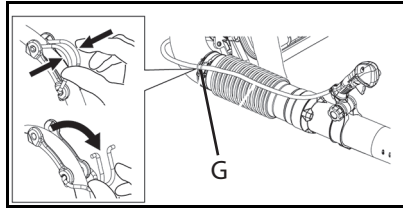

6. Insert anti-static wire through swivel pipe.
7. Assemble swivel pipe into flexible pipe and tighten clamp (A).
8. Clip throttle cable into throttle cable guide loop.

9. Move handle (E) to desired position. Tighten knob (H) hand tight.

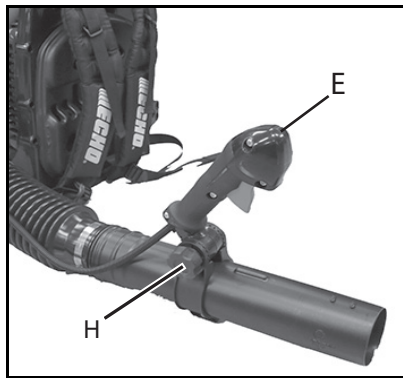

10. Assemble straight pipe (K) onto swivel pipe, until you feel light resistance. Hold swivel pipe and turn straight pipe clockwise, engaging positive locking channels, until connection is firm. Do not force connection.

11. Assemble straight pipe with decal (J) to straight pipe as in step 10.

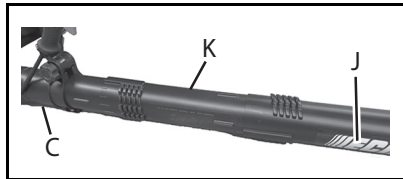

Note: Blower use will eventually loosen pipe connections. Exclusive positive locking system allows pipes to be tightened. If loosening occurs, remove two straight pipes and install according to instructions 10 & 11.

OPERATION

 WARNING

Moving parts can amputate fingers or cause severe injuries. Keep hands, clothing and loose objects away from all openings. Always stop engine, disconnect spark plug, and make sure all moving parts have come to a complete stop before removing obstructions, clearing debris, or servicing unit. Blower housing may contain shredder blades and other sharp edges that can cause serious injuries if touched, even if engine is off and blades are not moving. Wear gloves to protect hands from sharp edges and hot surfaces.

 WARNING

Operation of this equipment may create sparks that can start fires around dry vegetation. This unit is equipped with a spark arrestor to prevent discharge of hot particles from the engine. Contact local fire authorities for laws or regulations regarding fire prevention requirements.

 WARNING

Engine exhaust IS HOT, and contains Carbon Monoxide (CO), a poison gas. Breathing CO can cause unconsciousness, serious injury, or death. Exhaust can cause serious burns. ALWAYS position unit so that exhaust is directed away from your face and body.

 WARNING

- ◆ This blower should be used for clearing leaves, grass, debris, and dust in yards, gardens, driveways, and parking lots only.
- ◆ Always maintain a direct, clear line of site to the unit and the work being performed.
- ◆ Always be alert for changes in operation of unit.
- ◆ Always shut engine off before transporting unit to new location.
- ◆ Always secure the unit during transportation to prevent turnover, fuel spillage, and damage to the unit.

Fuel

 **WARNING**

Diesel fuels and alternative fuels, such as E15 (15% ethanol), E85 (85% ethanol) or any fuels not meeting Shindaiwa requirements are NOT approved for use in Shindaiwa 2-stroke or Hybrid 4-stroke gasoline engines. Use of diesel or alternative fuels may cause performance problems, loss of power, overheating, fuel vapor lock, and unintended machine operation, including, but not limited to, improper clutch engagement. Diesel or alternative fuels may also cause premature deterioration of fuel lines, gaskets, carburetors and other engine components.

Fuel Requirements

Gasoline - Use 89 Octane [R+M/2] (mid grade or higher) gasoline known to be good quality. Gasoline may contain up to 10% Ethanol (grain alcohol) or 15% MTBE (methyl tertiary-butyl ether). Gasoline containing methanol (wood alcohol) is **NOT** approved. Use of ECHO branded fuel is recommended to extend engine life in all air-cooled 2-stroke and 2/4-stroke hybrid engines.

Two Stroke Oil - A 2-stroke engine oil, such as Shindaiwa branded 2-stroke oils, meeting ISO-L-EGD (ISO/CD 13738) and J.A.S.O. FD Standards must be used. Shindaiwa branded 2-stroke oils meet these standards. Engine problems due to inadequate lubrication caused by failure to use an ISO-L-EGD (ISO/CD 13738) and J.A.S.O. M345-FD certified oil will void the 2-stroke engine warranty.

 **WARNING**

2-Stroke engine oil contains petroleum distillates and other additives that may be harmful if swallowed. Heated oil can release vapors that can cause flash fire, or ignite with explosive force. Read and follow the oil manufacturer's instructions, and observe all safety warnings and precautions for handling flammable liquids. For more detailed safety and first aid information, visit www.echo-usa.com for a copy of the Material Safety Data Sheet.

- ◆ **KEEP OUT OF REACH OF CHILDREN.**
- ◆ **If swallowed, do not induce vomiting. CALL PHYSICIAN OR A POISON CONTROL CENTER IMMEDIATELY.**

- ◆ **WEAR SAFETY GLASSES** when mixing or handling.
- ◆ **AVOID** repeated or prolonged skin contact.
- ◆ **AVOID** inhaling oil mists or vapors.

NOTICE

Shindaiwa branded 2-stroke oils may be mixed at 50:1 ratio for application in all Shindaiwa engines sold in the past, regardless of ratio specified in those manuals.

Handling Fuel

DANGER

Fuel is VERY flammable. Use extreme care when mixing, storing or handling, or serious personal injury may result.

- ◆ ***Use an approved fuel container.***
- ◆ ***DO NOT smoke near fuel.***
- ◆ ***DO NOT allow flames or sparks near fuel.***
- ◆ ***Fuel tanks/cans may be under pressure. Always loosen fuel caps slowly allowing pressure to equalize.***
- ◆ ***NEVER refuel a unit when the engine is HOT or RUNNING!***
- ◆ ***DO NOT fill fuel tanks indoors. ALWAYS fill fuel tanks outdoors over bare ground.***
- ◆ ***DO NOT overfill fuel tank. Wipe up spills immediately.***
- ◆ ***Securely tighten fuel tank cap and close fuel container after refueling.***
- ◆ ***Inspect for fuel leakage. If fuel leakage is found, do not start or operate unit until leakage is repaired.***
- ◆ ***Move at least 3 m (10 ft.) from refueling location before starting the engine.***

DANGER

Gasoline vapor is heavier than air, and can travel along the ground to nearby sources of ignition such as electrical motors, pilot lights, and hot or running engines. Vapors ignited by an ignition source can flash back to the fuel container, resulting in an explosion, fire, serious or fatal injuries, and extensive property damage.

Mixing Instructions

1. Fill an approved fuel container with half of the required amount of gasoline.
2. Add the proper amount of engine oil to gasoline.
3. Close container and shake to mix oil with gasoline.
4. Add remaining gasoline, close fuel container, and remix.

Fuel to Oil Mix – 50:1 Ratio			
US		Metric	
Gas	Oil	Gas	Oil
gal.	fl. oz.	L	cc
1	2.6	5	100
2	5.2	10	200
5	13	25	500

NOTICE

Spilled fuel is a leading cause of hydrocarbon emissions. Some states may require the use of automatic fuel shut-off containers to reduce fuel spillage.

After use

- Empty the fuel tank prior to storing the unit. Return unused fuel to an approved fuel storage container.

Storage - Fuel storage laws vary by locality. Contact your local government for the laws affecting your area. As a precaution, store fuel in an approved, airtight container. Store in a well-ventilated, unoccupied building, away from sparks and flames.

NOTICE

Stored fuel ages. Do not mix more fuel than you expect to use in thirty (30) days, ninety (90) days when a fuel stabilizer is added.

NOTICE

Stored 2-stroke fuel may separate. ALWAYS shake fuel container thoroughly before each use.

NOTICE

Used oil and gasoline, and soiled towels are hazardous waste materials. Disposal laws vary by locality.

Starting Cold Engine

- Recoil starter: Use short pulls - only 1/2- 2/3 of rope length for starting. Do not allow the rope to snap back in. Always hold the unit firmly.

1. *Throttle Lever*

Move throttle lever (A) to IDLE position.

2. *Choke*

Move choke (B) UP to COLD START (|↑|) position.

3. *Purge Bulb*

Pump purge bulb (C) until fuel is visible. Pump bulb an additional 4 or 5 times.

4. *Recoil Starter*

Pull recoil starter handle (D) until engine fires, or a maximum of 5 pulls

5. *Choke*

After engine fires (or 5 pulls), move choke lever back to RUN (|↓|) position, then pull starter handle/rope until engine starts and runs. Allow unit to warm up at idle for several minutes.

Note: If engine does not start with choke in "RUN" position after 5 pulls, move choke to COLD START (|↑|) position, and repeat steps 3- 5.

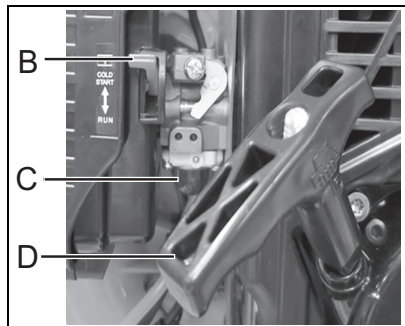
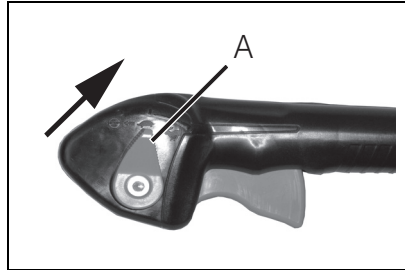

6. *Throttle Lever*

Allow engine to warm up for several minutes before use.

7. *Throttle Lever*

After engine warm-up, squeeze throttle trigger, then move throttle lever to set desired operating speed.

Starting Warm Engine

The starting procedure is the same as Cold Start except DO NOT close the choke.

1. *Throttle Lever*
Move throttle position lever (A) to IDLE position.
2. *Purge Bulb*
Pump purge bulb (C) until fuel is visible. Pump bulb an additional 4 or 5 times.
3. *Recoil Starter*
Pull recoil starter handle (D) and engine should start. Do not use choke (B)

Note: If engine does not start after 5 pulls, use cold start procedures.

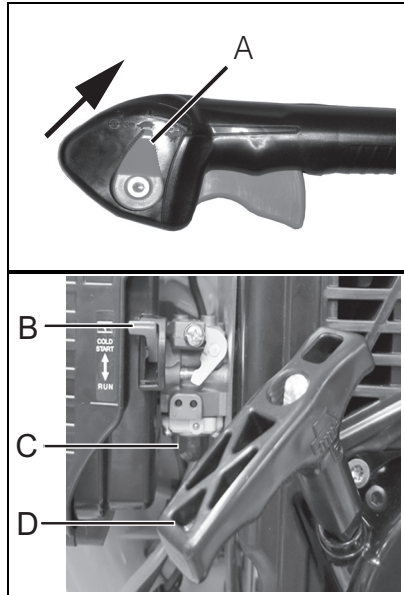

Stopping Engine

1. *Throttle Lever*
Release throttle trigger. Move Throttle Lever (A) forward to idle position and allow engine to return to idle before shutting off engine.
2. *Throttle Lever*
Move Throttle Lever (A) all the way forward to STOP position.

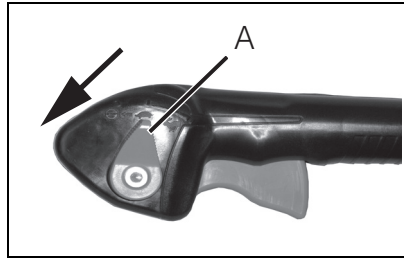

! WARNING

If engine does not stop when stop switch is moved to STOP position, close choke - COLD START position - to stall engine. Have your Shindaiwa dealer repair stop switch before using unit again.

Operating Blower

WARNING

Engine exhaust IS HOT, and contains Carbon Monoxide (CO), a poison gas. Breathing CO can cause unconsciousness, serious injury, or death. Exhaust can cause serious burns. ALWAYS position unit so that exhaust is directed away from your face and body.

WARNING

Always wear safety glasses, hearing protection and a face filter mask or serious personal injury may result. Do not point the blower pipe in the direction of people or pets.

NOTICE

Use reduced speed only when performing light-duty tasks or to comply with local noise regulations. Continuous low speed operation may allow fuel/oil residue to build-up on the piston and cause rapid build-up of carbon on the spark arrestor screen, resulting in overheating and engine damage. To reduce harmful build-up, run engine at wide open throttle for at least 5 minutes every hour, and inspect/clean the spark arrestor screen after approximately 40 hours of operation.

Read the Safety Section carefully.

NOTICE

To avoid engine damage due to over-revving, do not block blower pipe.

1. Use only during appropriate hours. Contact your local government for the ordinances affecting your area.
2. To reduce sound levels, limit the number of pieces of equipment used at any one time.

3. Allow the engine to warm up at a fast idle for a few minutes.
4. Control engine speed with throttle trigger (B), or for continuous use, set engine speed with throttle lever (A).
5. Use lower speed to blow dry leaves from walks, patios and drives. Use rakes and brooms to loosen debris before blowing.
6. Additional speed may be necessary to clean grass and leaves from a lawn or flower bed.
7. Higher speed may be necessary to move gravel, dirt, snow, bottles or cans from a driveway, street, parking lot or stadium.
8. Always stop unit using stop engine procedure.

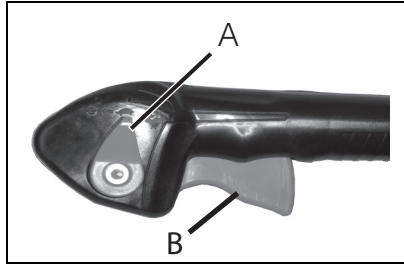

- Note: Never use a higher speed setting than necessary to perform a task. Remember, the higher the engine speed, the louder the blower noise.
9. Minimize dust by using blower at lower speeds or dampen surface with water. Blower can be used to clean most surfaces when water conservation is desired.
 10. Use the full blower pipe configuration when blowing.
 11. After using blowers and other equipment, CLEAN UP! Dispose of debris in trash receptacles.

CAUTION

Contacting blower pipe tip on abrasive surfaces can create sharp cutting edges and can result in personal injury if touched. Do not scrape or drag blower pipe tip when operating or transporting unit. Replace blower pipe assembly if protective metal ring is worn, cracked or deformed.

Cold Weather Operation

Plug

For operation in cold weather, install plug in cold weather position (D), otherwise icing can occur.

For operation in normal weather, install plug in warm weather position (C), otherwise over heating can occur.

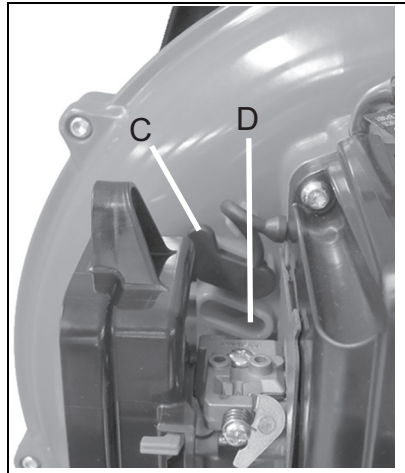

Intake Cover (optional)

In cold weather, intake cover can be installed for operator comfort. Intake cover is not included.

1. Remove back cushion (A) from frame.
2. Install intake cover (B) on frame over air intake.

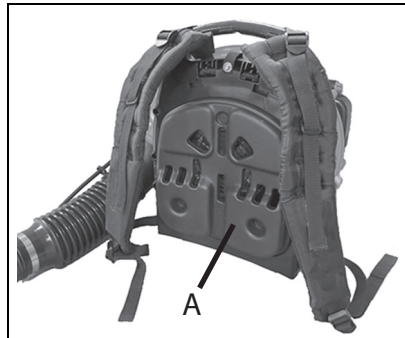

3. Install back cushion (A) to frame over intake cover.

Note: Blower performance may be reduced slightly.

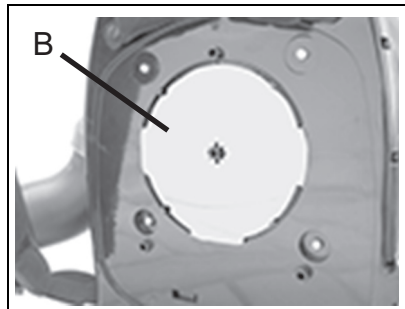

Adjust the Harness

1. Loosen upper and lower buckles (A), then put blower on your back.
2. Pull strap (B) downward to adjust position of blower.
3. Pull (C) to adjust angle between your back and the blower.

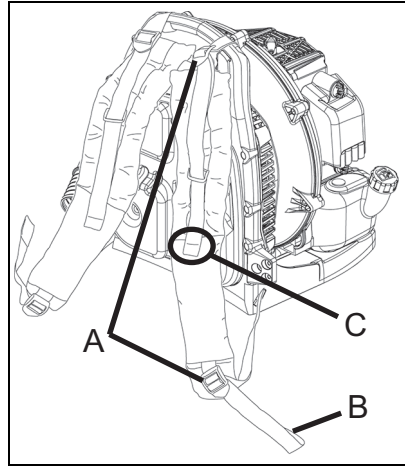

MAINTENANCE

! WARNING

Moving parts can amputate fingers or cause severe injuries. Keep hands, clothing and loose objects away from all openings. Always stop engine, disconnect spark plug, and make sure all moving parts have come to a complete stop before removing obstructions, clearing debris, or servicing unit. Allow unit to cool before performing service. Wear gloves to protect hands from sharp edges and hot surfaces.

! WARNING

Operating a poorly maintained unit can result in serious injuries to operator or bystanders. Always follow all maintenance instructions as written, otherwise serious personal injury may result.

Your unit is designed to provide many hours of trouble free service. Regular scheduled maintenance will help your unit achieve that goal. If you are unsure or are not equipped with the necessary tools, we recommend that you take your unit to a Servicing Dealer for maintenance. To help you decide whether you want to DO-IT-YOURSELF or have the Dealer do it, each maintenance task has been graded. If the task is not listed, see your Dealer for repairs.

NOTICE

The use of emission control components other than those specifically designed for this unit is a violation of federal law.

Skill Levels

Level 1 = Easy to do. Common tools may be required.

Level 2 = Moderate difficulty. Some specialized tools may be required.

Level 3 = See your dealer.

Click [HERE](#) or go to <http://www.echo-usa.com/products/maintenance-kit>

or

[HERE https://www.shindaiwa-usa.com/you-can.aspx](https://www.shindaiwa-usa.com/you-can.aspx)

For information about maintenance kits.

Maintenance Intervals

COMPONENT/SYSTEM	MAINTENANCE PROCEDURE	SKILL LEVEL
Daily or Before Use		
Air Filter	Inspect/Clean ¹	1
Choke Shutter		
Fuel System	Inspect	
Cooling System	Inspect/Clean	2
Recoil Starter Rope	Inspect/Clean 1	1
Screws/Nuts/Bolts	Inspect/Tighten/Replace ¹	
Every Refuel		
Fuel System	Inspect 1	1
Cooling System	Inspect/Clean	2
3 Months		

COMPONENT/SYSTEM	MAINTENANCE PROCEDURE	SKILL LEVEL
Air Filter	Replace ¹	1
Fuel Filter	Inspect ¹	
Fuel Cap Gasket		
Spark Plug	Inspect/Clean/Replace 1	
Muffler Spark Arrestor		
Cylinder Exhaust Port	Inspect/Clean/De-carbon	2
Yearly		
Fuel Filter	Inspect/Replace1	1
Fuel Cap Gasket	Replace 1	

IMPORTANT NOTE - Time intervals shown are maximum. Actual use and your experience will determine the frequency of required maintenance.

MAINTENANCE PROCEDURE NOTES:

¹: Replacement is recommended based on the finding of damage or wear during inspection.

Air Filter

Level 1.

Parts Required: Tune Up Kit.

1. CLOSE choke (COLD START [|>|] position). This prevents dirt from entering the carburetor throat when the air filter is removed. Brush accumulated dirt from air cleaner area.
2. Remove air filter cover. Brush dirt from inside cover.
3. Remove air filter and lightly brush debris from filter. Replace filter if it is damaged, fuel soaked, very dirty, or the rubber sealing edges are deformed.
4. If filter can be reused, be certain it:
 - Fits tightly in the air filter cavity
 - Is installed with the original side out
5. Install air filter cover.



Fuel Filter

Level 1.

Parts Required: Tune Up Kit.

DANGER

Fuel is VERY flammable. Use extreme care when mixing, storing or handling, or serious personal injury may result.

1. Use a clean rag to remove loose dirt from around fuel cap and empty fuel tank.
2. Pull the fuel line and filter from the tank.
3. Remove the filter from the line and install the new filter.

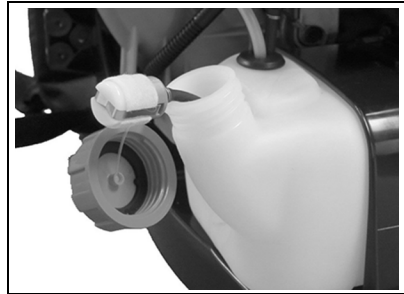

Note: Federal EPA regulations require all model year 2012 and later gasoline powered engines produced for sale in the United States to be equipped with a special low permeation fuel supply hose between the carburetor and fuel tank. When servicing model year 2012 and later equipment, only fuel supply hoses certified by EPA can be used to replace the original equipment supply hose. Fines up to \$37,500 may be enforced for using an un-certified replacement part.

Spark Plug

Level 2.

Parts Required: Tune Up Kit.

NOTICE

Use only NGK BPM8Y spark plug (BPMR8Y in Canada) otherwise severe engine damage may occur.

1. Remove spark plug and check for fouling, worn and rounded center electrode.
2. Clean the plug or replace with a new one. DO NOT sand blast to clean. Remaining sand will damage engine.
3. Adjust spark plug gap by bending outer electrode.
4. Tighten spark plug to 150-170 kgf • cm (130-150 in • lbf).

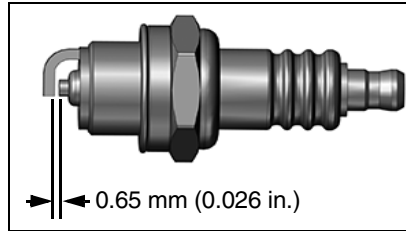

Cooling System

Level 2.

NOTICE

To maintain proper engine operating temperatures, cooling air must pass freely through the cylinder fin area. This flow of air carries combustion heat away from the engine.

Overheating and engine seizure can occur when:

- Air intakes are blocked, preventing cooling air from reaching the cylinder.
- Dust and grass build up on the outside of the cylinder. This build up insulates the engine and prevents the heat from leaving.

Removal of cooling passage blockages or cleaning of cooling fins is considered "Normal Maintenance." Any failure attributed to lack of maintenance is not warranted.

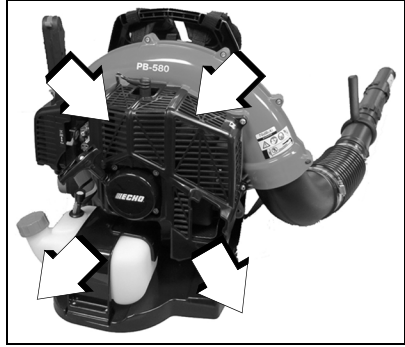

Cleaning Grill

1. Brush accumulated debris from intake grill between backpack frame and blower housing.

Cleaning Cylinder Fins

1. Remove spark plug.
2. Remove starter
3. Remove engine cover.
4. Clean cylinder fins (A) to allow cooling air to pass freely
5. Assemble components in reverse order.

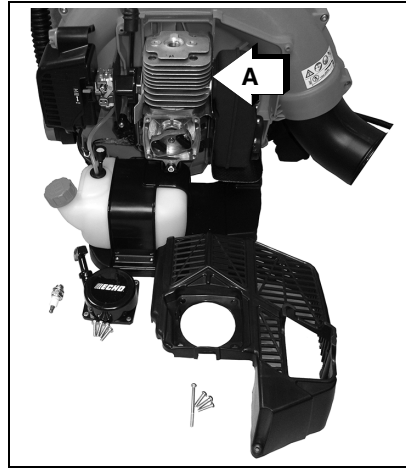

Exhaust System

Spark Arrestor Screen

Level 2.

Parts Required: Spark Arrestor Screen, Gasket

NOTICE

Carbon deposits in muffler will cause a drop in engine output and overheating. Spark arrestor screen must be checked periodically.

1. Remove spark plug.
2. Remove starter.
3. Remove engine cover.
4. Place piston at Top Dead Center (TDC) to prevent carbon/dirt from entering cylinder.

5. Remove spark arrestor cover (A), gasket (B) and spark arrestor screen (C) from muffler.
6. Clean carbon deposits from muffler components.

Note: When cleaning carbon deposits, be careful not to damage the catalytic element inside muffler.

7. Replace screen if it is cracked, plugged, or has holes burned through.
8. Replace gasket.
9. Assemble components in reverse order.

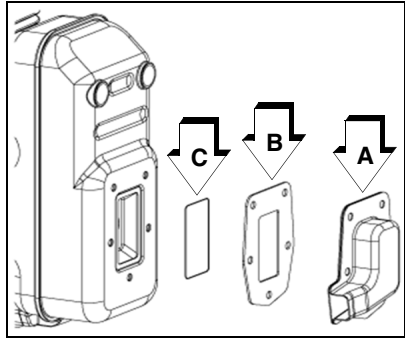

Exhaust Port Cleaning

Level 2.

Parts Required: Heat Shield

1. Remove spark plug.
2. Remove starter
3. Remove engine cover.
4. Place piston at top dead center. Remove muffler (A) heat shield (B).
5. Use a wood or plastic scraping tool to clean deposits from cylinder exhaust port.

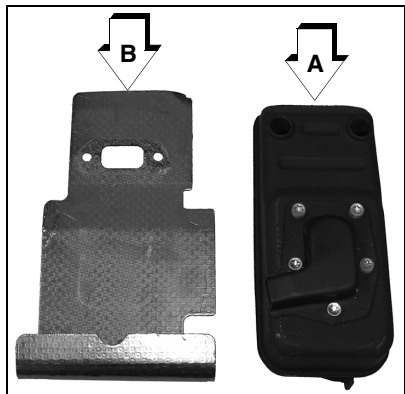

NOTICE

Never use a metal tool to scrape carbon from the exhaust port. Do not scratch the cylinder or piston when cleaning the exhaust port. Do not allow carbon particles to enter the cylinder.

6. Replace heat shield.

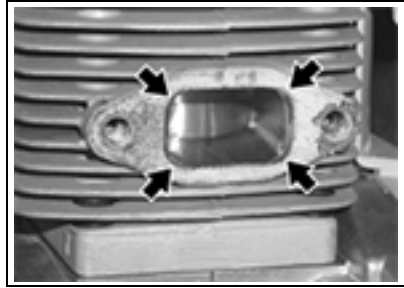

NOTICE

Assure heat shield is installed correctly behind rib (A) and in front of rib (B) in fan case.

7. Install muffler.
8. Tighten muffler mounting bolts (or nuts) to 90-110 kgf • cm (80-95 in • lbf).
9. Assemble components in reverse order.
10. Start engine, and warm to operating temperature.
11. Stop engine, and re-tighten mounting bolts (or nuts) to specifications.

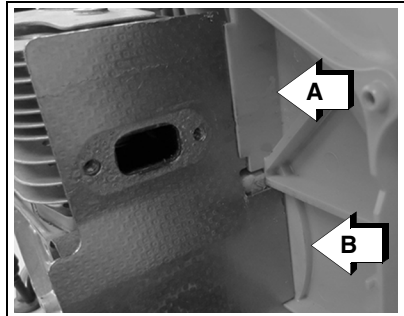

Carburetor Adjustment

Engine Break-In

New engines must be operated a minimum duration of two tanks of fuel break-in before carburetor adjustments can be made. During the break-in period your engine performance will increase and exhaust emissions will stabilize. Idle speed can be adjusted as required.

High Altitude Operation

This engine has been factory adjusted to maintain satisfactory starting, emission, and durability performance up to 1,100 feet above sea level (ASL) (96.0 kPa). To maintain proper engine operation and emission compliance above 1,100 feet ASL the carburetor may need to be adjusted by an authorized service dealer.

NOTICE

If the engine is adjusted for operation above 1,100 feet ASL, the carburetor must be re-adjusted when operating the engine below 1,100 feet ASL, otherwise severe engine damage may result.

Level 2.

Note: Every unit is run at the factory and the carburetor is set in compliance with emission regulations. Carburetor adjustments, other than idle speed, must be performed by an authorized dealer.

Idle Adjustment

Before adjustment make sure that:

- Air filter is clean and properly installed.
- Spark arrestor screen and muffler are free of carbon.
- Blower pipes are installed.

1. Start engine, run at idle for one minute.
2. Complete warm up by running at full throttle for 5 minutes, operating choke twice to clear air from carburetor chambers.
3. Check idle speed and reset if necessary. If a tachometer is available, idle speed screw (A) should be set to the specifications found on "Specifications" Page of this manual. Turn idle screw (A) clockwise to increase idle speed; counter clockwise to decrease idle speed.

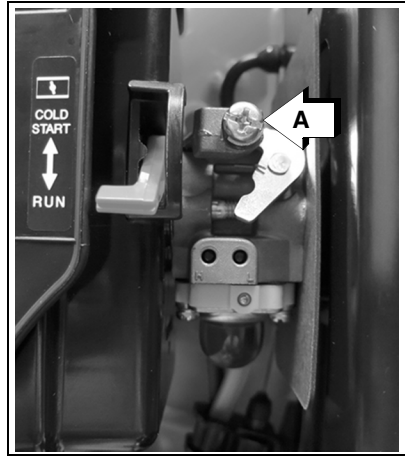

Throttle Cable Adjustment

Level 1

If engine idle speed changes when blower pipe is moved, or engine will not reach full wide open throttle speed, adjust throttle cable.

1. Loosen handle adjustment knob (C) and tilt Tube Throttle handle forward to expose Adjustment Screw (D).

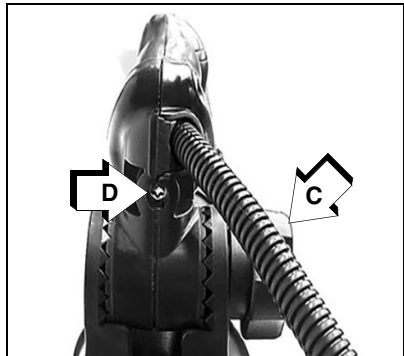

2. Turn Adjustment Screw until Throttle Trigger free play is 4 - 6 mm (3/16-1/4 in.).
3. After adjustment, squeeze and release Throttle Trigger several times to verify Carburetor Throttle Shaft has full range of movement from idle to wide open throttle positions.

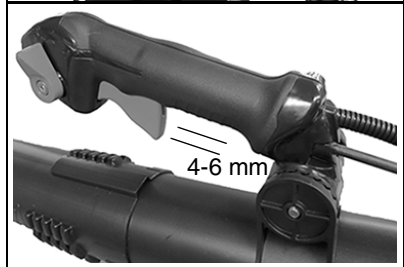

TROUBLESHOOTING

DANGER

Fuel vapors are extremely flammable and may cause fire and/or explosion. Never test for ignition spark by grounding spark plug near cylinder plug hole, otherwise serious personal injury may result.

ENGINE PROBLEM TROUBLESHOOTING CHART				
Problem	Check	Status	Cause	Remedy
Engine starts hard or Engine does not start	Fuel at carburetor	No fuel at carburetor	Fuel strainer or fuel line obstructed	Clean or replace See your dealer
		No fuel at cylinder	Carburetor	See your dealer
Engine starts hard or Engine does not start	Fuel at cylinder	Muffler wet with fuel	Fuel mixture too rich	OPEN choke Clean or replace air filter Adjust carburetor See your dealer
			No spark	Ignition at STOP position
	Spark at end of plug wire	No spark		Electrical problem
Spark at plug	Interlock switch		Incorrect gap - Covered with carbon - Fouled with fuel - Plug defective	Adjust to 0.65mm (0.026 in.) Clean or replace plug

ENGINE PROBLEM TROUBLESHOOTING CHART				
Problem	Check	Status	Cause	Remedy
Engine runs, but dies or Engine does not accelerate properly	Air filter	Air filter dirty	Normal wear	Clean or replace
	Fuel filter	Fuel filter dirty	Contaminants or residue in fuel	Replace filter or replace fuel
	Fuel vent	Fuel vent plugged	Contaminated fuel	Clean or replace
	Spark plug	Plug dirty or worn	Normal wear	Clean and adjust or replace
	Carburetor	Improper adjustment	Vibration	Adjust
	Cooling system	Cooling system dirty or plugged	Extended operation in dirty or dusty locations	Clean
	Spark arrestor screen	Spark arrestor screen plugged	Normal wear	Replace
Engine does not crank	N/A		Internal engine problem	See your dealer

STORAGE

WARNING

During operation the muffler or catalytic muffler and surrounding cover become hot. Always keep exhaust area clear of flammable debris during transportation or when storing, otherwise serious property damage or personal injury may result.

Long Term Storage (Over 30 Days)

Do not store your unit for a prolonged period of time (30 days or longer) without performing protective storage maintenance which includes the following:

1. Store unit in a dry, dust free place, out of the reach of children.

DANGER

Do not store in enclosure where fuel fumes may accumulate or reach an open flame or spark.

2. Place the stop switch or lever in the "OFF" position.
3. Remove accumulation of grease, oil, dirt and debris from exterior of unit.
4. Perform all periodic lubrication and services that are required.
5. Tighten all the screws and nuts.
6. Drain fuel tank completely. Press purge bulb 6 -7 times to remove remaining fuel from carburetor then drain the tank again. Close choke, start and run the engine until it stops due to lack of fuel.
7. Allow engine to cool. Remove the spark plug lead from the spark plug. Remove the spark plug. Pour 7 cc (0.25 oz.) of fresh, clean, two-stroke engine oil into the cylinder through the spark plug hole.
8. Pull the recoil starter handle 2-3 times to distribute the oil inside the engine.
9. Observe the piston location through the spark plug hole. Pull the recoil handle slowly until the piston reaches the top of its travel and leave it there.
10. Install the spark plug. Connect the spark plug lead to the spark plug.
11. Remove blower pipe assembly from unit.

SPECIFICATIONS

MODEL	EB600RT
Length (w/o pipes)	379 mm (14.92in.)
Width (w/o pipes)	478 mm (18.82 in.)
Height (w/o pipes)	459 mm (18.07 in.)
Weight (dry) (w/o pipes)	10.3 kg (22.7 lb.)
Engine Type	Air cooled, two-stroke, single cylinder gasoline engine
Bore	46.0 mm (1.81 in.)
Stroke	35.0 mm (1.38 in.)
Displacement	58.2 cc (3.55 cu. in.)
Exhaust	Spark arrestor muffler or spark arrestor muffler with catalyst
Carburetor	Diaphragm w/purge pump
Ignition System	Flywheel magneto, capacitor discharge ignition type
Spark Plug	NGK BPMR8Y (Gap 0.65 mm [0.026 in.])
Fuel	Mixed (Gasoline and Two-stroke Oil)
Gasoline/Oil Ratio	50:1
Gasoline	Use 89 Octane unleaded. Do not use fuel containing methyl alcohol, more than 10% ethyl alcohol or 15% MTBE. Do not use alternative fuels such as E-15 or E-85.
Oil	ISO-L-EGD (ISO/CD 13738) and J.A.S.O. M345- ED, two-stroke, air-cooled engine oil.
Fuel Tank Capacity	1.83 L (62 US fl. oz.)
Starter System	Automatic Recoil Starter, centrifugal type
Idle Speed	2,700 RPM
Wide Open Throttle Speed (W.O.T.)	6,550 RPM
Average Air Speed w/pipes	80.5 m/sec (180mph)
Maximum Air Speed w/pipes	96.4 m/sec (216 mph)
Air Volume	14.7 m ³ /min. (517 cu. ft./min.)
Sound Level at 50 ft. dB(A) scale per ANSI B175.2	70 dB(A)

NOTES

PRODUCT REGISTRATION

Thank you for choosing Shindaiwa Power Equipment

Please go to <http://www.shindaiwa-usa.com> to register your new product online. It's **FAST** and **EASY!** NOTE: your information will never be sold or misused by ECHO, Inc. Registering your purchase enables us to contact you in the unlikely event of a service update or product recall, and verifies your ownership for warranty consideration.

If you do not have access to the Internet, you can complete the form below and mail to:

ECHO Inc., Product Registration, PO Box 1139, Lake Zurich IL 60047.



PRODUCT REGISTRATION CARD : TARJETA DE REGISTRO : CARTE D'ENREGISTREMENT DU PRODUIT

ONLINE OPTION: Register online and save a stamp! You will be alerted of product updates and/or be sent new Shindaiwa product information and special offers. Simply go to: www.shindaiwa-usa.com

OPCIÓN POR INTERNET: Regístrese en la página web y ahorre una estampilla. Le alertarán sobre actualizaciones del producto y/o se le enviara información sobre los nuevos productos Shindaiwa y las ofertas especiales. Simplemente visite: www.shindaiwa-usa.com

OPTION EN LIGNE: Enregistrez en ligne et épargnez un timbre. Vous serez alerté(e) des mises à jour de produits ainsi que les offres spéciales. Simplement visitez le: www.shindaiwa-usa.com

Please Print : Por Favor Enscriba Con Letra De Molde : En Lettre Carré S.V.P.

Confidential: Information provided will not be shared or sold

Purchaser's Name : Nombre del Comprador : Nom de l'acheteur	
Address : Dirección : Adresse	
City : Ciudad : Ville	State : Estado : Province
Zip Code : Código Postal : Code Postal	
E-Mail Address : Dirección De Correo Electrónico : Courrier Electronique	
Phone Number : Número De Teléfono : Téléphone	Date of Purchase : Fecha de la Compra : Date de l'achat
Where Purchased : Nombre del Almacén donde fue Comprado : Lieu d'achat	
Model Number : Número del Modelo : No. de modèle	Serial Number : Número de Serie : No. de série

Registering your purchase enables us to contact you in the unlikely event of a service update or product recall and verifies your ownership in the event of loss. El registrar su compra nos permite estar en contacto con usted en caso de cualquier evento de actualización de servicio o de llamado de atención de un producto. El registro de su compra también verifica su propiedad y le permite contactar con nosotros en caso de cualquier actualización de servicio o de llamado de atención de un producto. L'enregistrement de votre achat nous permettra de vous contacter dans le cas improbable de modifications des instructions d'entretien ou de rappel du produit et vérifier que vous êtes le propriétaire en cas de vol ou de perte.

Primary use of tool: Professional Homeowner Rental Equip.
 Uso primario de la herramienta: Profesional Dueño de casa Alquiler
 Usage principal: Profesional Residencial Location
 Do you wish to receive periodic Shindaiwa product information and special offers by e-mail? Yes No
 ¿Desea usted recibir información periódica y ofertas especiales por correo electrónico sobre el producto Shindaiwa? Yes No
 Souhaitez-vous recevoir périodiquement de l'information sur les produits Shindaiwa et les offres spéciales par courrier électronique ? Oui Non
 Did you visit the Shindaiwa website before purchasing your product? Yes No
 ¿Si No
 Visito usted la página web Shindaiwa antes de comprar su producto? Si No
 Avez-vous visité le site d'Shindaiwa avant de procurer votre produit? Oui Non

What factor(s) most influenced your purchase?
 Performance Dealer
 Reliability Price Quality
 Friend/Family Brand Warranty
 ¿Qué factor(es) influenció más en su compra?
 Funcionamiento Precio Distribuidor
 Confiablez Calidad Garantía
 Amigo/Familia Marca Garantía
 Quel facteur (facteurs) vous a influencé le plus?
 Performance Prix Marchand
 Fiabilité Expérience Qualité
 Ami/Famille Garantie

1.877.966.7783 www.shindaiwa-usa.com X7571120102 02-2012



P45214003845 - P45214999999

P48514001001 - P48514999999

shindaiwa[®]

ECHO INCORPORATED

400 Oakwood Road

Lake Zurich, IL 60047

www.shindaiwa-usa.com