

USE AND CARE GUIDE

44 IN. OUTDOOR FIRE RING

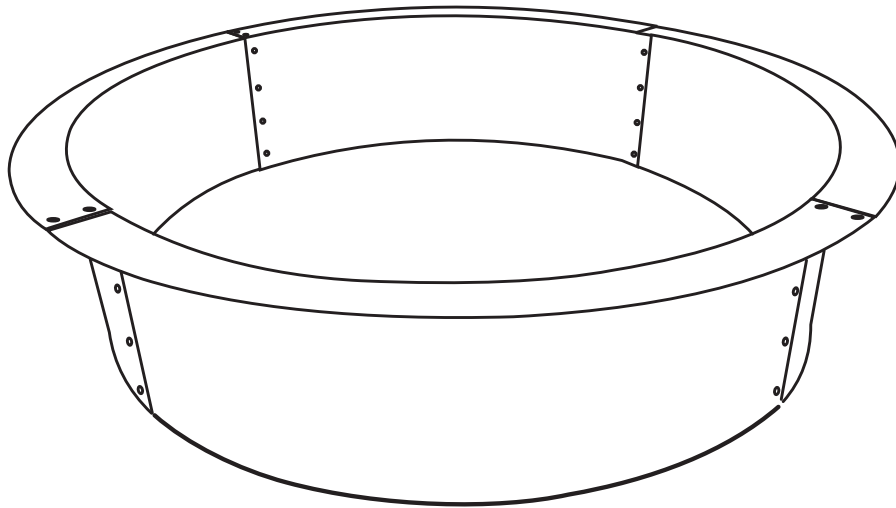

Questions, problems, missing parts?
Before returning to the store, call Customer Service
8 a.m. - 5 p.m., EST, Monday-Friday

1-877-527-0313

HOMEDEPOT.COM

Table of Contents









Table of Contents.....2
 Safety Information.....2
 Precautions.....2
 Warranty.....3
 Pre-Assembly.....3
 Planning Assembly.....3
 Tools Rrequired.....3
 Hardware Included.....3
 Package Contents.....4













Assembly.....5
 Care and Cleaning.....6

Safety Information

PRECAUTIONS

Use caution and common sense when using your outdoor fireplace. Failure to adhere to the safety warnings and guidelines in this manual could result in bodily injury or property damage. Save this manual for future reference.

-  **DANGER:** To prevent personal injury, burns, property damage, or even death, carefully monitor all activity and alert all persons in the vicinity of burning outdoor fireplaces of the dangers and safety precautions associated with open flame fireplaces. Do not use outdoor fireplaces where alcoholic beverages are being consumed.
-  **DANGER:** Keep children, pets, loose clothing, and hair safely away from the outdoor fireplace. Failure to adhere to this could lead to severe personal injury or possible death. Do not allow children to use or play near this outdoor fireplace.
-  **DANGER:** Do not use indoors due to the hazard of carbon monoxide fumes and fire. Lack of ventilation may cause death.
-  **WARNING:** For outdoor use only.
-  **WARNING:** Outdoor fireplaces are only to be used in a well ventilated area a minimum of 20 ft. from building walls, overhangs, trees, and so forth to prevent fires or melting of materials from buildings.
-  **WARNING:** Do not place the outdoor fireplace where flames could ignite combustible materials such as roof overhangs, wooden structures, fuel, clothing, fabric, or dry vegetation.
-  **WARNING:** To avoid fire hazards, never leave a burning outdoor fireplace unattended. If you must leave the area of the fire pit, ensure that all fire embers are extinguished.
-  **WARNING:** Never use gasoline, kerosene, alcohol, or other flammable fuel in or around the outdoor fireplace. Do not use the outdoor fireplace near gasoline or other flammable liquids, gases, or where flammable vapors may be present.

-  **WARNING:** Place the outdoor fireplace out of the way of pedestrian traffic, trees, and tree branches.
-  **WARNING:** Use with extreme care and at your own risk.
-  **WARNING:** The metal surface can get very hot and caution must be used when handling the fireplace after use. Never move the outdoor fireplace when in use or immediately after use when it may be hot.
-  **WARNING:** Do not touch the flame or outdoor fireplace when in use.
-  **WARNING:** Do not use during windy conditions.
-  **WARNING:** Please check with your local fire municipality or authority on any restrictions of use.
-  **WARNING:** Do not overload the bowl beyond 6 to 8 pounds.
-  **WARNING:** Place the outdoor fireplace on firm, level ground or surfaces free of debris. Do not use on wooden or composite decks.
-  **WARNING:** It is advised that a fire extinguisher be readily available. Refer to your local authority to determine the proper size of the fire extinguisher.
-  **WARNING:** Do not use the outdoor fireplace for other than its intended purpose.
-  **WARNING:** Do not attempt to service or modify the fireplace other than normal maintenance procedures as explained in the Care and Cleaning section of this manual.
-  **WARNING:** Metal surfaces will become extremely hot during use. Always use caution when handling a spark screen and a screen lifting tool, if equipped. Failure to wear flame retardant, protective gloves while handling steel parts may lead to serious burns and injury.

Warranty

This product carries no warranty. No replacement parts are available.

If there are any questions, contact the Customer Service Team at 1-877-527-0313 or visit www.homedepot.com

Pre-Assembly

PLANNING ASSEMBLY

Read all safety warnings and instructions carefully and thoroughly before assembling and operating your outdoor fireplace. Familiarize yourself with the inventory of parts and the accompanying illustrations to ensure safe and proper assembly. The manufacturer is not responsible for any injury that may occur during the assembly of this product.

Place the parts on a soft surface to assemble and prevent scratching the finish.

TOOLS REQUIRED (NOT INCLUDED)

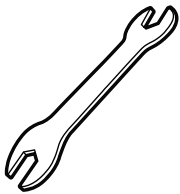

17 mm
Wrench

HARDWARE INCLUDED



NOTE: Hardware not shown to actual size.



AA



BB



CC

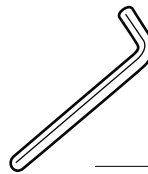

DD

Part	Description	Quantity
AA	M6 x 15 bolt	8
BB	M10 x 20 bolt	16
CC	M6 nut	1
DD	Allen Key	1

Pre-Assembly (continued)

PACKAGE CONTENTS

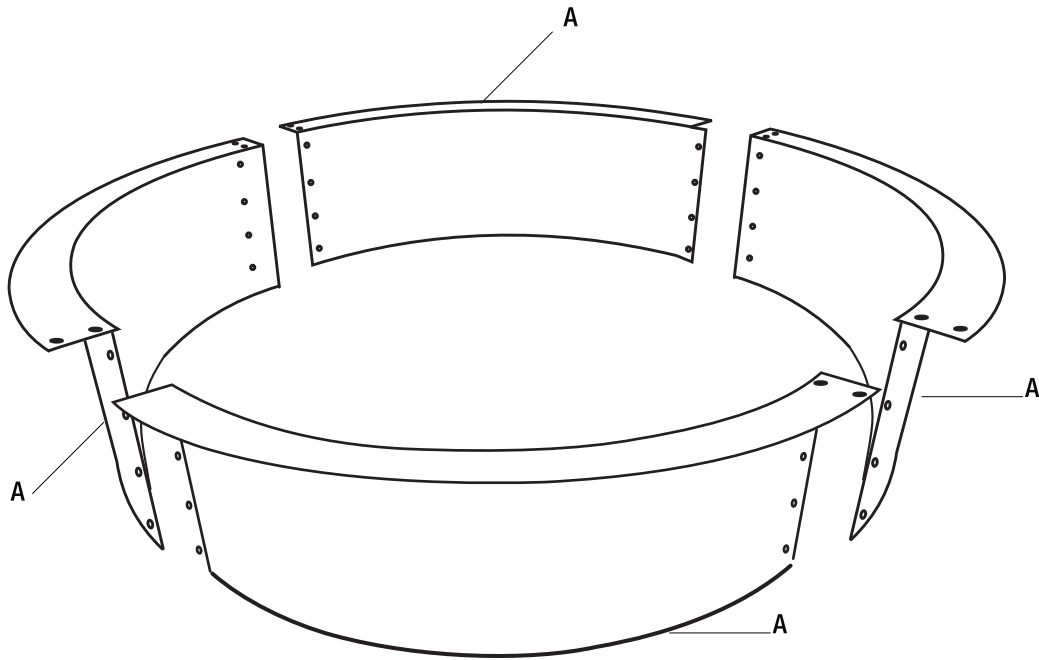

Part	Description	Quantity
A	Fire ring sections	4

Assembly

1 Assembling the first two ring sections

- Align the bolt holes of two of the fire ring sections (A).
- Insert bolts (BB) through the holes of wall of both sections (A) and loosely secure with nuts (CC).
- Loosely secure with the bolt (AA) through the top edge of both sections (A).

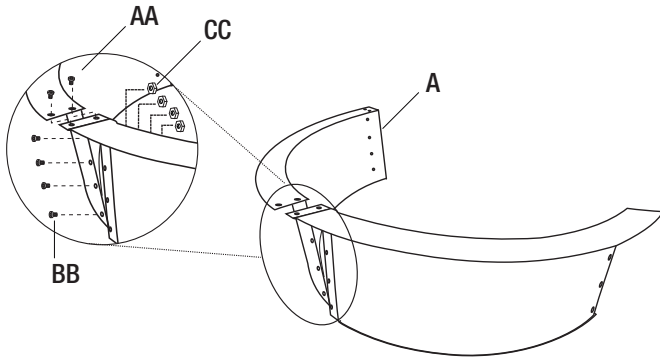

2 Assembling the third ring section

- Align the holes of the third ring section (A) with the ring assembly and attach using bolts (BB) and nuts (CC). Do not over tighten the nuts (cc).
- Loosely secure with the bolt (AA) through the top edge of both sections (A).

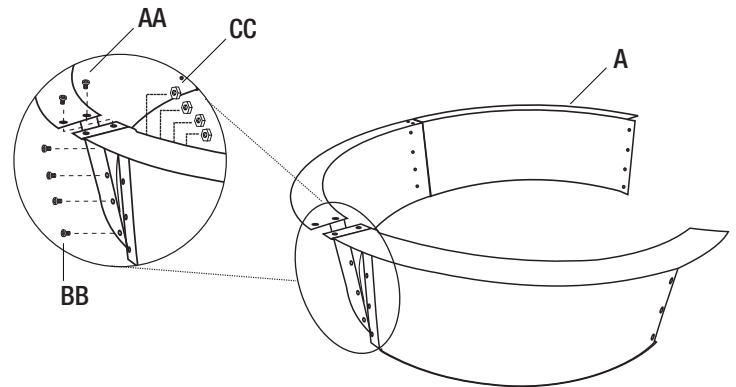

3 Attaching the final ring section

- Align the holes of the fourth ring section (A) with the ring assembly and attach using bolts (BB) and nuts (CC). Do not over tighten the nuts (CC).
- Loosely secure with the bolt (AA) through the top edge of both sections (A).

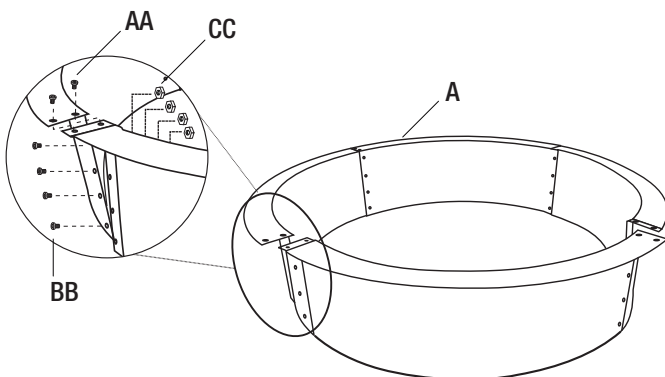

4 Completing the assembly

- Align the holes of the fourth ring section (A) with the first ring section (A) and secure together using bolts (BB) and nuts (CC).
- Loosely secure with the bolt (AA) through the top edge of both sections (A).
- Tighten all of the nuts (CC) with a wrench (not included).
- Tighten all of the bolts (AA) with an allen key (DD).

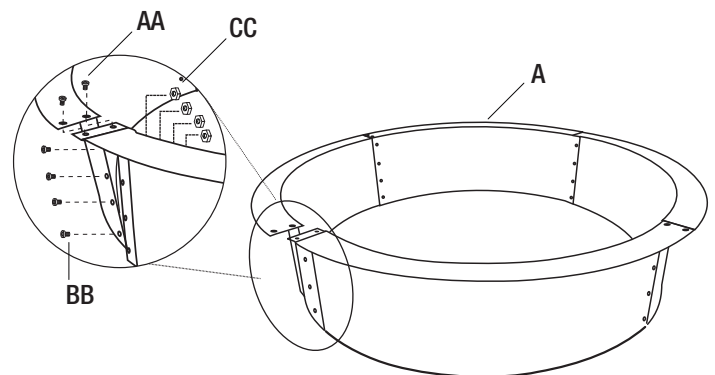

Care and Cleaning

- ❑ Once the fireplace is completely cooled down, pour the ashes from the fire ring and rinse with clean water and allow to dry completely.
- ❑ Clean after each use.
- ❑ Do not use a scrub brush.
- ❑ If the paint chips, use only high-temperature paints and a brush to fix.
- ❑ If rust is showing, sand lightly and repaint the area with high-temperature paints.
- ❑ Dry with a soft cloth.
- ❑ Cover the unit when not in use to prolong the life.
- ❑ Keep your fire ring out of rain.

**Questions, problems, missing parts? Before returning to the store call
Hampton Bay Customer Service
8 a.m. - 6 p.m., EST, Monday-Friday**

1-877-527-0313

HOMEDEPOT.COM

**Handcrafted by artisans in India
Retain this manual for future use.**