



TRILINK

CATALOG | APPLICATION GUIDE

www.trilinksawchain.com

TRILINK
Saw Chain

YOUR LINK TO QUALITY

At TriLink Saw Chain we believe that quality is the key to success. Our guide bar and saw chain factory is ISO 9001:2000 certified. This certification gives our customers the confidence that they are buying from a company that is committed to providing quality products and services.



TriLink Saw Chain also offers a complete line of professional saw chain as well as low kickback saw chain that has been tested, approved, and listed by Underwriter's Laboratories to meet all standards for low kickback chain in accordance with the American National Standard Safety Requirements (ANSI B175.1) for gasoline powered chain saws. Our manufacturing facilities are audited quarterly by Underwriter's Laboratories to maintain this listing and your confidence in our products.



CHAIN BASICS 4-7

DESIGN FEATURES 8-9

SAW CHAIN PACKAGING and PART NUMBERS 10-11

TABLE OF CONTENTS

BULK CHAIN 12-13

SEMI CHISEL CHAIN 14-17

FULL CHISEL CHAIN 18-19

DRIVE LINK FOOTAGE 20-21

SAW CHAIN CONVERSION CHART 22

GUIDE BAR PART NUMBERS 23

GUIDE BAR LISTING and CONVERSION CHART 24-34

GUIDE BAR MOUNT APPLICATIONS 35-47

GUIDE BAR and CHAIN APPLICATIONS 48-67

GUIDE BAR MOUNTS 68-75

CUTTING ACCESSORIES 76-82

REPLACEMENT SPROCKETS 83-93

NOTES 94-95



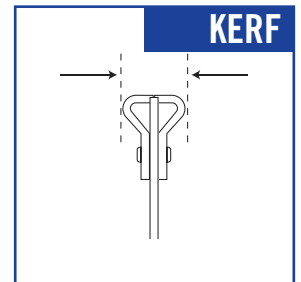
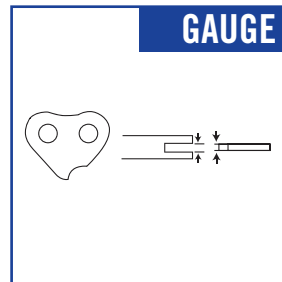
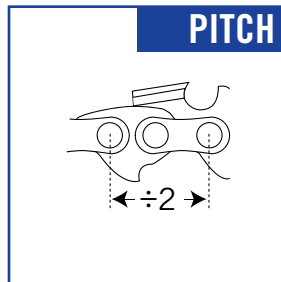

PITCH is determined by measuring the distance between the centers of any three consecutive rivets and dividing by two.

GAUGE of a chain is the thickness of the drive link measured at the tang. It's essential that the drive link thickness correctly matches the width of the groove in the guide bar.

KERF is the width of the cut in the wood made by the saw chain cutter. Optimum kerf for a saw chain is dependent on the chain saw's horsepower, saw chain speed, length of the guide bar and the size, hardness and type of timber being cut. TriLink® saw chain is available with the ideal kerf for every combination of equipment and timber.



CUTTER STYLES:



SEMI-CHISEL CUTTERS have a smaller radius than the Chipper Cutter's leading edge allowing it to stay sharper longer and cut faster in dirty and gritty cutting conditions. Ideal for consumer use.



FULL CHISEL CUTTERS are designed for fast, smooth cutting at high-speeds in clean conditions. The square cutter edge is specifically designed to reduce cutting friction for an extremely smooth, clean cut and fast chip clearance. Preferred by professional users.

SAW CHAIN SEQUENCES:

There are 3 different sequences of saw chain:

FULL COMPLEMENT CHAIN: One tie strap between each cutter



SEMI SKIP: Chain pattern alternates one tie strap and two tie straps between each cutter



Full Skip: Chain has two tie straps between each cutter (half the cutting teeth of full complement chain)



SAFETY SAW CHAIN

TriLink® safety saw chain incorporates ramped depth gauges to allow smooth high speed cutting while reducing kickback and vibration. All TriLink® safety saw chain is low kickback UL tested and UL approved.



BUMPER LINK [SAFETY DRIVE LINK]

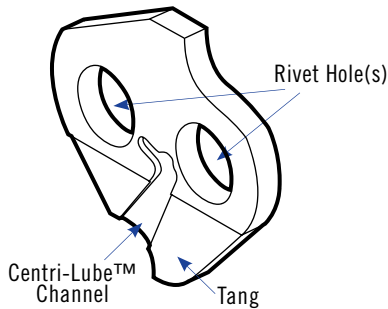

TIE STRAP

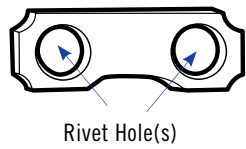

CUTTER TOOTH

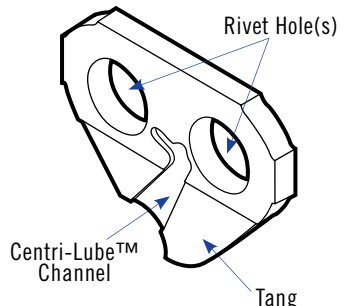
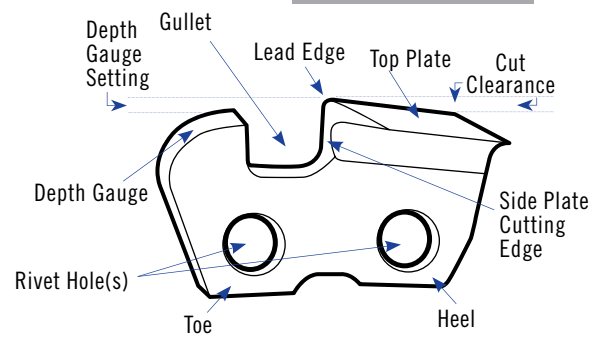

DRIVE LINK

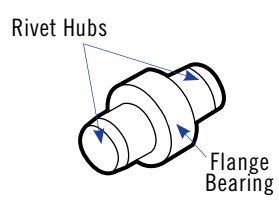

RIVET

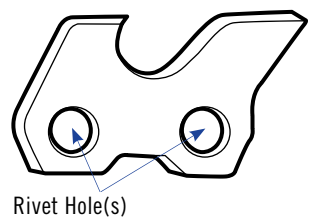

GUARD LINK [SAFETY TIE STRAP]



GUARD LINK SAFETY SAW CHAIN



TIE STRAP

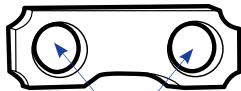

Rivet Hole(s)

CUTTER TOOTH

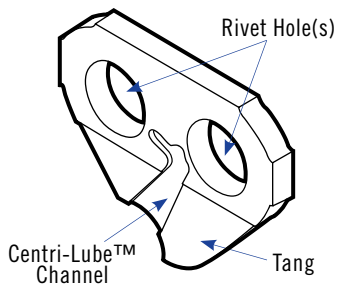
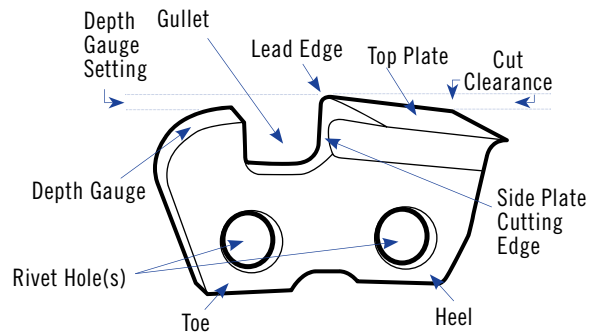

DRIVE LINK

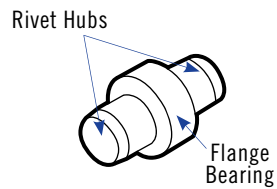

RIVET



PROFESSIONAL SAW CHAIN

TriLink® professional saw chain is designed specifically for professional cutters. Professional saw chains are engineered for fast, smooth cutting at high speeds in clean cutting conditions.

Lubrication is the key element in maintaining and extending the life of your chain and guide bar. Lack of proper lubrication develops friction between chain components and the guide bar. This results in decreased cutting performance, lower chain life, and increased stress on engine and drive components. Increased lubrication along the bar and between chain components will increase the life of the chain and provide better cutting performance.

CENTRI  **LUBE™** chain has a specially designed channel in each drive link that picks up oil from the bar and distributes it to the rivets reducing friction and increasing saw chain life.

In an effort to enhance cutting performance and chain life, TriLink® Saw Chain has introduced our Centri-Lube™ Oiling System. Centri-Lube™ saw chain has a specially designed channel in each drive link that picks up oil from the bar and distributes it to the rivets that act as bearings on a chain. As the chain travels around the bar tip and drive sprocket, centrifugal force moves the oil up this channel and distributes it to the rivets in each link. This reduces friction and heat build-up in the chain and guide bar thereby increasing cutting performance and chain life. Your chain lasts longer and the job is done faster.

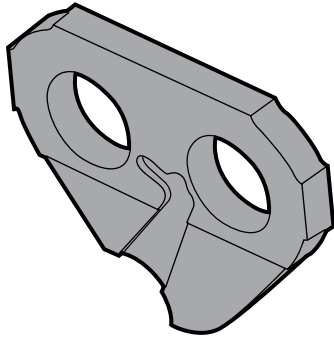

- TriLink® saw chain is available in 25 ft. reels, 100 ft. reels, and pre-cut loops
- When ordering bulk chain in 25 ft. or 100 ft. sizes, please specify the pitch, gauge and chain type number
- For loops, please also include the drive link count
- All reels include presets and tie straps

BETTER LUBRICATION INCREASES THE LIFE OF YOUR CHAIN AND IT'S CUTTING PERFORMANCE

- Manufactured to exacting standards of quality, strength and durability
- Chromed cutters for longer life and a sharper edge
- Engineered for precision, balance and low vibration
- UL listed chains meet all ANSI standards for low kickback chain

TriLink Saw Chain™ offers a full line of saw chain available in both individual chain loops and bulk reels.

TriLink® saw chain individual chain loops are offered in a wide range of packaging options. All retail chains are packed with full color inserts, an instruction sheet, and can be heat sealed to reduce pilferage or remain resealable for chain comparison. The exception is the poly bagged product which will be labeled with an item description and part number. Poly bagged product will not include instruction sheets.



BULK REELS

STANDARD DIMENSIONS: 8.63" L x 8.88" W x 8.63" H 8.63" L x 8.88" W x 5.63" H
 220mm L x 225mm W x 220mm H 220mm L x 225mm W x 143mm H

- Available in 100 ft. and 25 ft. reels
- Full Color Box Artwork
- Includes joining kits and loop boxes for repackaging



CHAIN LOOP BOXES

STANDARD DIMENSIONS: 3.35" L x 1.38" W x 5.52" H 4.02" L x 1.38" W x 7.05" H
 85mm L x 35mm W x 140mm H 102mm L x 35mm W x 179mm H

- Full Color Box Artwork
- Resealable
- Includes saw chain instruction sheet



UNIVERSAL CLAMSHELLS

STANDARD DIMENSIONS: 4.13" L x 1.13" W x 7.50" H
 105mm L x 29mm W x 191mm H

- Full Color Insert
- Heat Sealed or Resealable
- Includes saw chain instruction sheet
- Shipped in PDQs of 5 Pieces



ZIP PACKS

STANDARD DIMENSIONS: 2.63" L x 1.38" W x 7.75" H
 67mm L x 35mm W x 197mm H

- Full Color Sticker Labels
- Resealable
- Includes saw chain instruction sheet
- Shipped in PDQs of 5 Pieces



READING THE TRILINK PART NUMBER

Saw Chain Numbering System

Example Part Number:

CL 2 58 (BR100)56 X* (BL)NS TL**

Centri-Lube™ Indicator

If included indicates Centri-Lube™ Chain

Chain Pitch

1 = 3/8" LP Semi-Chisel
 2 = .325" Semi-Chisel
 3 = 3/8" Std. Semi-Chisel
 4 = .404" Semi-Chisel
 6 = 3/8" LP Chisel
 7 = .325" Chisel
 8 = 3/8" Std. Chisel
 9 = .404" Chisel

Chain Gauge

43 = .043"
 50 = .050"
 58 = .058"
 63 = .063"
 80 = .080"

Chain Length

Loop Chain:
Drive Link Count
 56 = 56 Links

Bulk Reel Chain:
Footage Count
 BR100 = 100 Ft.
 BR25 = 25 Ft.

Chain Sequence*

X = Full Skip
 Y = Semi Skip

If nothing listed then chain is standard sequence

Non-Safety Indicator**

If included indicates Professional Non-Safety Low Kickback Chain

Brand

TL = TriLink®

*will not be included in the part number for standard chains

**3/8" STD with bumper links will have "BL" before "NS" in the part number

Saw Chain Stamping Codes

SEMI-CHISEL	CHISEL
1A = 3/8" LP, .043"	
1B = 3/8" LP, .050"	
2B = .325", .050"	7B = .325", .050"
2C = .325", .058"	7C = .325", .058"
2D = .325", .063"	7D = .325", .063"
3B = 3/8", .050"	8B = 3/8", .050"
3C = 3/8", .058"	8C = 3/8", .058"
3D = 3/8", .063"	8D = 3/8", .063"
4C = .404", .058"	
4D = .404", .063"	
4E = .404", .080"	



BULK REEL CHAIN PACKAGING

TriLink® saw chain bulk reel chains can be packaged in footage rolls of either 25 foot or 100 foot lengths. Each reel comes with a full color outer box with an inner spool and includes individual chain boxes and joining links.

Each **100** foot roll comes with **30** joining kits and **30** chain loop boxes.

Each **25** foot roll comes with **10** Joining kits and **10** chain loop boxes.



25FT. REELS BULK CHAIN FULL CHISEL

PART NO.	DESCRIPTION
CL750BR25TL	.325" - .050"
CL750BR25NSTL	.325" - .050"
CL758BR25TL	.325" - .058"
CL758BR25NSTL	.325" - .058"
CL763BR25TL	.325" - .063"
CL763BR25NSTL	.325" - .063"
CL850BR25TL	3/8" - .050"
CL850BR25NSTL	3/8" - .050"
CL850BR25BLNSTL	3/8" - .050"
CL858BR25TL	3/8" - .058"
CL858BR25NSTL	3/8" - .058"
CL858BR25BLNSTL	3/8" - .058"
CL863BR25TL	3/8" - .063"
CL863BR25NSTL	3/8" - .063"
CL863BR25BLNSTL	3/8" - .063"

25FT. REELS BULK CHAIN SEMI-CHISEL

PART NO.	DESCRIPTION
CL143BR25TL	3/8" LP - .043"
CL143BR25NSTL	3/8" LP - .043"
CL150BR25TL	3/8" LP - .050"
CL150BR25NSTL	3/8" LP - .050"
CL250BR25TL	.325" - .050"
CL250BR25NSTL	.325" - .050"
CL258BR25TL	.325" - .058"
CL258BR25NSTL	.325" - .058"
CL263BR25TL	.325" - .063"
CL263BR25NSTL	.325" - .063"
CL350BR25TL	3/8" - .050"
CL350BR25NSTL	3/8" - .050"
CL350BR25BLNSTL	3/8" - .050"
CL358BR25TL	3/8" - .058"
CL358BR25NSTL	3/8" - .058"
CL358BR25BLNSTL	3/8" - .058"
CL363BR25TL	3/8" - .063"
CL363BR25NSTL	3/8" - .063"
CL363BR25BLNSTL	3/8" - .063"
458BR25TL	.404" - .058"
458NR25NSTL	.404" - .058"
463BR25TL	.404" - .063"
463BR25NSTL	.404" - .063"

JOINING KITS (10/bag)

PART NO.	DESCRIPTION
143JK10TL	3/8" LP - .043"
150JK10TL	3/8" LP - .050"
250JK10TL	.325" - .050"
258JK10TL	.325" - .058"
263JK10TL	.325" - .063"
350JK10TL	3/8" - .050"
358JK10TL	3/8" - .058"
363JK10TL	3/8" - .063"
458JK10TL	.404" - .058"
463JK10TL	.404" - .063"
750JK10TL	.325" - .050"
758JK10TL	.325" - .058"
763JK10TL	.325" - .063"
850JK10TL	3/8" - .050"
858JK10TL	3/8" - .058"
863JK10TL	3/8" - .063"

100FT. REELS BULK CHAIN SEMI-CHISEL

PART NO.	DESCRIPTION
CL143BR100TL	3/8" LP - .043"
CL143BR100NSTL	3/8" LP - .043"
CL150BR100TL	3/8" LP - .050"
CL150BR100NSTL	3/8" LP - .050"
CL250BR100TL	.325" - .050"
CL250BR100NSTL	.325" - .050"
CL258BR100TL	.325" - .058"
CL258BR100NSTL	.325" - .058"
CL263BR100TL	.325" - .063"
CL263BR100NSTL	.325" - .063"
CL350BR100TL	3/8" - .050"
CL350BR100NSTL	3/8" - .050"
CL350BR100BLNSTL	3/8" - .050"
CL358BR100TL	3/8" - .058"
CL358BR100NSTL	3/8" - .058"
CL358BR100BLNSTL	3/8" - .058"
CL363BR100TL	3/8" - .063"
CL363BR100NSTL	3/8" - .063"
CL363BR100BLNSTL	3/8" - .063"
458BR100TL	.404" - .058"
458NR100NSTL	.404" - .058"
463BR100TL	.404" - .063"
463BR100NSTL	.404" - .063"

100FT. REELS BULK CHAIN FULL CHISEL

PART NO.	DESCRIPTION
CL750BR100TL	.325" - .050"
CL750BR100NSTL	.325" - .050"
CL758BR100TL	.325" - .058"
CL758BR100NSTL	.325" - .058"
CL763BR100TL	.325" - .063"
CL763BR100NSTL	.325" - .063"
CL850BR100TL	3/8" - .050"
CL850BR100NSTL	3/8" - .050"
CL850BR100BLNSTL	3/8" - .050"
CL858BR100TL	3/8" - .058"
CL858BR100NSTL	3/8" - .058"
CL858BR100BLNSTL	3/8" - .058"
CL863BR100TL	3/8" - .063"
CL863BR100NSTL	3/8" - .063"
CL863BR100BLNSTL	3/8" - .063"



TriLink Saw Chain™ semi chisel chains incorporate the semi chisel cutter that cuts faster and stays sharper longer in dirty and gritty cutting conditions.



TriLink saw chains are engineered for precision, balance and low vibration. All chains are manufactured with advanced heat treatment and hard chrome to allow for improved cutter performance.

3/8" LP

3/8" LP Semi Chisel w/ Bumper Link



STYLE NO.	PITCH	GAUGE	FILE	GRINDING ANGLE	DEPTH GAUGE
CL143TL	3/8" LP	.043"	5/32"	30°	.022"
CL150TL	3/8" LP	.050"	5/32"	30°	.022"

- Ramped depth gauges allows smooth high speed cutting while reducing kickback and vibration
- Safety chain meets all standards for ANSI Low Kickback chain
- Recommended for saws up to 40 cc

LOWKICKBACK SAW CHAIN: The chain in this package is a low-kickback chain. It met the kickback performance requirements ANSI B175.1-2012, paragraph 5.11.2.4, and CSA Z62.3 and significantly reduces the hazard of chain saw kickback when tested on a representative sample of chainsaws.

CHAÎNE DE SCIE À FAIBLE REBOND: Il s'agit d'une chaîne à faible rebond conforme aux normes de performances ANSI B175.1-2012, paragraphe 5.11.2.4, and CSA Z62.3 relatives aux rebonds qui réduit de manière significative le danger de rebond de la tronçonneuse lorsque testé sur un échantillon représentatif de scies à chaîne.

CADENA PARA MOTOSIERRA DE BAJO REBOTE: Esta es una cadena de bajo rebote y cumple con los requisitos de rendimiento en caso de rebote de las normas ANSI B175.1-2012, párrafo 5.11.2.4, y CSA Z62.3. También reduce significativamente el peligro de rebote de la motosierra al someterse a pruebas en una muestra representativa de motosierras.

3/8" LP

3/8" LP Semi Chisel Professional

PRO

STYLE NO.	PITCH	GAUGE	FILE	GRINDING ANGLE	DEPTH GAUGE
CL143NSTL	3/8" LP	.043"	5/32"	30°	.022"
CL150NSTL	3/8" LP	.050"	5/32"	30°	.022"

- Recommended for saws up to 40 cc

.325" Semi Chisel w/ Bumper Link



.325"

STYLE NO.	PITCH	GAUGE	FILE	GRINDING ANGLE	DEPTH GAUGE
CL250TL	.325"	.050"	3/16"	30°	.022"
CL258TL	.325"	.058"	3/16"	30°	.022"
CL263TL	.325"	.063"	3/16"	30°	.022"

- Ramped depth gauges allows smooth high speed cutting while reducing kickback and vibration
- Safety chain meets all standards for ANSI Low Kickback chain
- Recommended for saws up to 40 cc - 60 cc



LOWKICKBACK SAW CHAIN: The chain in this package is a low-kickback chain. It met the kickback performance requirements ANSI B175.1-2012, paragraph 5.11.2.4, and CSA Z62.3 and significantly reduces the hazard of chain saw kickback when tested on a representative sample of chainsaws.

CHAÎNE DE SCIE À FAIBLE REBOND: Il s'agit d'une chaîne à faible rebond conforme aux normes de performances ANSI B175.1-2012, paragraphe 5.11.2.4, and CSA Z62.3 relatives aux rebonds qui réduit de manière significative le danger de rebond de la tronçonneuse lorsque testé sur un échantillon représentatif de scies à chaîne.

CADENA PARA MOTOSIERRA DE BAJO REBOTE: Esta es una cadena de bajo rebote y cumple con los requisitos de rendimiento en caso de rebote de las normas ANSI B175.1-2012, párrafo 5.11.2.4, y CSA Z62.3. También reduce significativamente el peligro de rebote de la motosierra al someterse a pruebas en una muestra representativa de motosierras.

.325" Semi Chisel Professional



.325"

STYLE NO.	PITCH	GAUGE	FILE	GRINDING ANGLE	DEPTH GAUGE
CL250NSTL	.325"	.050"	3/16"	30°	.022"
CL258NSTL	.325"	.058"	3/16"	30°	.022"
CL263NSTL	.325"	.063"	3/16"	30°	.022"

- Recommended for saws up to 40 cc - 60 cc





STYLE NO.	PITCH	GAUGE	FILE	GRINDING ANGLE	DEPTH GAUGE
CL350TL	3/8"	.050"	7/32"	30°	.028"
CL358TL	3/8"	.058"	7/32"	30°	.028"
CL363TL	3/8"	.063"	7/32"	30°	.028"

- Ramped depth gauges allows smooth high speed cutting while reducing kickback and vibration
- Safety chain meets all standards for ANSI Low Kickback chain
- Recommended for saws up to 40 cc - 60 cc



CLASSIFIED
C UL US
28DX

LOWKICKBACK SAW CHAIN: The chain in this package is a low-kickback chain. It met the kickback performance requirements ANSI B175.1-2012, paragraph 5.11.2.4, and CSA Z62.3 and significantly reduces the hazard of chain saw kickback when tested on a representative sample of chainsaws.

CHAÎNE DE SCIE À FAIBLE REBOND: Il s'agit d'une chaîne à faible rebond conforme aux normes de performances ANSI B175.1-2012, paragraphe 5.11.2.4, and CSA Z62.3 relatives aux rebonds qui réduit de manière significative le danger de rebond de la tronçonneuse lorsque testé sur un échantillon représentatif de scies à chaîne.

CADENA PARA MOTOSIERRA DE BAJA REBOTE: Esta es una cadena de bajo rebote y cumple con los requisitos de rendimiento en caso de rebote de las normas ANSI B175.1-2012, párrafo 5.11.2.4, y CSA Z62.3. También reduce significativamente el peligro de rebote de la motosierra al someterse a pruebas en una muestra representativa de motosierras.



STYLE NO.	PITCH	GAUGE	FILE	GRINDING ANGLE	DEPTH GAUGE
CL350BLNSTL	3/8"	.050"	7/32"	30°	.028"
CL358BLNSTL	3/8"	.058"	7/32"	30°	.028"
CL363BLNSTL	3/8"	.063"	7/32"	30°	.028"

- Recommended for saws up to 40 cc - 60 cc



3/8" Semi Chisel Professional



STYLE NO.	PITCH	GAUGE	FILE	GRINDING ANGLE	DEPTH GAUGE
CL350NSTL	3/8"	.050"	7/32"	30°	.028"
CL358NSTL	3/8"	.058"	7/32"	30°	.028"
CL363NSTL	3/8"	.063"	7/32"	30°	.028"

- Recommended for saws up to 40 cc - 60 cc

.404" Semi Chisel Professional



STYLE NO.	PITCH	GAUGE	FILE	GRINDING ANGLE	DEPTH GAUGE
458NSTL	.404"	.058"	7/32"	30°	.035"
463NSTL	.404"	.063"	7/32"	30°	.035"
480NSTL	.404"	.080"	7/32"	30°	.035"

- Recommended for saws over 70 cc
- .404" Machine Harvester available in .080" gauge item number 480NSTL





TriLink Saw Chain™ full chisel chains are designed specifically for the professional cutter.

TriLink® saw chains are engineered for fast, smooth cutting at high speeds in clean conditions. The square cutter edge is specifically designed to reduce cutting friction for an extremely smooth clean cut and fast chip clearance.

.325" Full Chisel w/ Bumper Link



STYLE NO.	PITCH	GAUGE	FILE	GRINDING ANGLE	DEPTH GAUGE
CL750TL	.325"	.050"	3/16"	30°	.028"
CL758TL	.325"	.058"	3/16"	30°	.028"
CL763TL	.325"	.063"	3/16"	30°	.028"

- Full chisel cutters engineered for fast, smooth cutting at high speeds
- Advanced heat treatment and hard chrome processes allow for improved cutter performance
- Safety chain meets all standards for ANSI Low Kickback chain



LOWKICKBACK SAW CHAIN: The chain in this package is a low-kickback chain. It met the kickback performance requirements ANSI B175.1-2012, paragraph 5.11.2.4, and CSA Z62.3 and significantly reduces the hazard of chain saw kickback when tested on a representative sample of chainsaws.

CHAÎNE DE SCIE À FAIBLE REBOND: Il s'agit d'une chaîne à faible rebond conforme aux normes de performances ANSI B175.1-2012, paragraphe 5.11.2.4, et CSA Z62.3 relatives aux rebonds qui réduit de manière significative le danger de rebond de la tronçonneuse lorsque testé sur un échantillon représentatif de soies à chaîne.

CADENA PARA MOTOSIERRA DE BAJO REBOTE: Esta es una cadena de bajo rebote y cumple con los requisitos de rendimiento en caso de rebote de las normas ANSI B175.1-2012, párrafo 5.11.2.4, y CSA Z62.3. También reduce significativamente el peligro de rebote de la motosierra al someterse a pruebas en una muestra representativa de motosierras.

.325" Full Chisel Professional



STYLE NO.	PITCH	GAUGE	FILE	GRINDING ANGLE	DEPTH GAUGE
CL750NSTL	.325"	.050"	3/16"	30°	.028"
CL758NSTL	.325"	.058"	3/16"	30°	.028"
CL763NSTL	.325"	.063"	3/16"	30°	.028"

- Full chisel cutters engineered for fast, smooth cutting at high speeds
- Advanced heat treatment and hard chrome processes allow for improved cutter performance



3/8" Full Chisel w/ Guard Link

3/8"



STYLE NO.	PITCH	GAUGE	FILE	GRINDING ANGLE	DEPTH GAUGE
CL850TL	3/8"	.050"	7/32"	30°	.028"
CL858TL	3/8"	.058"	7/32"	30°	.028"
CL863TL	3/8"	.063"	7/32"	30°	.028"

- Full chisel cutters engineered for fast, smooth cutting at high speeds
- Advanced heat treatment and hard chrome processes allow for improved cutter performance
- Safety chain meets all standards for ANSI Low Kickback chain

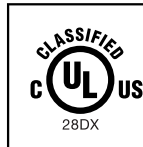

LOW KICKBACK SAW CHAIN: The chain in this package is a low-kickback chain. It met the kickback performance requirements ANSI B175.1-2012, paragraph 5.11.2.4, and CSA Z62.3 and significantly reduces the hazard of chain saw kickback when tested on a representative sample of chainsaws.

CHAÎNE DE SCIE À FAIBLE REBOND: Il s'agit d'une chaîne à faible rebond conforme aux normes de performances ANSI B175.1-2012, paragraphe 5.11.2.4, and CSA Z62.3 relatives aux rebonds qui réduit de manière significative le danger de rebond de la tronçonneuse lorsque testé sur un échantillon représentatif de scies à chaîne.

CADENA PARA MOTOSIERRA DE BAJO REBOTE: Esta es una cadena de bajo rebote y cumple con los requisitos de rendimiento en caso de rebote de las normas ANSI B175.1-2012, párrafo 5.11.2.4, y CSA Z62.3. También reduce significativamente el peligro de rebote de la motosierra al someterse a pruebas en una muestra representativa de motosierras.

3/8" Full Chisel Professional w/ Bumper Link

PRO

3/8"



STYLE NO.	PITCH	GAUGE	FILE	GRINDING ANGLE	DEPTH GAUGE
CL850BLNSTL	3/8"	.050"	7/32"	30°	.028"
CL858BLNSTL	3/8"	.058"	7/32"	30°	.028"
CL863BLNSTL	3/8"	.063"	7/32"	30°	.028"

- Full chisel cutters engineered for fast, smooth cutting at high speeds
- Advanced heat treatment and hard chrome processes allow for improved cutter performance

3/8" Full Chisel Professional

PRO

3/8"



STYLE NO.	PITCH	GAUGE	FILE	GRINDING ANGLE	DEPTH GAUGE
CL850NSTL	3/8"	.050"	7/32"	30°	.028"
CL858NSTL	3/8"	.058"	7/32"	30°	.028"
CL863NSTL	3/8"	.063"	7/32"	30°	.028"

- Full chisel cutters engineered for fast, smooth cutting at high speeds
- Advanced heat treatment and hard chrome processes allow for improved cutter performance

Drive link footage charts: saw chain loop footage and meter length based on our chain pitch and drive link counts.

3/8" LP Pitch

DRIVE LINKS	FEET	METERS
30	1.838	0,560
31	1.900	0,579
32	1.961	0,598
33	2.022	0,616
34	2.084	0,635
35	2.145	0,654
36	2.206	0,672
37	2.267	0,691
38	2.328	0,710
39	2.390	0,728
40	2.451	0,747
41	2.512	0,766
42	2.574	0,784
43	2.635	0,803
44	2.696	0,822
45	2.757	0,840
46	2.819	0,859
47	2.880	0,878
48	2.941	0,896
49	3.002	0,915
50	3.064	0,934
51	3.125	0,953
52	3.186	0,971
53	3.248	0,990
54	3.309	1,009
55	3.370	1,027
56	3.431	1,045
57	3.493	1,063
58	3.554	1,083
59	3.615	1,102
60	3.676	1,120
61	3.738	1,139
62	3.799	1,158
63	3.860	1,177
64	3.922	1,195
65	3.983	1,214
66	4.044	1,233
67	4.105	1,251
68	4.167	1,270
69	4.228	1,289
70	4.289	1,307
71	4.350	1,326
72	4.412	1,345
73	4.473	1,363
74	4.534	1,382
75	4.596	1,401
76	4.657	1,419
77	4.718	1,438
78	4.779	1,457
79	4.841	1,475
80	4.902	1,494

3/8" Pitch

DRIVE LINKS	FEET	METERS	DRIVE LINKS	FEET	METERS
40	2.457	0,747	81	4.964	1,513
41	2.513	0,766	82	5.025	1,532
42	2.574	0,785	83	5.087	1,550
43	2.635	0,803	84	5.148	1,569
44	2.696	0,822	85	5.209	1,588
45	2.758	0,841	86	5.270	1,606
46	2.819	0,859	87	5.352	1,625
47	2.880	0,878	88	5.393	1,644
48	2.942	0,897	89	5.454	1,662
49	3.003	0,915	90	5.516	1,681
50	3.064	0,934	91	5.577	1,700
51	3.125	0,953	92	5.638	1,718
52	3.187	0,971	93	5.699	1,737
53	3.248	0,990	94	5.761	1,756
54	3.309	1,005	95	5.822	1,775
55	3.371	1,027	96	5.883	1,793
56	3.432	1,046	97	5.944	1,812
57	3.493	1,065	98	6.006	1,831
58	3.554	1,083	99	6.067	1,849
59	3.616	1,102	100	6.128	1,868
60	3.676	1,120	101	6.190	1,887
61	3.738	1,139	102	6.251	1,905
62	3.800	1,158	103	6.312	1,924
63	3.861	1,177	104	6.373	1,943
64	3.922	1,195	105	6.435	1,961
65	3.983	1,214	106	6.496	1,980
66	4.045	1,233	107	6.557	1,999
67	4.106	1,252	108	6.619	2,017
68	4.167	1,270	109	6.680	2,036
69	4.229	1,289	110	6.741	2,055
70	4.290	1,308	111	6.802	2,073
71	4.350	1,326	112	6.864	2,092
72	4.412	1,345	113	6.925	2,111
73	4.474	1,364	114	6.986	2,129
74	4.535	1,382	115	7.048	2,148
75	4.596	1,401	116	7.109	2,167
76	4.658	1,420	117	7.170	2,185
77	4.719	1,438	118	7.231	2,204
78	4.780	1,457	119	7.293	2,223
79	4.841	1,476	120	7.354	2,242
80	4.903	1,494			

Bulk Chain Reels

PITCH	FEET	METERS	DRIVE LINKS	PITCH	FEET	METERS	DRIVE LINKS
3/8" LP	25	7,62	410	3/8" LP	100	30,48	1635
.325"	25	7,62	462	.325"	100	30,48	1840
3/8"	25	7,62	410	3/8"	100	30,48	1635
.404"	25	7,62	372	.404"	100	30,48	1480

.325" Pitch

DRIVE LINKS	FEET	METERS	DRIVE LINKS	FEET	METERS
40	2.165	0,660	81	4.383	1,336
41	2.219	0,676	82	4.438	1,353
42	2.273	0,693	83	4.492	1,369
43	2.327	0,709	84	4.546	1,386
44	2.381	0,726	85	4.600	1,402
45	2.435	0,742	86	4.654	1,419
46	2.489	0,759	87	4.708	1,435
47	2.543	0,775	88	4.762	1,452
48	2.597	0,792	89	4.816	1,468
49	2.652	0,808	90	4.871	1,485
50	2.706	0,825	91	4.925	1,501
51	2.760	0,841	92	4.979	1,518
52	2.814	0,858	93	5.033	1,534
53	2.868	0,874	94	5.087	1,551
54	2.922	0,891	95	5.141	1,567
55	2.976	0,907	96	5.195	1,583
56	3.030	0,924	97	5.249	1,600
57	3.084	0,940	98	5.303	1,616
58	3.139	0,957	99	5.358	1,633
59	3.193	0,973	100	5.412	1,649
60	3.247	0,990	101	5.466	1,666
61	3.301	1,006	102	5.520	1,682
62	3.355	1,023	103	5.574	1,699
63	3.409	1,039	104	5.628	1,715
64	3.463	1,056	105	5.682	1,732
65	3.517	1,072	106	5.736	1,748
66	3.571	1,088	107	5.790	1,765
67	3.626	1,105	108	5.845	1,781
68	3.680	1,122	109	5.899	1,798
69	3.734	1,138	110	5.953	1,814
70	3.788	1,155	111	6.007	1,831
71	3.842	1,171	112	6.061	1,847
72	3.896	1,188	113	6.115	1,864
73	3.951	1,204	114	6.169	1,880
74	4.004	1,220	115	6.223	1,897
75	4.059	1,237	116	6.278	1,913
76	4.113	1,254	117	6.332	1,930
77	4.167	1,270	118	6.386	1,946
78	4.221	1,287	119	6.440	1,963
79	4.275	1,303	120	6.494	1,979
80	4.329	1,320			

.404" Pitch

DRIVE LINKS	FEET	METERS	DRIVE LINKS	FEET	METERS
40	2.682	0,825	76	5.108	1,557
41	2.755	0,840	77	5.175	1,577
42	2.823	0,860	78	5.242	1,598
43	2.890	0,881	79	5.309	1,618
44	2.957	0,901	80	5.376	1,639
45	3.024	0,922	81	5.444	1,655
46	3.091	0,942	82	5.511	1,680
47	3.159	0,963	83	5.578	1,708
48	3.226	0,983	84	5.645	1,721
49	3.293	1,004	85	5.712	1,741
50	3.360	1,024	86	5.780	1,762
51	3.427	1,045	87	5.847	1,782
52	3.495	1,065	88	5.914	1,803
53	3.562	1,086	89	5.981	1,823
54	3.629	1,106	90	6.048	1,843
55	3.696	1,127	91	6.116	1,864
56	3.763	1,147	92	6.183	1,885
57	3.831	1,168	93	6.250	1,905
58	3.898	1,188	94	6.317	1,925
59	3.965	1,209	95	6.384	1,946
60	4.032	1,229	96	6.452	1,967
61	4.099	1,249	97	6.519	1,987
62	4.167	1,270	98	6.586	2,008
63	4.234	1,291	99	6.653	2,028
64	4.301	1,311	100	6.720	2,048
65	4.368	1,331	101	6.788	2,069
66	4.435	1,352	102	6.855	2,089
67	4.503	1,373	103	6.922	2,110
68	4.570	1,393	104	6.989	2,130
69	4.637	1,413	105	7.056	2,151
70	4.704	1,434	106	7.124	2,171
71	4.772	1,454	107	7.191	2,192
72	4.839	1,475	108	7.258	2,212
73	4.906	1,495	109	7.326	2,233
74	4.973	1,516	110	7.392	2,253
75	5.040	1,536			



SAW CHAIN CONVERSION CHART

TRILINK PART NO.	CHAIN DESCRIPTION	PITCH	GAUGE	CARLTON PART NO.	OREGON PART NO.	STIHL PART NO.
CL143NSTL	Non-Safety Narrow Kerf Semi Chisel Chain	3/8" LP	.043"	N4C	-	61PMN
CL143TL	Safety Narrow Kerf Semi Chisel Chain with Bumper Link	3/8" LP	.043"	N4C-BL	90SG	61PMN1
CL150NSTL	Non-Safety Semi Chisel Chain	3/8" LP	.050"	N1C	91VS	63PM
CL150TL	Safety Semi Chisel Chain with Bumper Link	3/8" LP	.050"	N1C-BL	91VG	63PM1
CL750NSTL	Non-Safety Chisel Chain	.325"	.050"	K1L	33LG	23RS
CL758NSTL	Non-Safety Chisel Chain	.325"	.058"	K2L	34LG	25RS
CL763NSTL	Non-Safety Chisel Chain	.325"	.063"	K3L	35LG	26RS
CL750TL	Safety Chisel Chain with Bumper Link	.325"	.050"	K1L-BL	20LP / 33SL	23RM2
CL758TL	Safety Chisel Chain with Bumper Link	.325"	.058"	K2L-BL	21LP / 34SL	25RM2
CL763TL	Safety Chisel Chain with Bumper Link	.325"	.063"	K3L-BL	22LP / 35SL	26RM2
CL250NSTL	Non-Safety Semi Chisel Chain	.325"	.050"	K1C	-	-
CL258NSTL	Non-Safety Semi Chisel Chain	.325"	.058"	K2C	-	-
CL263NSTL	Non-Safety Semi Chisel Chain	.325"	.063"	K3C	-	-
CL250TL	Safety Semi Chisel Chain with Bumper Link	.325"	.050"	K1C-BL	20BP	23RM
CL258TL	Safety Semi Chisel Chain with Bumper Link	.325"	.058"	K2C-BL	21BP	25RM
CL263TL	Safety Semi Chisel Chain with Bumper Link	.325"	.063"	K3C-BL	22BP	26RM
CL850NSTL	Non-Safety Chisel Chain	3/8"	.050"	A1LM	72LG	33RS
CL858NSTL	Non-Safety Chisel Chain	3/8"	.058"	A2LM	73LG	35RS
CL863NSTL	Non-Safety Chisel Chain	3/8"	.063"	A3LM	75LG	36RS
CL850NSTL	Non-Safety Chisel Chain with Bumper Link	3/8"	.050"	A1LM-BL	72LP	33RS
CL858NSTL	Non-Safety Chisel Chain with Bumper Link	3/8"	.058"	A2LM-BL	73LP	35RS
CL863NSTL	Non-Safety Chisel Chain with Bumper Link	3/8"	.063"	A3LM-BL	75LP	36RS
CL850BLTL	Safety Chisel Chain with Guard Link	3/8"	.050"	A1LM-GL	-	-
CL858BLTL	Safety Chisel Chain with Guard Link	3/8"	.058"	A2LM-GL	-	-
CL863BLTL	Safety Chisel Chain with Guard Link	3/8"	.063"	A3LM-GL	-	-
CL350NSTL	Non-Safety Semi Chisel Chain	3/8"	.050"	A1EP	72DG	33RM
CL358NSTL	Non-Safety Semi Chisel Chain	3/8"	.058"	A2EP	73DG	35RM
CL363NSTL	Non-Safety Semi Chisel Chain	3/8"	.063"	A3EP	75DG	36RM
CL350BLNSTL	Non-Safety Semi Chisel Chain with Bumper Link	3/8"	.050"	A1EP-BL	72DP	33RM
CL358BLNSTL	Non-Safety Semi Chisel Chain with Bumper Link	3/8"	.058"	A2EP-BL	73DP	35RM
CL363BLNSTL	Non-Safety Semi Chisel Chain with Bumper Link	3/8"	.063"	A3EP-BL	75DP	36RM
CL350TL	Safety Semi Chisel Chain with Guard Link	3/8"	.050"	A1EP-GL	72SG	33RM2
CL358TL	Safety Semi Chisel Chain with Guard Link	3/8"	.058"	A2EP-GL	73SG	35RM2
CL363TL	Safety Semi Chisel Chain with Guard Link	3/8"	.063"	A3EP-GL	75SG	36RM2
458NSTL	Non-Safety Semi Chisel Chain	.404"	.058"	B2EP	58	45RM
463NSTL	Non-Safety Semi Chisel Chain	.404"	.063"	B3EP	59	46RM
480NSTL	Non-Safety Harvester Chain	.404"	.080"	B3M	16H	46HM



GUIDE BARS

Our guide bars are designed to provide a guide and support rail for the moving saw chain. Our guide bar types include: Carving Bars, Mini Laminate Sprocket Nose, Laminate Sprocket Nose, Replaceable Sprocket Nose, and Hard Nose bars.

- Solid bars are laser cut for precision fit to exact tolerances
- Guide bar rails are hardened for extra wear
- Stellite™ tips are laser welded on all hard nose bars



READING THE TRILINK PART NUMBER

Guide Bar Numbering System

Example Part Number:

L 3 58 15 56 - 4009 TL

Bar Type	Chain Pitch	Chain Gauge	Bar Length	Drivelink Count	Bar Mount	Brand
M = Mini Laminate (all 3/8" LP)	1 = 3/8" LP	43 = .043"	6" - 36"	66 = 66 drivelinks	See TriLink® Bar Applications List	TL = TriLink®
L = Laminate	2 = .325"	50 = .050"				
R = Replaceable Sprocket Nose	3 = 3/8"	58 = .058"				
H = Hard Nose	4 = .404"	63 = .063"				
CB = Carving Bar		80 = .080"				



TRILINK® CARVING BARS are solid nose bars, constructed from a solid piece of steel, and designed for trimming and pruning. The small nose radius is designed for precision shape cutting. These bars are available in 8" and 12" configurations.

TRILINK PART NO.	BAR TYPE	BAR LENGTH	DRIVE LINKS	PITCH	GAUGE	OREGON PART NO.	CARLTON PART NO.
CB1500837-XXXX*	CARVING BAR	8" (20.32cm)	37	3/8" LP	.050"	--	--
CB1501242-XXXX*	CARVING BAR	12" (30.48cm)	42	3/8" LP	.050"	--	--
CB1501245-XXXX*	CARVING BAR	12" (30.48cm)	45	3/8" LP	.050"	535047	--

*Guide bars are made to fit 1041, 11041, 1095, and 11095 mounts



TRILINK® MINI LAMINATE SPROCKET NOSE BARS have a rotating sprocket located at the tip of the bar with a single rivet construction. As the chain moves along the bar, the sprocket teeth carry the chain around the tip quickly with little friction or reduction in cutting speed. These bars are available in 6" - 18" configurations.

TRILINK PART NO.	BAR TYPE	BAR LENGTH	DRIVE LINKS	PITCH	GAUGE	OREGON PART NO.	CARLTON PART NO.
M1430629-1041TL	MINI LAM. NK	6" (15.24cm)	29	3/8" LP	.043"	064MLEA041	6-10-N4-MHC
M1500629-1041TL	MINI LAM.	6" (15.24cm)	29	3/8" LP	.050"	060SDEA041	6-10-N1-MHC
M1430629-11041TL	MINI LAM. NK	6" (15.24cm)	29	3/8" LP	.043"	064MLEK041	06-10W-N4-MHC
M1430833-1041TL	MINI LAM. NK	8" (20.32cm)	33	3/8" LP	.043"	084MLEA041	08-10-N4-MHC
M1500833-1041TL	MINI LAM.	8" (20.32cm)	33	3/8" LP	.050"	080SDEA041	08-10-N1-MHC
M1430833-1218TL	MINI LAM. NK	8" (20.32cm)	33	3/8" LP	.043"	084MLEA218	08-22-N4-MHC
M1430836-1041TL	MINI LAM. NK	8" (20.32cm)	36	3/8" LP	.043"	084MLEA041	08-10-N437MHC
M1501039-1318TL	MINI LAM.	10" (25.40cm)	39	3/8" LP	.050"	100SDEA318	10-29-N1-MHC
M1431039-1218TL	MINI LAM. NK	10" (25.40cm)	39	3/8" LP	.043"	104MLEA218	10-22-N4-MHC
M1501039-1218TL	MINI LAM.	10" (25.40cm)	39	3/8" LP	.050"	100SDEA218	10-22-N1-MHC
M1431040-1041TL	MINI LAM. NK	10" (25.40cm)	40	3/8" LP	.043"	104MLEA041	10-10-N4-MHC
M1501040-1041TL	MINI LAM.	10" (25.40cm)	40	3/8" LP	.050"	100SDEA041	10-10-N1-MHC
M1431244-1074TL	MINI LAM. NK	12" (30.48cm)	44	3/8" LP	.043"	124MLEA074	12-26-N4-MHC
M1501244-1074TL	MINI LAM.	12" (30.48cm)	44	3/8" LP	.050"	120SPEA074	12-26-N1-HC
M1501244-1074TL	MINI LAM.	12" (30.48cm)	44	3/8" LP	.050"	120SDEA074	12-26-N1-MHC
M1501244-1318TL	MINI LAM.	12" (30.48cm)	44	3/8" LP	.050"	120SPEA318	12-29-N1-MHC
M1431245-1041TL	MINI LAM. NK	12" (30.48cm)	45	3/8" LP	.043"	124MLEA041	12-10-N444-MHC
M1501245-1041TL	MINI LAM.	12" (30.48cm)	45	3/8" LP	.050"	120DGEA041	12-10-N1-MHC

NK = Narrow Kerf

Mini Laminate Sprocket Nose Bars continued on page 25



TRILINK® MINI LAMINATE SPROCKET NOSE BARS (continued)

TRILINK PART NO.	BAR TYPE	BAR LENGTH	DRIVE LINKS	PITCH	GAUGE	OREGON PART NO.	CARLTON PART NO.
M1501245-1041TL	MINI LAM.	12" (30.48cm)	45	3/8" LP	.050"	120SDEA041	12-10-N1-MHC
M1501245-1041TL	MINI LAM.	12" (30.48cm)	45	3/8" LP	.050"	120GPEA041	12-10-N145-HC
M1501245-1041TL	MINI LAM.	12" (30.48cm)	45	3/8" LP	.050"	120SPEA041	12-10-N145-HC
M1501245-1095TL	MINI LAM.	12" (30.48cm)	45	3/8" LP	.050"	120SDEA095	12-01N1-HC
M1501248-1061TL	MINI LAM.	12" (30.48cm)	48	3/8" LP	.050"	120DGEA061	12-28-N1-MHC
M1501449-1318TL	MINI LAM.	14" (35.56cm)	49	3/8" LP	.050"	140SDEA318	14-29-N1-MHC
M1501449-1318TL	MINI LAM.	14" (35.56cm)	49	3/8" LP	.050"	140SPEA318	14-29-N1-HC
M1431450-1074TL	MINI LAM. NK	14" (35.56cm)	50	3/8" LP	.043"	144MLEA074	14-26-N4-MHC
M1501450-1074TL	MINI LAM. 7-9 NOSE TE	14" (35.56cm)	50	3/8" LP	.050"	140SDEA074	14-26-N1-MHC
M1501450-1074TL	MINI LAM.	14" (35.56cm)	50	3/8" LP	.050"	140SPEA074	14-26-N150-HC
M1501450-1318TL	MINI LAM.	14" (35.56cm)	50	3/8" LP	.050"	140SDEA074	14-29-N1-MHC
M1431452-1041TL	MINI LAM. NK	14" (35.56cm)	52	3/8" LP	.043"	144MLEA041	14-10-N4-MHC
M1501452-1041TL	MINI LAM.	14" (35.56cm)	52	3/8" LP	.050"	140DGEA041	14-10-N1-MHC
M1501452-1041TL	MINI LAM.	14" (35.56cm)	52	3/8" LP	.050"	140SDEA041	14-10-N1-MHC
M1501452-1041TL	MINI LAM.	14" (35.56cm)	52	3/8" LP	.050"	140GPEA041	14-10-N152-HC
M1501452-1041TL	MINI LAM.	14" (35.56cm)	52	3/8" LP	.050"	140SPEA041	14-10-N1-HC
M1431452-1095TL	MINI LAM. NK	14" (35.56cm)	52	3/8" LP	.043"	144MLEA095	14-01-N4-MHC
M1501452-1095TL	MINI LAM.	14" (35.56cm)	52	3/8" LP	.050"	140SDEA095	14-01-N1-MHC
M1501452-1095TL	MINI LAM.	14" (35.56cm)	52	3/8" LP	.050"	140SPEA095	14-01-N152-HC
M1501453-1061TL	MINI LAM.	14" (35.56cm)	53	3/8" LP	.050"	140DGEA061	14-28-N1-MHC
M1501654-1318TL	MINI LAM.	16" (40.64cm)	54	3/8" LP	.050"	160SDEA318	16-29-N1-MHC
M1501655-1074TL	MINI LAM.	16" (40.64cm)	55	3/8" LP	.050"	160SDEA074	16-26-N1-MHC
M1501655-1318TL	MINI LAM.	16" (40.64cm)	55	3/8" LP	.050"	160SDEA318	16-29-N1-MHC
M1431656-1041TL	MINI LAM. NK	16" (40.64cm)	56	3/8" LP	.043"	164MLEA041	16-10-N4-MHC
M1501656-1041TL	MINI LAM.	16" (40.64cm)	56	3/8" LP	.050"	160DGEA041	16-10-N1-MHC
M1501656-1041TL	MINI LAM.	16" (40.64cm)	56	3/8" LP	.050"	160GPEA041	16-10-N156-HC
M1501656-1041TL	MINI LAM.	16" (40.64cm)	56	3/8" LP	.050"	160SDEA041	16-10-N1-MHC
M1501656-1041TL	MINI LAM.	16" (40.64cm)	56	3/8" LP	.050"	160SPEA041	16-10-N156-HC
M1501656-1095TL	MINI LAM.	16" (40.64cm)	56	3/8" LP	.050"	160SDEA095	16-01-N1-MHC
M1501657-1041TL	MINI LAM.	16" (40.64cm)	57	3/8" LP	.050"	160SDEA041	16-10-N1-MHC
M1501657-1041TL	MINI LAM.	16" (40.64cm)	57	3/8" LP	.050"	160SPEA041	16-10-N156-HC
M1501659-1061TL	MINI LAM.	16" (40.64cm)	59	3/8" LP	.050"	160DGEA061	16-28-N1-MHC
M1501860-1318TL	MINI LAM.	18" (45.72cm)	60	3/8" LP	.050"	180SDEA318	18-26-N1-MHC
M1501861-1074TL	MINI LAM.	18" (45.72cm)	61	3/8" LP	.050"	180SDEA074	18-26-N1-MHC
M1501862-1041TL	MINI LAM.	18" (45.72cm)	62	3/8" LP	.050"	180DGEA041	18-10-N1-MHC
M1501862-1041TL	MINI LAM.	18" (45.72cm)	62	3/8" LP	.050"	180SDEA041	18-10-N1-MHC
M1501862-1041TL	MINI LAM.	18" (45.72cm)	62	3/8" LP	.050"	180SPEA041	18-10-N1-HC
M1501862-1095TL	MINI LAM.	18" (45.72cm)	62	3/8" LP	.050"	180SDEA095	18-01-N1-MHC

NK = Narrow Kerf



TRILINK® LAMINATE SPROCKET NOSE BARS are light weight bars that are typically used on consumer saws for the occasional or semi-professional user. These bars are available in many applications from 13" - 20" and are the best value for the consumer. TriLink® Laminated Sprocket Nose Bars have a rotating sprocket located at the tip of the bar with a sturdy four rivet construction.

TRILINK PART NO.	BAR TYPE	BAR LENGTH	DRIVE LINKS	PITCH	GAUGE	OREGON PART NO.	CARLTON PART NO.
L1501040-1041TL	LAM.	10" (25.40cm)	40	3/8" LP	.050"	100SDEA041	10-10-N1-HC
L1501244-1074TL	LAM.	12" (30.48cm)	44	3/8" LP	.050"	120SPEA074	12-26-N1-HC
L1501245-1041TL	LAM.	12" (30.48cm)	45	3/8" LP	.050"	120SPEA041	12-10-N145-HC
L1501245-1041TL	LAM.	12" (30.48cm)	45	3/8" LP	.050"	120GPEA041	12-10-N145-HC
L2501356-11095TL	LAM.	13" (33.02cm)	56	.325"	.050"	130MLBK095	13-01W-K1-NKC
L2501356-11095TL	LAM.	13" (33.02cm)	56	.325"	.050"	130MPBK095	13-01W-K1-NKC
L2581356-11095TL	LAM.	13" (33.02cm)	56	.325"	.058"	138SLBK095	13-012-K2-TC12
L1501449-1318TL	LAM.	14" (35.56cm)	49	3/8" LP	.050"	140SPEA318	14-29-N1-HC
L1501450-1074TL	LAM.	14" (35.56cm)	50	3/8" LP	.050"	140SPEA074	14-26-N150-HC
L1501452-1041TL	LAM.	14" (35.56cm)	52	3/8" LP	.050"	140SPEA041	14-10-N1-HC
L1501452-1041TL	LAM.	14" (35.56cm)	52	3/8" LP	.050"	140GPEA041	14-10-N152-HC
L1501452-11095TL	LAM.	14" (35.56cm)	52	3/8" LP	.050"	140SPEK095	14-01-N152-HC
L3581556-4009TL	LAM.	15" (38.10cm)	56	3/8"	.058"	158SLHD009	15-81-A256-TC11
L3631556-4009TL	LAM.	15" (38.10cm)	56	3/8"	.063"	153SLHD009	15-81-A356-TC11
L3501556-4025TL	LAM.	15" (38.10cm)	56	3/8"	.050"	150SLHD025	15-42-K163-TC12
L3581556-4025TL	LAM.	15" (38.10cm)	56	3/8"	.058"	158SLHD025	15-42-K263-TC12
L2501562-4025TL	LAM.	15" (38.10cm)	62	.325"	.050"	150SLHD025	15-42-K163-TC12
L2581562-4025TL	LAM.	15" (38.10cm)	62	.325"	.058"	158SLHD025	15-42-K263-TC12
L2631562-4025TL	LAM.	15" (38.10cm)	62	.325"	.063"	153SLHD025	15-42-K363-TC
L2501564-11041TL	LAM. NK	15" (38.10cm)	64	.325"	.050"	150MLBK041	15-10W-K1-NKC
L2581564-11041TL	LAM.	15" (38.10cm)	64	.325"	.058"	158SLGK041	15-10W-K264-TC12
L2501564-11095TL	LAM. NK	15" (38.10cm)	64	.325"	.050"	150MLBK095	15-01W-K1-NKC
L2501564-11095TL	LAM. NK	15" (38.10cm)	64	.325"	.050"	150MPBK095	15-01W-K2-NKC
L2581564-11095TL	LAM.	15" (38.10cm)	64	.325"	.058"	158SLBK095	15-01W-K264-TC
L2581564-11095TL	LAM.	15" (38.10cm)	64	.325"	.058"	158SLGK095	15-01W-K2-TC12
L1501656-1041TL	LAM.	16" (40.64cm)	56	3/8" LP	.050"	160SPEA041	16-10-N156-HC
L1501656-1041TL	LAM.	16" (40.64cm)	56	3/8" LP	.050"	160GPEA041	16-10-N156-HC
L1501657-1041TL	LAM.	16" (40.64cm)	57	3/8" LP	.050"	160SPEA041	16-10-N156-HC
L3501659-4196TL	LAM.	16" (40.64cm)	59	3/8"	.050"	160GLHD196	16-21-A160-TC11
L3581659-4196TL	LAM.	16" (40.64cm)	59	3/8"	.058"	168GLHD196	16-21-A260-TC11
L3501659-11095TL	LAM.	16" (40.64cm)	59	3/8"	.050"	160PXDK095	16-01W-A159-TC11
L3501660-4009TL	LAM.	16" (40.64cm)	60	3/8"	.050"	160SLHD009	16-81-A160-TC11
L3581660-4009TL	LAM.	16" (40.64cm)	60	3/8"	.058"	168SLHD009	16-81-A260TC
L3501660-4025TL	LAM.	16" (40.64cm)	60	3/8"	.050"	160SLHD025	16-42-A160-TC11
L3581660-4025TL	LAM.	16" (40.64cm)	60	3/8"	.058"	168SLHD025	16-42-A260-TC11
L3631660-4025TL	LAM.	16" (40.64cm)	60	3/8"	.063"	163SLHD025	16-42-A360-TC11
L3501660-4176TL	LAM.	16" (40.64cm)	60	3/8"	.050"	160SLHD176	16-41-A160-TC11
L3581660-4176TL	LAM.	16" (40.64cm)	60	3/8"	.058"	168GLHD176	16-41H-A260-TC11
L3501660-11095TL	LAM.	16" (40.64cm)	60	3/8"	.050"	160SLHK095	16-01W-A160-TC11
L3581660-11095TL	LAM.	16" (40.64cm)	60	3/8"	.058"	168SLHK095	16-01W-A3-TC11
L3581660-11095TL	LAM.	16" (40.64cm)	60	3/8"	.058"	168SLHK095	16-01W-A3-TC
L2501662-1074TL	LAM.	16" (40.64cm)	62	.325"	.050"	160SLBA074	16-26-K162-TC

NK = Narrow Kerf

Laminated Sprocket Nose Bars continued on page 27



TRILINK® LAMINATE SPROCKET NOSE BARS (continued)

TRILINK PART NO.	BAR TYPE	BAR LENGTH	DRIVE LINKS	PITCH	GAUGE	OREGON PART NO.	CARLTON PART NO.
L2501662-1074TL	LAM. NK	16" (40.64cm)	62	.325"	.050"	160MPBA074	16-26-K1-NKC
L2631662-1074TL	LAM.	16" (40.64cm)	62	.325"	.063"	163MPBA074	16-26-K362-TC
L2501666-11041TL	LAM.	16" (40.64cm)	66	.325"	.050"	160GDBK041	16-10W-K1-HC
L2501666-11041TL	LAM. NK	16" (40.64cm)	66	.325"	.050"	160MLBK041	16-10W-K1-NKC
L2581666-11041TL	LAM.	16" (40.64cm)	66	.325"	.058"	168SLGK041	16-09-K266-TC12
L2501666-11095TL	LAM. NK	16" (40.64cm)	66	.325"	.050"	160MLBK095	16-01W-K1-NKC
L2501666-11095TL	LAM.	16" (40.64cm)	66	.325"	.050"	160PXBK095	16-01W-K1-HC
L2501666-11095TL	LAM.	16" (40.64cm)	66	.325"	.050"	160MPBK095	16-01W-K1-NKC
L2501666-11095TL	LAM.	16" (40.64cm)	66	.325"	.050"	160SLGK095	16-01W-K166-TC12
L2581666-11095TL	LAM.	16" (40.64cm)	66	.325"	.058"	168PXBK095	16-01W-K266-HC
L2581666-11095TL	LAM.	16" (40.64cm)	66	.325"	.058"	168SLBK095	16-01W-K266-TC
L2581666-11095TL	LAM.	16" (40.64cm)	66	.325"	.058"	168SLGK095	16-01W-K2-TC12
L2501667-4025TL	LAM.	16" (40.64cm)	67	.325"	.050"	160SLGD025	16-42-K167-TC12
L2581667-4025TL	LAM.	16" (40.64cm)	67	.325"	.058"	168SLGD025	16-42-K367-TC
L2631667-4025TL	LAM.	16" (40.64cm)	67	.325"	.063"	163SLGD025	16-42-K367-TC12
L1501862-1041TL	LAM.	18" (45.72cm)	62	3/8" LP	.050"	180SPEA041	18-10-N1-HC
L1501864-4176TL	LAM.	18" (45.72cm)	64	3/8" LP	.050"	180SLHD176	18-41-N1-HC
L3501864-11095TL	LAM.	18" (45.72cm)	64	3/8"	.050"	180SLHK095	18-01W-A164-TC11
L3581864-11095TL	LAM.	18" (45.72cm)	64	3/8"	.058"	188SLHK095	18-01W-A264-TC11
L3501866-4025TL	LAM.	18" (45.72cm)	66	3/8"	.050"	180SLHD025	18-42-A166-TC11
L3581866-4025TL	LAM.	18" (45.72cm)	66	3/8"	.058"	188SLHD025	18-42-A266-TC11
L3631866-4025TL	LAM.	18" (45.72cm)	66	3/8"	.063"	183SLHD025	18-42-A366-TC11
L3501866-4176TL	LAM.	18" (45.72cm)	66	3/8"	.050"	180GDDD176	18-41-A166-TC
L3581866-4176TL	LAM.	18" (45.72cm)	66	3/8"	.058"	188PXDD176	18-41-A266-TC
L3501868-4009TL	LAM.	18" (45.72cm)	68	3/8"	.050"	180SLHD009	18-81-A168-TC11
L3581868-4009TL	LAM.	18" (45.72cm)	68	3/8"	.058"	188SLHD009	18-81-A268-TC
L3631868-4009TL	LAM.	18" (45.72cm)	68	3/8"	.063"	183SLHD009	18-82-A368-TC11
L2501872-11041TL	LAM.	18" (45.72cm)	72	.325"	.050"	180GDBK041	18-102-K1-HC
L2501872-11041TL	LAM. NK	18" (45.72cm)	72	.325"	.050"	180MLBK041	18-10W-K1-NKC
L2501872-11041TL	LAM.	18" (45.72cm)	72	.325"	.050"	180SLBK041	18-09-K172-TC
L2501872-11041TL	LAM.	18" (45.72cm)	72	.325"	.050"	180SLGK041	18-09-K1-TC12
L2581872-11041TL	LAM.	18" (45.72cm)	72	.325"	.058"	188SLGK041	18-01W-K272-TC12
L2501872-11095TL	LAM. NK	18" (45.72cm)	72	.325"	.050"	180MLBK095	18-01W-K1-NKC
L2501872-11095TL	LAM. NK	18" (45.72cm)	72	.325"	.050"	180MPBK095	18-01W-K1-NKC
L2501872-11095TL	LAM.	18" (45.72cm)	72	.325"	.050"	180SLGK095	18-01W-K1-TC12
L2501872-11095TL	LAM.	18" (45.72cm)	72	.325"	.050"	180SLBK095	180-01W-K172-TC
L2501872-11095TL	LAM. NK	18" (45.72cm)	72	.325"	.050"	180MPBK095	18-01W-K1-TC12
L2581872-11095TL	LAM.	18" (45.72cm)	72	.325"	.058"	188SLBK095	18-01W-K272-TC
L2581872-11095TL	LAM.	18" (45.72cm)	72	.325"	.058"	188PXBK095	18-09-K272-TC12
L2581872-11095TL	LAM.	18" (45.72cm)	72	.325"	.058"	188SLGK095	18-01W-K2-TC12
L2501874-4025TL	LAM.	18" (45.72cm)	74	.325"	.050"	180SLGD025	18-42-K174-TC12
L2581874-4025TL	LAM.	18" (45.72cm)	74	.325"	.058"	188SLGD025	18-42-K274-TC
L2631874-4025TL	LAM.	18" (45.72cm)	74	.325"	.063"	183SLGD025	18-42-K3-TC12
L2501874-4176TL	LAM.	18" (45.72cm)	74	.325"	.050"	180PXB176	18-41-K174-TC10
L3502070-4176TL	LAM.	20" (50.80cm)	70	3/8"	.050"	200GLHD176	20-41-K170-TC12
L3582070-4176TL	LAM.	20" (50.80cm)	70	3/8"	.058"	208PXDD176	20-24-A270-TC

NK = Narrow Kerf

Laminate Sprocket Nose Bars continued on page 28



TRILINK® LAMINATE SPROCKET NOSE BARS (continued)

TRILINK PART NO.	BAR TYPE	BAR LENGTH	DRIVE LINKS	PITCH	GAUGE	OREGON PART NO.	CARLTON PART NO.
L3632070-4176TL	LAM.	20" (50.80cm)	70	3/8"	.063"	200SLHD176	20-41-A170-TC11
L3502072-4009TL	LAM.	20" (50.80cm)	72	3/8"	.050"	200SLHD009	20-81-A172-TC11
L3582072-4009TL	LAM.	20" (50.80cm)	72	3/8"	.058"	208SFHD009	20-81-A272-TC
L3582072-4009TL	LAM.	20" (50.80cm)	72	3/8"	.058"	208SLHD009	20-81-A272-TC11
L3632072-4009TL	LAM.	20" (50.80cm)	72	3/8"	.063"	203SLHD009	20-81-A372-TC11
L3502072-4025TL	LAM.	20" (50.80cm)	72	3/8"	.050"	200SLHD025	20-42-A172-TC11
L3582072-4025TL	LAM.	20" (50.80cm)	72	3/8"	.058"	208SLHD025	20-71-A272-TC11
L3632072-4025TL	LAM.	20" (50.80cm)	72	3/8"	.063"	203SLHD025	20-42-A372-TC11
L2502078-1041TL	LAM.	20" (50.80cm)	78	.325"	.050"	200SLGA041	20-10-K1-TC
L2502078-11041TL	LAM.	20" (50.80cm)	78	.325"	.050"	200SLGK041	20-10W-K1-TC12
L2502078-11041TL	LAM.	20" (50.80cm)	78	.325"	.050"	200PXBK041	20-09-K178-TC
L2582078-11041TL	LAM.	20" (50.80cm)	78	.325"	.058"	208SLGK041	20-09-K278-TC12
L2582081-4025TL	LAM.	20" (50.80cm)	81	.325"	.058"	208SLGD025	20-42-K281-TC12
L2632081-4025TL	LAM.	20" (50.80cm)	81	.325"	.063"	203SLGD025	20-42-K381-TC12



TRILINK® REPLACEABLE SPROCKET NOSE BARS have a solid steel body with a replaceable sprocket nose tip. This tip can be changed as it wears out without having to replace the entire bar. These bars are manufactured for high speed, heavy duty saws and are preferred by the professional and semi-professional cutter; available in 13" - 36" configurations.

TRILINK PART NO.	BAR TYPE	BAR LENGTH	DRIVE LINKS	PITCH	GAUGE	OREGON PART NO.	CARLTON PART NO.
R3581352-4009TL	REPL. SPRC. NOSE	13" (33.02cm)	52	3/8"	.058"	138RNDD009	13-81-A252-PS
R3631352-4009TL	REPL. SPRC. NOSE	13" (33.02cm)	52	3/8"	.063"	133RNDD009	13-81-A352-PS
R3581352-4025TL	REPL. SPRC. NOSE	13" (33.02cm)	52	3/8"	.058"	138RNDD025	13-42-A252-PS
R3631352-4025TL	REPL. SPRC. NOSE	13" (33.02cm)	52	3/8"	.063"	133RNDD025	13-42-352-PS
R2581359-4009TL	REPL. SPRC. NOSE	13" (33.02cm)	59	.325"	.058"	138RNBD009	13-81-K256-PS
R2631359-4009TL	REPL. SPRC. NOSE	13" (33.02cm)	59	.325"	.063"	133RNBD009	13-81-K356-PS
R2581359-4025TL	REPL. SPRC. NOSE	13" (33.02cm)	59	.325"	.058"	138RNBD025	13-42-K256-PS
R2631359-4025TL	REPL. SPRC. NOSE	13" (33.02cm)	59	.325"	.063"	133RNBD025	13-42-K356-PS
R3581556-4009TL	REPL. SPRC. NOSE	15" (38.10cm)	56	3/8"	.058"	158RNDD009	15-81-A256-PS
R3631556-4009TL	REPL. SPRC. NOSE	15" (38.10cm)	56	3/8"	.063"	153RNDD009	15-81-A3-PS
R3581556-4025TL	REPL. SPRC. NOSE NK	15" (38.10cm)	56	3/8"	.058"	158RNDD025	15-42-A256-PS
R3631556-4025TL	REPL. SPRC. NOSE NK	15" (38.10cm)	56	3/8"	.063"	153RNDD025	15-42-A356-PS

NK = Narrow Kerf

Replaceable Sprocket Nose Bars continued on page 29



TRILINK® REPLACEABLE SPROCKET NOSE BARS (continued)

TRILINK PART NO.	BAR TYPE	BAR LENGTH	DRIVE LINKS	PITCH	GAUGE	OREGON PART NO.	CARLTON PART NO.
R3581556-11095TL	REPL. SPRC. NOSE	15" (38.10cm)	56	3/8"	.058"	158RNDK095	15-01W-A256-PS
R3631556-11095TL	REPL. SPRC. NOSE	15" (38.10cm)	56	3/8"	.063"	153RNDK095	15-01W-A356-PS
R2581564-11095TL	REPL. SPRC. NOSE	15" (38.10cm)	64	.325"	.058"	158RNBK095	15-01W-K264-PS
R2631564-11095TL	REPL. SPRC. NOSE	15" (38.10cm)	64	.325"	.063"	153RNBK095	15-01W-K3-PS
R3581659-11095TL	REPL. SPRC. NOSE	16" (40.64cm)	59	3/8"	.058"	168RNDK095	16-01W-A2-PS
R3581659-11095TL	REPL. SPRC. NOSE	16" (40.64cm)	59	3/8"	.058"	168RNDK095	16-01W-A260-PS
R3631659-11095TL	REPL. SPRC. NOSE	16" (40.64cm)	59	3/8"	.063"	163RNDK095	16-01W-A3-PS
R3631659-11095TL	REPL. SPRC. NOSE	16" (40.64cm)	59	3/8"	.063"	163RNDK095	16-01W-A360-PS
R3581660-4009TL	REPL. SPRC. NOSE	16" (40.64cm)	60	3/8"	.058"	168RND009	16-81-A260-PS
R3631660-4009TL	REPL. SPRC. NOSE	16" (40.64cm)	60	3/8"	.063"	163RND009	16-81-A360-PS
R3581660-4025TL	REPL. SPRC. NOSE	16" (40.64cm)	60	3/8"	.058"	168RND025	16-42-A260-PS
R3631660-4025TL	REPL. SPRC. NOSE	16" (40.64cm)	60	3/8"	.063"	163RND025	16-42-A360-PS
R3581660-4176TL	REPL. SPRC. NOSE	16" (40.64cm)	60	3/8"	.058"	168RND176	16-41-A2-PS
R3581660-4176TL	REPL. SPRC. NOSE	16" (40.64cm)	60	3/8"	.058"	168RND176	16-41-A260-PS
R3631660-4176TL	REPL. SPRC. NOSE	16" (40.64cm)	60	3/8"	.063"	163RND176	16-41-A3-PS
R3631660-4176TL	REPL. SPRC. NOSE	16" (40.64cm)	60	3/8"	.063"	163RND176	16-41-A360-PS
R3581660-4196TL	REPL. SPRC. NOSE	16" (40.64cm)	60	3/8"	.058"	168RND196	16-21-A260-PS
R3631660-4196TL	REPL. SPRC. NOSE	16" (40.64cm)	60	3/8"	.063"	163RND196	16-21-A3-PS
R2581666-11095TL	REPL. SPRC. NOSE	16" (40.64cm)	66	.325"	.058"	168RNBK095	16-01W-K266-PS
R2631666-11095TL	REPL. SPRC. NOSE	16" (40.64cm)	66	.325"	.063"	163RNBK095	16-01W-K3-PS
R3581764-4009TL	REPL. SPRC. NOSE	17" (43.18cm)	64	3/8"	.058"	178RND009	17-81-A264-PS
R3631764-4009TL	REPL. SPRC. NOSE	17" (43.18cm)	64	3/8"	.063"	173RND009	17-82-A364-PS
R3581764-4025TL	REPL. SPRC. NOSE	17" (43.18cm)	64	3/8"	.058"	178RND025	17-42-A264-PS
R3631764-4025TL	REPL. SPRC. NOSE	17" (43.18cm)	64	3/8"	.063"	173RND025	17-42-A364-PS
R3581866-4025TL	REPL. SPRC. NOSE	18" (45.72cm)	66	3/8"	.058"	188RND025	18-42-A266-PS
R3631866-4025TL	REPL. SPRC. NOSE	18" (45.72cm)	66	3/8"	.063"	183RND025	18-42-A366-PS
R3581868-4009TL	REPL. SPRC. NOSE	18" (45.72cm)	68	3/8"	.058"	188RND009	18-81-A268-PS
R3631868-4009TL	REPL. SPRC. NOSE	18" (45.72cm)	68	3/8"	.063"	183RND009	18-81-A368-PS
R3581868-11095TL	REPL. SPRC. NOSE	18" (45.72cm)	68	3/8"	.058"	188RNDK095	18-01W-A264-PS
R3631868-11095TL	REPL. SPRC. NOSE	18" (45.72cm)	68	3/8"	.063"	183RNDK095	18-01W-A364-PS
R2581872-11041TL	REPL. SPRC. NOSE	18" (45.72cm)	72	.325"	.058"	188RNB041	18-10-A272-PS
R2631872-11041TL	REPL. SPRC. NOSE	18" (45.72cm)	72	.325"	.063"	183RNB041	18-10W-K372-PS
R2581872-11095TL	REPL. SPRC. NOSE	18" (45.72cm)	72	.325"	.058"	188RNBK095	18-01W-K272-PS
R2631872-11095TL	REPL. SPRC. NOSE	18" (45.72cm)	72	.325"	.063"	183RNBK095	18-01W-K372-PS
R2581874-4025TL	REPL. SPRC. NOSE	18" (45.72cm)	74	.325"	.058"	188RNB025	18-42-K274-PS
R2631874-4025TL	REPL. SPRC. NOSE	18" (45.72cm)	74	.325"	.063"	183RNB025	18-42-K374-PS
R4632062-13015TL	REPL. SPRC. NOSE	20" (50.80cm)	62	.404"	.063"	203RNF015	20-81-B362-PS
R4632065-4009TL	REPL. SPRC. NOSE	20" (50.80cm)	65	.404"	.063"	203RNF009	20-81-B365-PS
R3582070-4176TL	REPL. SPRC. NOSE	20" (50.80cm)	70	3/8"	.058"	208RND176	20-41-A270-PS
R3582070-4196TL	REPL. SPRC. NOSE	20" (50.80cm)	70	3/8"	.058"	208RND196	20-21-A270-PS
R3632070-4176TL	REPL. SPRC. NOSE	20" (50.80cm)	70	3/8"	.063"	203RND176	20-41-A370-PS
R3632070-4196TL	REPL. SPRC. NOSE	20" (50.80cm)	70	3/8"	.063"	203RND196	20-21-A370-PS
R3582072-4009TL	REPL. SPRC. NOSE	20" (50.80cm)	72	3/8"	.058"	208RND009	20-81-A272-PS
R3632072-4009TL	REPL. SPRC. NOSE	20" (50.80cm)	72	3/8"	.063"	203RND009	20-81-A372-PS

NK = Narrow Kerf

Replaceable Sprocket Nose Bars continued on page 30

TRILINK® REPLACEABLE SPROCKET NOSE BARS (continued)

TRILINK PART NO.	BAR TYPE	BAR LENGTH	DRIVE LINKS	PITCH	GAUGE	OREGON PART NO.	CARLTON PART NO.
R3582072-4025TL	REPL. SPRC. NOSE	20" (50.80cm)	72	3/8"	.058"	208RNDD025	20-42-A272-PS
R3632072-4025TL	REPL. SPRC. NOSE	20" (50.80cm)	72	3/8"	.063"	203RNDD025	20-42-A372-PS
R3582072-4176TL	REPL. SPRC. NOSE	20" (50.80cm)	72	3/8"	.058"	208RNDD176	20-41-A272-PS
R3632072-4176TL	REPL. SPRC. NOSE	20" (50.80cm)	72	3/8"	.063"	203RNDD176	20-41-A372-PS
R3582072-11095TL	REPL. SPRC. NOSE	20" (50.80cm)	72	3/8"	.058"	208RNDDK095	20-01W-A272-PS
R3632072-11095TL	REPL. SPRC. NOSE	20" (50.80cm)	72	3/8"	.063"	203RNDDK095	20-01W-A372-PS
R2582078-11095TL	REPL. SPRC. NOSE	20" (50.80cm)	78	.325"	.058"	208RNBK095	20-01W-K278-PS
R2632078-11095TL	REPL. SPRC. NOSE	20" (50.80cm)	78	.325"	.063"	203RNBK095	20-01W-K378-PS
R2582081-4025TL	REPL. SPRC. NOSE	20" (50.80cm)	81	.325"	.058"	208RNBD025	20-42-K281-PS
R2632081-4025TL	REPL. SPRC. NOSE	20" (50.80cm)	81	.325"	.063"	203RNBD025	20-42-K378-PS
R4632168-5031TL	REPL. SPRC. NOSE	21" (53.34cm)	68	.404"	.063"	213RNFE031	21-07-B368-PS
R3582276-4009TL	REPL. SPRC. NOSE	22" (55.88cm)	76	3/8"	.058"	228RNDD009	22-81-A276-PS
R3632276-4009TL	REPL. SPRC. NOSE	22" (55.88cm)	76	3/8"	.063"	223RNDD009	22-81-A376-PS
R3582276-4025TL	REPL. SPRC. NOSE	22" (55.88cm)	76	3/8"	.058"	228RNDD025	22-42-A276-PS
R3632276-4025TL	REPL. SPRC. NOSE	22" (55.88cm)	76	3/8"	.063"	223RNDD025	22-42-A376-PS
R3582380-4009TL	REPL. SPRC. NOSE	23" (58.42cm)	80	3/8"	.058"	238RNDD009	23-81-A280-PS
R3632380-4009TL	REPL. SPRC. NOSE	23" (58.42cm)	80	3/8"	.063"	233RNDD009	23-81-A380-PS
R3582380-4025TL	REPL. SPRC. NOSE	23" (58.42cm)	80	3/8"	.058"	238RNDD025	23-42-A280-PS
R3632380-4025TL	REPL. SPRC. NOSE	23" (58.42cm)	80	3/8"	.063"	233RNDD025	23-42-A380-PS
R4632476-4009TL	REPL. SPRC. NOSE	24" (60.96cm)	76	.404"	.063"	243RNFD009	24-81-B376-PS
R3582481-4176TL	REPL. SPRC. NOSE	24" (60.96cm)	81	3/8"	.058"	248RNDD176	24-41-A281-PS
R3632481-4176TL	REPL. SPRC. NOSE	24" (60.96cm)	81	3/8"	.063"	243RNDD176	24-41-A381-PS
R3582481-4196TL	REPL. SPRC. NOSE	24" (60.96cm)	81	3/8"	.058"	248RNDD196	24-21-A281-PS
R3632481-4196TL	REPL. SPRC. NOSE	24" (60.96cm)	81	3/8"	.063"	243RNDD196	24-21-A381-PS
R3582484-4009TL	REPL. SPRC. NOSE	24" (60.96cm)	84	3/8"	.058"	248RNDD009	24-81-A284-PS
R3632484-4009TL	REPL. SPRC. NOSE	24" (60.96cm)	84	3/8"	.063"	243RNDD009	24-81-A384-PS
R3582484-4025TL	REPL. SPRC. NOSE	24" (60.96cm)	84	3/8"	.058"	248RNDD025	24-42-A284-PS
R3632484-4025TL	REPL. SPRC. NOSE	24" (60.96cm)	84	3/8"	.063"	243RNDD025	24-42-A384-PS
R2582490-11095TL	REPL. SPRC. NOSE	24" (60.96cm)	90	.325"	.058"	248RNBK095	24-01W-K290-PS
R2632490-11095TL	REPL. SPRC. NOSE	24" (60.96cm)	90	.325"	.063"	243RNBK095	24-01W-K390-PS
R4632580-5031TL	REPL. SPRC. NOSE	25" (63.50cm)	80	.404"	.063"	253RNFE031	25-07-B380-PS
R3582891-4025TL	REPL. SPRC. NOSE	28" (71.12cm)	91	3/8"	.058"	288RNDD025	28-42-A292-PS
R3502892-4009TL	REPL. SPRC. NOSE	28" (71.12cm)	92	3/8"	.050"	280RNHD009	28-81-A192-PS
R3582892-4009TL	REPL. SPRC. NOSE	28" (71.12cm)	92	3/8"	.058"	288RNDD009	28-81-A292-PS
R3582892-4009TL	REPL. SPRC. NOSE	28" (71.12cm)	92	3/8"	.058"	288RNHD009	28-81-A292-PS
R3632892-4009TL	REPL. SPRC. NOSE	28" (71.12cm)	92	3/8"	.063"	283RNDD009	28-81-A393-PS
R3632892-4009TL	REPL. SPRC. NOSE	28" (71.12cm)	92	3/8"	.063"	283RNHD009	28-81-A392-PS
R3632892-4025TL	REPL. SPRC. NOSE	28" (71.12cm)	92	3/8"	.063"	283RNDD025	28-42-A392-PS
R4633092-5031TL	REPL. SPRC. NOSE	30" (76.20cm)	92	.404"	.063"	303RNFE031	30-07-B392-PS
R3583098-4025TL	REPL. SPRC. NOSE	30" (76.20cm)	98	3/8"	.058"	308RNDD025	30-42-A298-PS
R3633098-4025TL	REPL. SPRC. NOSE	30" (76.20cm)	98	3/8"	.063"	303RNDD025	30-42-A398-PS
R35836114-4025TL	REPL. SPRC. NOSE	36" (91.44cm)	114	3/8"	.058"	368RNDD025	36-42-A2114-PS
R36336114-4025TL	REPL. SPRC. NOSE	36" (91.44cm)	114	3/8"	.063"	363RNDD025	36-42-A3114-PS
R35836115-4009TL	REPL. SPRC. NOSE	36" (91.44cm)	115	3/8"	.058"	368RNDD009	36-81-A2115-PS
R36336115-4009TL	REPL. SPRC. NOSE	36" (91.44cm)	115	3/8"	.063"	363RNDD009	36-81-A3115-PS



TRILINK® SOLID HARD NOSE BARS are constructed from one solid piece of steel with Stellite™ alloy laser welded onto the tip. Solid nose bars are designed for dirty cutting conditions as they have no moving bearings to get clogged. These bars are also frequently used for bore cutting. TriLink® Solid Hard Nose Bars are typically used by professional cutters because of their extreme strength and durability.

TRILINK PART NO.	BAR TYPE	BAR LENGTH	DRIVE LINKS	PITCH	GAUGE	OREGON PART NO.	CARLTON PART NO.
H1581245-1041TL	HARD NOSE 1.33"	12" (30.48cm)	45	3/8" LP	.058"	128ATMA041	12-10-N245-PH
H3581352-4009TL	HARD NOSE 1.33"	13" (33.02cm)	52	3/8"	.058"	138ATMD009	13-81-A252-PH
H3631352-4009TL	HARD NOSE 1.33"	13" (33.02cm)	52	3/8"	.063"	133ATMD009	13-81-A352-PH
H3581352-4025TL	HARD NOSE 1.33"	13" (33.02cm)	52	3/8"	.058"	138ATMD025	13-42-A252-PH
H3631352-4025TL	HARD NOSE 1.33"	13" (33.02cm)	52	3/8"	.063"	1331TMD025	13-42-A352-PH
H2631359-4009TL	HARD NOSE 1.33"	13" (33.02cm)	59	.325"	.063"	133ATMD009	13-81-K356-PH
H2581359-4025TL	HARD NOSE 1.33"	13" (33.02cm)	59	.325"	.058"	138ATMD025	13-42-K256-PH
H1581453-1041TL	HARD NOSE 1.33"	14" (35.56cm)	53	3/8" LP	.058"	148LAMA041	14-10-N253-PH
H3581556-4009TL	HARD NOSE 1.33"	15" (38.10cm)	56	3/8"	.058"	158ATMD009	15-81-A256-PH
H3631556-4009TL	HARD NOSE 1.33"	15" (38.10cm)	56	3/8"	.063"	153ATMD009	15-81-A356-PH
H3581556-4025TL	HARD NOSE 1.33"	15" (38.10cm)	56	3/8"	.058"	158ATMD025	15-42-A256-PH
H3631556-4025TL	HARD NOSE 1.33"	15" (38.10cm)	56	3/8"	.063"	153ATMD025	15-42-A356-PH
H3581556-11095TL	HARD NOSE 1.33"	15" (38.10cm)	56	3/8"	.058"	158ATMK095	15-01W-A256-PH
H3631556-11095TL	HARD NOSE 1.33"	15" (38.10cm)	56	3/8"	.063"	153ATMK095	15-01W-A356-PH
H2581564-11095TL	HARD NOSE 1.33"	15" (38.10cm)	64	.325"	.058"	158ATBMK095	15-01W-K264-PH
H2631564-11095TL	HARD NOSE 1.33"	15" (38.10cm)	64	.325"	.063"	153ATMK095	15-01W-K364-PH
H1581655-1074TL	HARD NOSE 1.33"	16" (40.64cm)	55	3/8" LP	.058"	168ATMA074	16-26-N255-PH
H3581659-4176TL	HARD NOSE 1.33"	16" (40.64cm)	59	3/8"	.058"	168ATMD176	16-41-A259-PH
H3631659-4176TL	HARD NOSE 1.33"	16" (40.64cm)	59	3/8"	.063"	163ATMD176	16-41-A359-PH
H3581659-11095TL	HARD NOSE 1.33"	16" (40.64cm)	59	3/8"	.058"	168ATMK095	16-01W-A259-PH
H3631659-11095TL	HARD NOSE 1.33"	16" (40.64cm)	59	3/8"	.063"	163ATMK095	16-01W-A359-PH
H3581660-4009TL	HARD NOSE 1.33"	16" (40.64cm)	60	3/8"	.058"	168ATMD009	16-81-A260-PH
H3631660-4009TL	HARD NOSE 1.33"	16" (40.64cm)	60	3/8"	.063"	163ATMD009	16-81-A360-PH
H3581660-4009TL	HARD NOSE 1.33"	16" (40.64cm)	60	3/8"	.058"	168ATMD025	16-42-A360-PH
H3631660-4025TL	HARD NOSE 1.33"	16" (40.64cm)	60	3/8"	.063"	163ATMD025	16-42-A360-PH
H3581660-4176TL	HARD NOSE 1.33"	16" (40.64cm)	60	3/8"	.058"	168ATMD176	16-41-A260-PH
H3631660-4176TL	HARD NOSE 1.33"	16" (40.64cm)	60	3/8"	.063"	163ATMD176	16-41-A360-PH
H3581660-4196TL	HARD NOSE 1.33"	16" (40.64cm)	60	3/8"	.058"	168ATMD196	16-21-A260-PH
H3631660-4196TL	HARD NOSE 1.33"	16" (40.64cm)	60	3/8"	.063"	163ATMD196	16-21-A360-PH
H3581660-11095TL	HARD NOSE 1.33"	16" (40.64cm)	60	3/8"	.058"	168ATMK095	16-01W-058-PH
H3631660-11095TL	HARD NOSE 1.33"	16" (40.64cm)	60	3/8"	.063"	163ATMK095	16-01W-A360-PH
H2581664-1041TL	HARD NOSE 1.33"	16" (40.64cm)	64	.325"	.058"	168ATBMA041	16-10-K264-PH
H2631664-1041TL	HARD NOSE 1.33"	16" (40.64cm)	64	.325"	.063"	163ATBMA041	16-10-K364-PH
H2581666-11095TL	HARD NOSE 1.33"	16" (40.64cm)	66	.325"	.058"	168ATMK095	16-01W-K266-PH
H2631666-11095TL	HARD NOSE 1.33"	16" (40.64cm)	66	.325"	.063"	163ATMK095	16-01W-K366-PH
H4631760-5099TL	HARD NOSE 1.33"	17" (43.18cm)	60	.404"	.063"	173ATME099	17-?-B360-PH
H4631761-5033TL	HARD NOSE 1.33"	17" (43.18cm)	61	.404"	.063"	173ATME033	--
H3581764-4009TL	HARD NOSE 1.33"	17" (43.18cm)	64	3/8"	.058"	178ATMD009	17-81-A264-PH
H3631764-4009TL	HARD NOSE 1.33"	17" (43.18cm)	64	3/8"	.063"	173ATMD009	17-81-A364-PH

Hard Nose Bars continued on page 32

TRILINK® SOLID HARD NOSE BARS (continued)

TRILINK PART NO.	BAR TYPE	BAR LENGTH	DRIVE LINKS	PITCH	GAUGE	OREGON PART NO.	CARLTON PART NO.
H3581764-4025TL	HARD NOSE 1.33"	17" (43.18cm)	64	3/8"	.058"	178ATMD025	17-42-A264-PH
H3631764-4025TL	HARD NOSE 1.33"	17" (43.18cm)	64	3/8"	.063"	173ATMD025	17-42-A364-PH
H3581860-1074TL	HARD NOSE 1.33"	18" (45.72cm)	60	3/8"	.058"	188ATMA074	18-26-N360-PH
H3581864-4196TL	HARD NOSE 1.33"	18" (45.72cm)	64	3/8"	.058"	188ATMD196	18-21-A264-PH
H3631864-4196TL	HARD NOSE 1.33"	18" (45.72cm)	64	3/8"	.063"	183ATMD196	18-21-A364-PH
H3581864-11095TL	HARD NOSE 1.33"	18" (45.72cm)	64	3/8"	.058"	188ATMK095	18-01W-058-PH
H3631864-11095TL	HARD NOSE 1.33"	18" (45.72cm)	64	3/8"	.063"	183ATMK095	18-01W-A364-PH
H3581866-4025TL	HARD NOSE 1.33"	18" (45.72cm)	66	3/8"	.058"	188ATMD025	18-42-A266-PH
H3631866-4025TL	HARD NOSE 1.33"	18" (45.72cm)	66	3/8"	.063"	183LAMD025	18-42-A366-PH
H3581868-4009TL	HARD NOSE 1.33"	18" (45.72cm)	68	3/8"	.058"	188ATMD009	18-81-A268-PH
H3631868-4009TL	HARD NOSE 1.33"	18" (45.72cm)	68	3/8"	.063"	183LAMD009	18-81-A366-PH
H3581868-11095TL	HARD NOSE 1.33"	18" (45.72cm)	68	3/8"	.058"	188ATMK095	18-01W-058-PH
H3631868-11095TL	HARD NOSE 1.33"	18" (45.72cm)	68	3/8"	.063"	183ATMK095	18-01W-A364-PH
H2581872-11041TL	HARD NOSE 1.33"	18" (45.72cm)	72	.325"	.058"	188ATMK041	18-01W-K272-PH
H2631872-11041TL	HARD NOSE 1.33"	18" (45.72cm)	72	.325"	.063"	183ATMK041	18-10W-K372-PH
H2631872-11095TL	HARD NOSE 1.33"	18" (45.72cm)	72	.325"	.063"	183ATMK095	18-01W-K372-PH
H2581874-4025TL	HARD NOSE 1.33"	18" (45.72cm)	74	.325"	.058"	188ATMD025	18-42-K274-PH
H2631874-4025TL	HARD NOSE 1.33"	18" (45.72cm)	74	.325"	.063"	183ATMD025	18-42-K374-PH
H4632065-4009TL	HARD NOSE 1.33"	20" (50.80cm)	65	.404"	.063"	203ATMD009	20-81-B365-PH
H3582070-1074TL	HARD NOSE 1.33"	20" (50.80cm)	70	3/8"	.058"	208LAMA074	20-26-N370-PH
H3582070-4176TL	HARD NOSE 1.33"	20" (50.80cm)	70	3/8"	.058"	208ATMD176	20-41-A270-PH
H3632070-4176TL	HARD NOSE 1.33"	20" (50.80cm)	70	3/8"	.063"	203ATMD176	20-41-A370-PH
H3582070-4196TL	HARD NOSE 1.33"	20" (50.80cm)	70	3/8"	.058"	208ATMD196	20-21-A270-PH
H3632070-4196TL	HARD NOSE 1.33"	20" (50.80cm)	70	3/8"	.063"	203ATMD196	20-21-A370-PH
H3582072-4009TL	HARD NOSE 1.33"	20" (50.80cm)	72	3/8"	.058"	208ATMD009	20-81-A272-PH
H3632072-4009TL	HARD NOSE 1.33"	20" (50.80cm)	72	3/8"	.063"	203ATMD009	20-81-A372-PH
H3632072-4024TL	HARD NOSE 1.33"	20" (50.80cm)	72	3/8"	.063"	203ATMD024	20-71-A372-PH
H3582072-4025TL	HARD NOSE 1.33"	20" (50.80cm)	72	3/8"	.058"	208ATMD025	20-42-A272-PH
H3632072-4025TL	HARD NOSE 1.33"	20" (50.80cm)	72	3/8"	.063"	203ATMD025	20-42-A372-PH
H3582072-4176TL	HARD NOSE 1.33"	20" (50.80cm)	72	3/8"	.058"	208ATMD176	20-41-A270-PH
H3632072-4176TL	HARD NOSE 1.33"	20" (50.80cm)	72	3/8"	.063"	203ATMD176	20-41-A372-PH
H3582072-11095TL	HARD NOSE 1.33"	20" (50.80cm)	72	3/8"	.058"	208ATMK095	20-01W-A272-PH
H3632072-11095TL	HARD NOSE 1.33"	20" (50.80cm)	72	3/8"	.063"	203ATMK095	20-01W-A375-PH
H2582078-11041TL	HARD NOSE 1.33"	20" (50.80cm)	78	.325"	.058"	208ATMK041	20-10W-K278-PH
H2632078-11041TL	HARD NOSE 1.33"	20" (50.80cm)	78	.325"	.063"	203ATNK041	20-10W-K378-PH
H2582078-11095TL	HARD NOSE 1.33"	20" (50.80cm)	78	.325"	.058"	208ATMK095	20-01W-K278-PH
H2632078-11095TL	HARD NOSE 1.33"	20" (50.80cm)	78	.325"	.063"	203ATMK095	20-01W-K378-PH
H2582081-4025TL	HARD NOSE 1.33"	20" (50.80cm)	81	.325"	.058"	208ATMD025	20-42-K281-PH
H2632081-4025TL	HARD NOSE 1.33"	20" (50.80cm)	81	.325"	.063"	203ATMD025	20-42-K381-PH
H4632168-5031TL	HARD NOSE 1.33"	21" (53.34cm)	68	.404"	.063"	213ATME031	21-57-B368-PH

Hard Nose Bars continued on page 33



TRILINK® SOLID HARD NOSE BARS (continued)

TRILINK PART NO.	BAR TYPE	BAR LENGTH	DRIVE LINKS	PITCH	GAUGE	OREGON PART NO.	CARLTON PART NO.
H3632172-2083TL	HARD NOSE 1.33"	21" (53.34cm)	72	3/8"	.063"	213ATMB083	21-?-A372-PH
H4632172-5099TL	HARD NOSE 1.33"	21" (53.34cm)	72	.404"	.063"	213ATME099	21-?-B372-PH
H4632268-4009TL	HARD NOSE 1.33"	22" (55.88cm)	68	.404"	.063"	223ATMD009	22-81-B368-PH
H3582276-4009TL	HARD NOSE 1.33"	22" (55.88cm)	76	3/8"	.058"	228ATMD009	22-81-A276-PH
H3632276-4009TL	HARD NOSE 1.33"	22" (55.88cm)	76	3/8"	.063"	223ATMD009	22-81-A376-PH
H3582276-4025TL	HARD NOSE 1.33"	22" (55.88cm)	76	3/8"	.058"	228ATMD025	22-42-A276-PH
H3632276-4025TL	HARD NOSE 1.33"	22" (55.88cm)	76	3/8"	.063"	223ATMD025	22-42-A376-PH
H3582276-11095TL	HARD NOSE 1.33"	22" (55.88cm)	76	3/8"	.058"	228ATMK095	22-01W-A276-PH
H4632372-4009TL	HARD NOSE 1.33"	23" (58.42cm)	72	.404"	.063"	223ATMD009	23-81-B372-PH
H3582380-4009TL	HARD NOSE 1.33"	23" (58.42cm)	80	3/8"	.058"	238ATMD009	23-81-A280-PH
H3632380-4009TL	HARD NOSE 1.33"	23" (58.42cm)	80	3/8"	.063"	233ATMD009	23-81-A380-PH
H3582380-4025TL	HARD NOSE 1.33"	23" (58.42cm)	80	3/8"	.058"	238ATMD025	23-42-A280-PH
H3632380-4025TL	HARD NOSE 1.33"	23" (58.42cm)	80	3/8"	.063"	233ATMD025	23-42-A380-PH
H4632476-4009TL	HARD NOSE 1.33"	24" (60.96cm)	76	.404"	.063"	243ATMD009	24-81-B376-PH
H3582481-4176TL	HARD NOSE 1.33"	24" (60.96cm)	81	3/8"	.058"	248ATMD176	24-41-A281-PH
H3632481-4176TL	HARD NOSE 1.33"	24" (60.96cm)	81	3/8"	.063"	243ATMD176	24-41-A381-PH
H3582481-4196TL	HARD NOSE 1.33"	24" (60.96cm)	81	3/8"	.058"	248ATMD196	24-21-A281-PH
H3632481-4196TL	HARD NOSE 1.33"	24" (60.96cm)	81	3/8"	.063"	243ATMD196	24-21-A381-PH
H3582484-4009TL	HARD NOSE 1.33"	24" (60.96cm)	84	3/8"	.058"	248ATMD009	24-81-A284-PH
H3632484-4009TL	HARD NOSE 1.33"	24" (60.96cm)	84	3/8"	.063"	243ATMD009	24-81-A384-PH
H3582484-4025TL	HARD NOSE 1.33"	24" (60.96cm)	84	3/8"	.058"	248ATMD025	24-42-A284-PH
H3632484-4025TL	HARD NOSE 1.33"	24" (60.96cm)	84	3/8"	.063"	243ATMD025	24-42-A384-PH
H2582490-11095TL	HARD NOSE 1.33"	24" (60.96cm)	90	.325"	.058"	248ATMK095	24-01W-K290-PH
H2632490-11095TL	HARD NOSE 1.33"	24" (60.96cm)	90	.325"	.063"	243ATMK095	24-01W-K390-PH
H4632580-5031TL	HARD NOSE 1.33"	25" (63.50cm)	80	.404"	.063"	253ATME031	25-57-B380-PH
H4632584-5099TL	HARD NOSE 1.33"	25" (63.50cm)	84	.404"	.063"	253ATME099	25-?-B384-PH
H3632592-5099TL	HARD NOSE 1.33"	25" (63.50cm)	92	3/8"	.063"	253ATME099	25-?-A392-PH
H3582891-4025TL	HARD NOSE 1.33"	28" (71.12cm)	91	3/8"	.058"	288ATMD025	28-42-A291-PH
H3582892-4009TL	HARD NOSE 1.33"	28" (71.12cm)	92	3/8"	.058"	288ATMD009	28-81-A292-PH
H3632892-4009TL	HARD NOSE 1.33"	28" (71.12cm)	92	3/8"	.063"	283ATMD009	28-81-A392-PH
H3632892-4025TL	HARD NOSE 1.33"	28" (71.12cm)	92	3/8"	.063"	283ATMD025	28-42-A392-PH
H3632893-4009TL	HARD NOSE 1.33"	28" (71.12cm)	93	3/8"	.063"	283ATMD009	28-81-A393-PH
H4633089-4009TL	HARD NOSE 1.33"	30" (76.20cm)	89	.404"	.063"	303ATMD009	30-81-B389-PH
H4633092-5031TL	HARD NOSE 1.33"	30" (76.20cm)	92	.404"	.063"	303ATME031	30-57-B392-PH
H4633092-5099TL	HARD NOSE 1.33"	30" (76.20cm)	92	.404"	.063"	303ATME099	30-?-B392-PH
H3633097-4025TL	HARD NOSE 1.33"	30" (76.20cm)	97	3/8"	.063"	303ATMD025	30-42-A397-PH
H3583098-4025TL	HARD NOSE 1.33"	30" (76.20cm)	98	3/8"	.058"	308ATMD025	30-42-A298-PH
H36330100-5099TL	HARD NOSE 1.33"	30" (76.20cm)	100	3/8"	.063"	303ATME099	30-?-A3100-PH
H46334100-5099TL	HARD NOSE 1.33"	34" (86.36cm)	100	.404"	.063"	343ATME099	34-?-B3100-PH

Hard Nose Bars continued on page 34

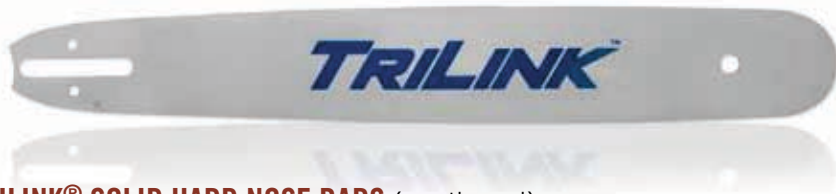

TRILINK® SOLID HARD NOSE BARS (continued)

TRILINK PART NO.	BAR TYPE	BAR LENGTH	DRIVE LINKS	PITCH	GAUGE	OREGON PART NO.	CARLTON PART NO.
H46336104-4025TL	HARD NOSE 1.33"	36" (91.44cm)	104	.404"	.063"	363ATMD025	36-42-B3104-PH
H46336104-5099TL	HARD NOSE 1.33"	36" (91.44cm)	104	.404"	.063"	363ATME099	36-?-B3104-PH
H35836114-4025TL	HARD NOSE 1.33"	36" (91.44cm)	114	3/8"	.058"	358ATMD025	36-42-A2114-PH
H36336114-4025TL	HARD NOSE 1.33"	36" (91.44cm)	114	3/8"	.063"	363ATMD025	36-42-B3114-PH
H36336114-5099TL	HARD NOSE 1.33"	36" (91.44cm)	114	3/8"	.063"	363ATME099	36-A3114-PH
H35836115-4009TL	HARD NOSE 1.33"	36" (91.44cm)	115	3/8"	.058"	358ATMD009	36-81-A2115-PH
H36336115-4009TL	HARD NOSE 1.33"	36" (91.44cm)	115	3/8"	.063"	363ATMD009	36-81-A3115-PH



TRILINK® REPLACEMENT SPROCKET NOSES are a replaceable sprocket nose tip that can be changed as it wears out without having to replace the entire bar. These tips are manufactured for high speed, heavy duty saws and are preferred by the professional and semi-professional cutter. They are made to fit all of our replacement sprocket nose bars.

TRILINK PART NO.	PITCH	GAUGE	NUMBER OF TEETH
RN25010	.325"	.050"	10
RN25810	.325"	.058"	10
RN26310	.325"	.063"	10
RN25012	.325"	.050"	12
RN25812	.325"	.058"	12
RN26312	.325"	.063"	12
RN35009	3/8"	.050"	9
RN35809	3/8"	.058"	9
RN36309	3/8"	.063"	9
RN35011	3/8"	.050"	11
RN35811	3/8"	.058"	11
RN36311	3/8"	.063"	11
RN45810	.404"	.058"	10
RN46310	.404"	.063"	10

1041 | MINI LAMINATE

BAR NUMBER / CHAIN	MOUNT	LENGTH	PITCH	GAUGE	DRIVE LINKS
M1430629-1041TL / 14329TL	1041	06" (15.24cm)	3/8" LP	.043"	29
M1500629-1041TL / 15029TL	1041	06" (15.24cm)	3/8" LP	.050"	29
M1430833-1041TL / 14333TL	1041	08" (20.32cm)	3/8" LP	.043"	33
M1500833-1041TL / 15033TL	1041	08" (20.32cm)	3/8" LP	.050"	33
M1430836-1041TL / 14336TL	1041	08" (20.32cm)	3/8" LP	.043"	36
M1431040-1041TL / 14340TL	1041	10" (25.40cm)	3/8" LP	.043"	40
M1501040-1041TL / 15040TL	1041	10" (25.40cm)	3/8" LP	.050"	40
M1431245-1041TL / 14345TL	1041	12" (30.48cm)	3/8" LP	.043"	45
M1501245-1041TL / 15045TL	1041	12" (30.48cm)	3/8" LP	.050"	45
M1431452-1041TL / 14352TL	1041	14" (35.56cm)	3/8" LP	.043"	52
M1501452-1041TL / 15052TL	1041	14" (35.56cm)	3/8" LP	.050"	52
M1431656-1041TL / 14356TL	1041	16" (40.64cm)	3/8" LP	.043"	56
M1501656-1041TL / 15056TL	1041	16" (40.64cm)	3/8" LP	.050"	56
M1501657-1041TL / 15057TL	1041	16" (40.64cm)	3/8" LP	.050"	57
M1501862-1041TL / 15062TL	1041	18" (45.72cm)	3/8" LP	.050"	62

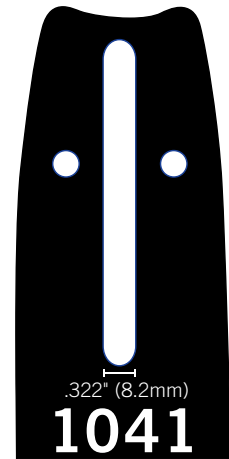

1061 | MINI LAMINATE

BAR NUMBER / CHAIN	MOUNT	LENGTH	PITCH	GAUGE	DRIVE LINKS
M1501248-1061TL / 15048TL	1061	12" (30.48cm)	3/8" LP	.050"	48
M1501453-1061TL / 15053TL	1061	14" (35.56cm)	3/8" LP	.050"	53
M1501659-1061TL / 15059TL	1061	16" (40.64cm)	3/8" LP	.050"	59



1074 | MINI LAMINATE

BAR NUMBER / CHAIN	MOUNT	LENGTH	PITCH	GAUGE	DRIVE LINKS
M1431244-1074TL / 14344TL	1074	12" (30.48cm)	3/8" LP	.043"	44
M1501244-1074TL / 15044TL	1074	12" (30.48cm)	3/8" LP	.050"	44
M1431450-1074TL / 14350TL	1074	14" (35.56cm)	3/8" LP	.043"	50
M1501450-1074TL / 15050TL	1074	14" (35.56cm)	3/8" LP	.050"	50
M1501655-1074TL / 15055TL	1074	16" (40.64cm)	3/8" LP	.050"	55
M1501861-1074TL / 15061TL	1074	18" (45.72cm)	3/8" LP	.050"	61

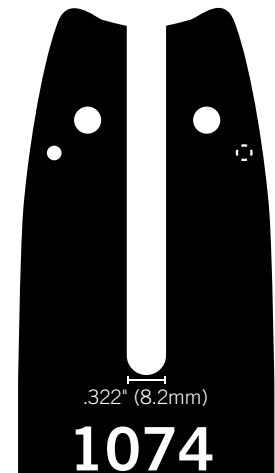

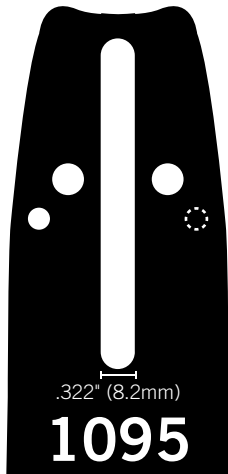

1095 | MINI LAMINATE

BAR NUMBER / CHAIN	MOUNT	LENGTH	PITCH	GAUGE	DRIVE LINKS
M1501245-1095TL / 15045TL	1095	12" (30.48cm)	3/8" LP	.050"	45
M1431452-1095TL / 14352TL	1095	14" (35.56cm)	3/8" LP	.043"	52
M1501452-1095TL / 15052TL	1095	14" (35.56cm)	3/8" LP	.050"	52
M1501656-1095TL / 15056TL	1095	16" (40.64cm)	3/8" LP	.050"	56
M1501862-1095TL / 15062TL	1095	18" (45.72cm)	3/8" LP	.050"	62

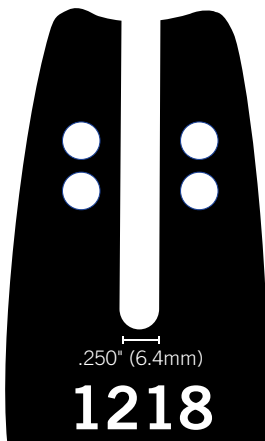

1218 | MINI LAMINATE

BAR NUMBER / CHAIN	MOUNT	LENGTH	PITCH	GAUGE	DRIVE LINKS
M1430833-1218TL / 14333TL	1218	08" (20.32cm)	3/8" LP	.043"	33
M1431039-1218TL / 14339TL	1218	10" (25.40cm)	3/8" LP	.043"	39
M1501039-1218TL / 15039TL	1218	10" (25.40cm)	3/8" LP	.050"	39

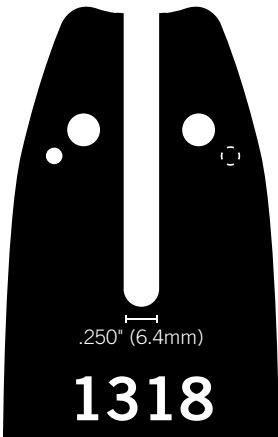

1318 | MINI LAMINATE

BAR NUMBER / CHAIN	MOUNT	LENGTH	PITCH	GAUGE	DRIVE LINKS
M1501039-1318TL / 15039TL	1318	10" (25.40cm)	3/8" LP	.050"	39
M1501244-1318TL / 15044TL	1318	12" (30.48cm)	3/8" LP	.050"	44
M1501449-1318TL / 15049TL	1318	14" (35.56cm)	3/8" LP	.050"	49
M1501450-1318TL / 15050TL	1318	14" (35.56cm)	3/8" LP	.050"	50
M1501654-1318TL / 15054TL	1318	16" (40.64cm)	3/8" LP	.050"	54
M1501655-1318TL / 15055TL	1318	16" (40.64cm)	3/8" LP	.050"	55
M1501860-1318TL / 15060TL	1318	18" (45.72cm)	3/8" LP	.050"	60

11041 | MINI LAMINATE

BAR NUMBER / CHAIN	MOUNT	LENGTH	PITCH	GAUGE	DRIVE LINKS
M1430629-11041TL / 14329TL	11041	06" (15.24cm)	3/8" LP	.043"	29

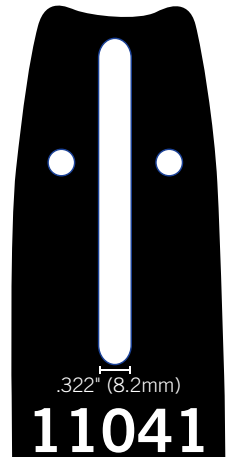

1041 | LAMINATE

BAR NUMBER / CHAIN	MOUNT	LENGTH	PITCH	GAUGE	DRIVE LINKS
L1501040-1041TL / 15040TL	1041	10" (25.40cm)	3/8" LP	.050"	40
L1501245-1041TL / 15045TL	1041	12" (30.48cm)	3/8" LP	.050"	45
L1501452-1041TL / 15052TL	1041	14" (35.56cm)	3/8" LP	.050"	52
L1501656-1041TL / 15056TL	1041	16" (40.64cm)	3/8" LP	.050"	56
L1501657-1041TL / 15057TL	1041	16" (40.64cm)	3/8" LP	.050"	57
L1501862-1041TL / 15062TL	1041	18" (45.72cm)	3/8" LP	.050"	62
L2502078-1041TL / 25078TL	1041	20" (50.80cm)	.325"	.050"	78

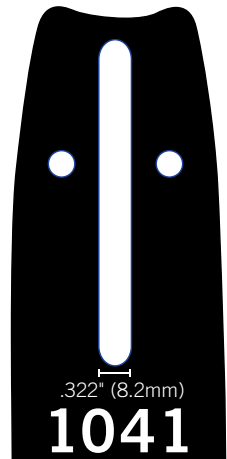

1074 | LAMINATE

BAR NUMBER / CHAIN	MOUNT	LENGTH	PITCH	GAUGE	DRIVE LINKS
L1501244-1074TL / 15044TL	1074	12" (30.48cm)	3/8" LP	.050"	44
L1501450-1074TL / 15050TL	1074	14" (35.56cm)	3/8" LP	.050"	50
L2501662-1074TL / 25062TL	1074	16" (40.64cm)	.325"	.050"	62
L2631662-1074TL / 26362TL	1074	16" (40.64cm)	.325"	.063"	62

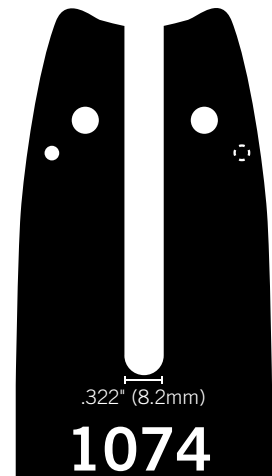

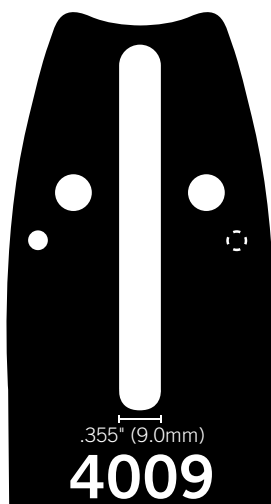

4009 | LAMINATE

BAR NUMBER / CHAIN	MOUNT	LENGTH	PITCH	GAUGE	DRIVE LINKS
L3581556-4009TL / 35856TL	4009	15" (38.10cm)	3/8"	.058"	56
L3631556-4009TL / 36356TL	4009	15" (38.10cm)	3/8"	.063"	56
L3501660-4009TL / 35060TL	4009	16" (40.64cm)	3/8"	.050"	60
L3581660-4009TL / 35860TL	4009	16" (40.64cm)	3/8"	.058"	60
L3501868-4009TL / 35068TL	4009	18" (45.72cm)	3/8"	.050"	68
L3581868-4009TL / 35868TL	4009	18" (45.72cm)	3/8"	.058"	68
L3631868-4009TL / 36368TL	4009	18" (45.72cm)	3/8"	.063"	68
L3502072-4009TL / 35072TL	4009	20" (50.80cm)	3/8"	.050"	72
L3582072-4009TL / 35872TL	4009	20" (50.80cm)	3/8"	.058"	72
L3632072-4009TL / 36372TL	4009	20" (50.80cm)	3/8"	.063"	72

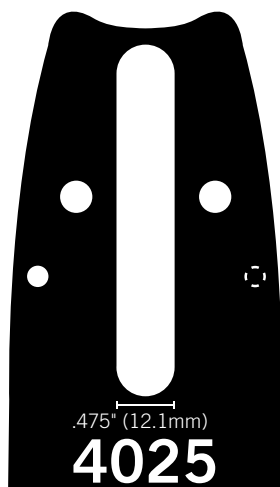

4025 | LAMINATE

BAR NUMBER / CHAIN	MOUNT	LENGTH	PITCH	GAUGE	DRIVE LINKS
L3501556-4025TL / 35056TL	4025	15" (38.10cm)	3/8"	.050"	56
L3581556-4025TL / 35856TL	4025	15" (38.10cm)	3/8"	.058"	56
L2501562-4025TL / 25062TL	4025	15" (38.10cm)	.325"	.050"	62
L2581562-4025TL / 25862TL	4025	15" (38.10cm)	.325"	.058"	62
L2631562-4025TL / 26362TL	4025	15" (38.10cm)	.325"	.063"	62
L3501660-4025TL / 35060TL	4025	16" (40.64cm)	3/8"	.050"	60
L3581660-4025TL / 35860TL	4025	16" (40.64cm)	3/8"	.058"	60
L3631660-4025TL / 36360TL	4025	16" (40.64cm)	3/8"	.063"	60
L2501667-4025TL / 25067TL	4025	16" (40.64cm)	.325"	.050"	67
L2581667-4025TL / 25867TL	4025	16" (40.64cm)	.325"	.058"	67
L2631667-4025TL / 26367TL	4025	16" (40.64cm)	.325"	.063"	67
L3501866-4025TL / 35066TL	4025	18" (45.72cm)	3/8"	.050"	66
L3581866-4025TL / 35866TL	4025	18" (45.72cm)	3/8"	.058"	66
L3631866-4025TL / 36366TL	4025	18" (45.72cm)	3/8"	.063"	66
L2501874-4025TL / 25074TL	4025	18" (45.72cm)	.325"	.050"	74
L2581874-4025TL / 25874TL	4025	18" (45.72cm)	.325"	.058"	74
L2631874-4025TL / 26374TL	4025	18" (45.72cm)	.325"	.063"	74
L3502072-4025TL / 35072TL	4025	20" (50.80cm)	3/8"	.050"	72
L3582072-4025TL / 35872TL	4025	20" (50.80cm)	3/8"	.058"	72
L3632072-4025TL / 36372TL	4025	20" (50.80cm)	3/8"	.063"	72
L2582081-4025TL / 25881TL	4025	20" (50.80cm)	.325"	.058"	81
L2632081-4025TL / 26381TL	4025	20" (50.80cm)	.325"	.063"	81

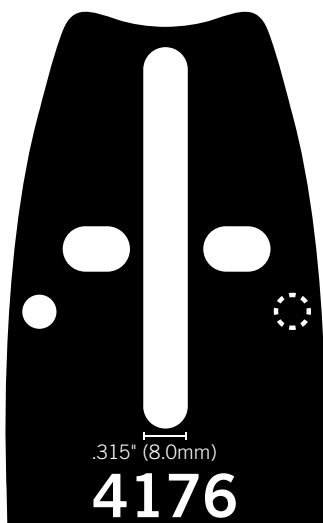

4176 | LAMINATE

BAR NUMBER / CHAIN	MOUNT	LENGTH	PITCH	GAUGE	DRIVE LINKS
L3501660-4176TL / 35060TL	4176	16" (40.64cm)	3/8"	.050"	60
L3581660-4176TL / 35860TL	4176	16" (40.64cm)	3/8"	.058"	60
L1501864-4176TL / 15064TL	4176	18" (45.72cm)	3/8" LP	.050"	64
L3501864-4176TL / 35064TL	4176	18" (45.72cm)	3/8"	.050"	64
L3501866-4176TL / 35066TL	4176	18" (45.72cm)	3/8"	.050"	66
L3581866-4176TL / 35866TL	4176	18" (45.72cm)	3/8"	.058"	66
L2501874-4176TL / 25074TL	4176	18" (45.72cm)	.325"	.050"	74
L3502070-4176TL / 35070TL	4176	20" (50.80cm)	3/8"	.050"	70
L3582070-4176TL / 35870TL	4176	20" (50.80cm)	3/8"	.058"	70
L3632070-4176TL / 36370TL	4176	20" (50.80cm)	3/8"	.063"	70

4196 | LAMINATE

BAR NUMBER / CHAIN	MOUNT	LENGTH	PITCH	GAUGE	DRIVE LINKS
L3501659-4196TL / 35059TL	4196	16" (40.64cm)	3/8"	.050"	59
L3581659-4196TL / 35859TL	4196	16" (40.64cm)	3/8"	.058"	59

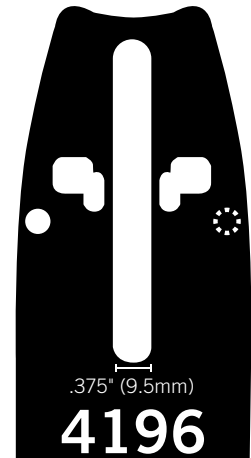

11041 | LAMINATE

BAR NUMBER / CHAIN	MOUNT	LENGTH	PITCH	GAUGE	DRIVE LINKS
L2501564-11041TL / 25064TL	11041	15" (38.10cm)	.325"	.050"	64
L2581564-11041TL / 25864TL	11041	15" (38.10cm)	.325"	.058"	64
L2501666-11041TL / 25066TL	11041	16" (40.64cm)	.325"	.050"	66
L2581666-11041TL / 25866TL	11041	16" (40.64cm)	.325"	.058"	66
L2501872-11041TL / 25072TL	11041	18" (45.72cm)	.325"	.050"	72
L2581872-11041TL / 25872TL	11041	18" (45.72cm)	.325"	.058"	72
L2502078-11041TL / 25078TL	11041	20" (50.80cm)	.325"	.050"	78
L2582078-11041TL / 25878TL	11041	20" (50.80cm)	.325"	.058"	78

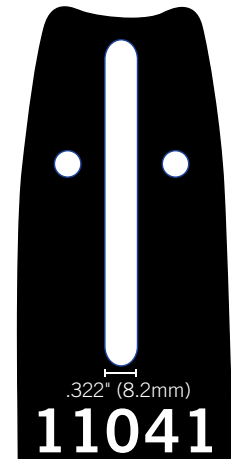

11095 | LAMINATE

BAR NUMBER / CHAIN	MOUNT	LENGTH	PITCH	GAUGE	DRIVE LINKS
L2501356-11095TL / 25056NKTL	11095	13" (33.02cm)	.325"	.050"	56
L2581356-11095TL / 25856NKTL	11095	13" (33.02cm)	.325"	.058"	56
L1501452-11095TI / 15052TL	11095	14" (35.56cm)	3/8" LP	.050"	52
L2501564-11095TL / 25064NKTL	11095	15" (38.10cm)	.325"	.050"	64
L2581564-11095TL / 25864TL	11095	15" (38.10cm)	.325"	.058"	64
L3501659-11095TL / 35059TL	11095	16" (40.64cm)	3/8"	.050"	59
L3501660-11095TL / 35060TL	11095	16" (40.64cm)	3/8"	.050"	60
L3581660-11095TL / 35860TL	11095	16" (40.64cm)	3/8"	.058"	60
L2501666-11095TL / 25066NKTL	11095	16" (40.64cm)	.325"	.050"	66
L2581666-11095TL / 25866TL	11095	16" (40.64cm)	.325"	.058"	66
L3501864-11095TL / 35064TL	11095	18" (45.72cm)	3/8"	.050"	64
L3581864-11095TL / 35864TL	11095	18" (45.72cm)	3/8"	.058"	64
L2501872-11095TL / 25072TL	11095	18" (45.72cm)	.325"	.050"	72
L2581872-11095TL / 25872TL	11095	18" (45.72cm)	.325"	.058"	72
L2502078-11095TL / 25078TL	11095	20" (50.80cm)	.325"	.050"	78
L2582078-11095TL / 25878TL	11095	20" (50.80cm)	.325"	.058"	78

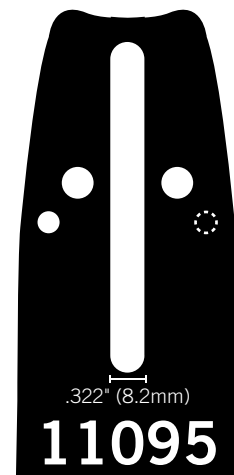

4009 | REPLACEABLE SPROCKET NOSE

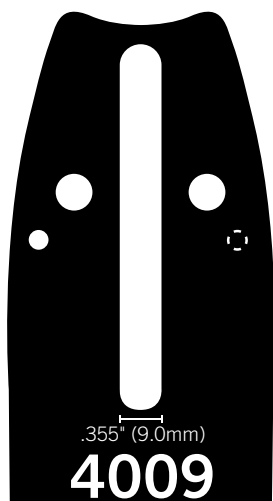

BAR NUMBER / CHAIN	MOUNT	LENGTH	PITCH	GAUGE	DRIVE LINKS
R3581352-4009TL / 35852TL	4009	13" (33.02cm)	3/8"	.058"	52
R3631352-4009TL / 36352TL	4009	13" (33.02cm)	3/8"	.063"	52
R2581359-4009TL / 25859TL	4009	13" (33.02cm)	.325"	.058"	59
R2631359-4009TL / 26359TL	4009	13" (33.02cm)	.325"	.063"	59
R3581556-4009TL / 35856TL	4009	15" (38.10cm)	3/8"	.058"	56
R3631556-4009TL / 36356TL	4009	15" (38.10cm)	3/8"	.063"	56
R3581660-4009TL / 35860TL	4009	16" (40.64cm)	3/8"	.058"	60
R3631660-4009TL / 36360TL	4009	16" (40.64cm)	3/8"	.063"	60
R3581764-4009TL / 35864TL	4009	17" (43.18cm)	3/8"	.058"	64
R3631764-4009TL / 36364TL	4009	17" (43.18cm)	3/8"	.063"	64
R3581868-4009TL / 35868TL	4009	18" (45.72cm)	3/8"	.058"	68
R3631868-4009TL / 36368TL	4009	18" (45.72cm)	3/8"	.063"	68
R4632065-4009TL / 46365TL	4009	20" (50.80cm)	.404"	.063"	65
R3582072-4009TL / 35872TL	4009	20" (50.80cm)	3/8"	.058"	72
R3632072-4009TL / 36372TL	4009	20" (50.80cm)	3/8"	.063"	72
R3582276-4009TL / 35876TL	4009	22" (50.80cm)	3/8"	.058"	76
R3632276-4009TL / 36376TL	4009	22" (50.80cm)	3/8"	.063"	76
R3582380-4009TL / 35880TL	4009	23" (58.42cm)	3/8"	.058"	80
R3632380-4009TL / 36380TL	4009	23" (58.42cm)	3/8"	.063"	80
R4632476-4009TL / 46376TL	4009	24" (60.96cm)	.404"	.063"	76
R3582484-4009TL / 35884TL	4009	24" (60.96cm)	3/8"	.058"	84
R3632484-4009TL / 36384TL	4009	24" (60.96cm)	3/8"	.063"	84
R3502892-4009TL / 35092TL	4009	28" (71.12cm)	3/8"	.050"	92
R3582892-4009TL / 35892TL	4009	28" (71.12cm)	3/8"	.058"	92
R3632892-4009TL / 36392TL	4009	28" (71.12cm)	3/8"	.063"	92
R35836115-4009TL / 358115TL	4009	36" (91.44cm)	3/8"	.058"	115
R36336115-4009TL / 363115TL	4009	36" (91.44cm)	3/8"	.063"	115

4025 | REPLACEABLE SPROCKET NOSE

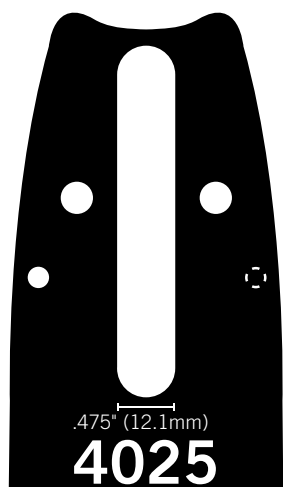

BAR NUMBER / CHAIN	MOUNT	LENGTH	PITCH	GAUGE	DRIVE LINKS
R3581352-4025TL / 35852TL	4025	13" (33.02cm)	3/8"	.058"	52
R3631352-4025TL / 36352TL	4025	13" (33.02cm)	3/8"	.063"	52
R2581359-4025TL / 25859TL	4025	13" (33.02cm)	.325"	.058"	59
R2631359-4025TL / 26359TL	4025	13" (33.02cm)	.325"	.063"	59
R3581556-4025TL / 35856TL	4025	15" (38.10cm)	3/8"	.058"	56
R3631556-4025TL / 36356TL	4025	15" (38.10cm)	3/8"	.063"	56
R3581660-4025TL / 35860TL	4025	16" (40.64cm)	3/8"	.058"	60
R3631660-4025TL / 36360TL	4025	16" (40.64cm)	3/8"	.063"	60
R3581764-4025TL / 35864TL	4025	17" (43.18cm)	3/8"	.058"	64
R3631764-4025TL / 36364TL	4025	17" (43.18cm)	3/8"	.063"	64
R3581866-4025TL / 35866TL	4025	18" (45.72cm)	3/8"	.058"	66
R3631866-4025TL / 36366TL	4025	18" (45.72cm)	3/8"	.063"	66
R2581874-4025TL / 25874TL	4025	18" (45.72cm)	.325"	.058"	74
R2631874-4025TL / 26374TL	4025	18" (45.72cm)	.325"	.063"	74
R3582072-4025TL / 35872TL	4025	20" (50.80cm)	3/8"	.058"	72
R3632072-4025TL / 36372TL	4025	20" (50.80cm)	3/8"	.063"	72
R2582081-4025TL / 25881TL	4025	20" (50.80cm)	.325"	.058"	81
R2632081-4025TL / 26381TL	4025	20" (50.80cm)	.325"	.063"	81
R3582276-4025TL / 35876TL	4025	22" (55.88cm)	3/8"	.058"	76
R3632276-4025TL / 36376TL	4025	22" (55.88cm)	3/8"	.063"	76
R3582380-4025TL / 35880TL	4025	23" (58.42cm)	3/8"	.058"	80
R3632380-4025TL / 36380TL	4025	23" (58.42cm)	3/8"	.063"	80
R3582484-4025TL / 35884TL	4025	24" (60.96cm)	3/8"	.058"	84
R3632484-4025TL / 36384TL	4025	24" (60.96cm)	3/8"	.063"	84
R3582891-4025TL / 35891TL	4025	28" (71.12cm)	3/8"	.058"	91
R3632892-4025TL / 36392TL	4025	28" (71.12cm)	3/8"	.063"	92
R3583098-4025TL / 35898TL	4025	30" (76.20cm)	3/8"	.058"	98
R3633098-4025TL / 36398TL	4025	30" (76.20cm)	3/8"	.063"	98
R35836114-4025TL / 358114TL	4025	36" (91.44cm)	3/8"	.058"	114
R36336114-4025TL / 363114TL	4025	36" (91.44cm)	3/8"	.063"	114

4176 | REPLACEABLE SPROCKET NOSE

BAR NUMBER / CHAIN	MOUNT	LENGTH	PITCH	GAUGE	DRIVE LINKS
R3581660-4176TL / 35860TL	4176	16" (40.64cm)	3/8"	.058"	60
R3631660-4176TL / 36360TL	4176	16" (40.64cm)	3/8"	.063"	60
R3582070-4176TL / 35870TL	4176	20" (50.80cm)	3/8"	.058"	70
R3632070-4176TL / 36370TL	4176	20" (50.80cm)	3/8"	.063"	70
R3582072-4176TL / 35872TL	4176	20" (50.80cm)	3/8"	.058"	72
R3632072-4176TL / 36372TL	4176	20" (50.80cm)	3/8"	.063"	72
R3582481-4176TL / 35881TL	4176	24" (60.96cm)	3/8"	.058"	81
R3632481-4176TL / 36381TL	4176	24" (60.96cm)	3/8"	.063"	81

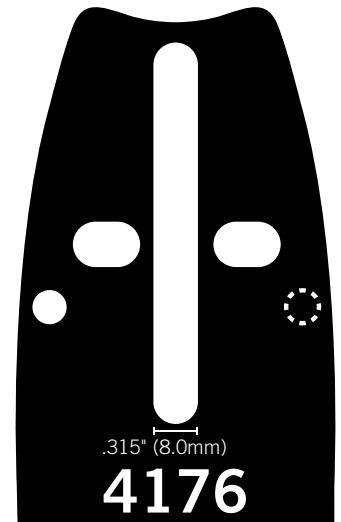

4196 | REPLACEABLE SPROCKET NOSE

BAR NUMBER / CHAIN	MOUNT	LENGTH	PITCH	GAUGE	DRIVE LINKS
R3581660-4196TL / 35860TL	4196	16" (40.64cm)	3/8"	.058"	60
R3631660-4196TL / 36360TL	4196	16" (40.64cm)	3/8"	.063"	60
R3582070-4196TL / 35870TL	4196	20" (50.80cm)	3/8"	.058"	70
R3632070-4196TL / 36370TL	4196	20" (50.80cm)	3/8"	.063"	70
R3582481-4196TL / 35881TL	4196	24" (60.96cm)	3/8"	.058"	81
R3632481-4196TL / 36381TL	4196	24" (60.96cm)	3/8"	.063"	81

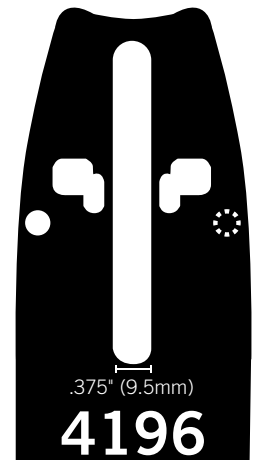

5031 | REPLACEABLE SPROCKET NOSE

BAR NUMBER / CHAIN	MOUNT	LENGTH	PITCH	GAUGE	DRIVE LINKS
R4632168-5031TL / 46368TL	5031	21" (53.34cm)	.404"	.063"	68
R4632580-5031TL / 46380TL	5031	25" (63.50cm)	.404"	.063"	80
R4633092-5031TL / 46392TL	5031	30" (76.20cm)	.404"	.063"	92

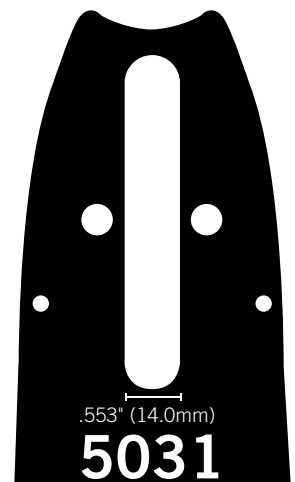

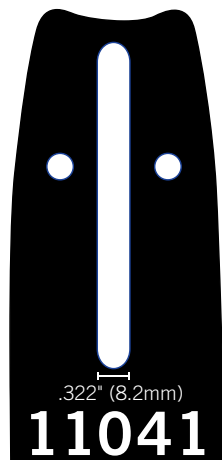

11041 | REPLACEABLE SPROCKET NOSE

BAR NUMBER / CHAIN	MOUNT	LENGTH	PITCH	GAUGE	DRIVE LINKS
R2581872-11041TL / 25872TL	11041	18" (45.72cm)	.325"	.058"	72
R2631872-11041TL / 26372TL	11041	18" (45.72cm)	.325"	.063"	72

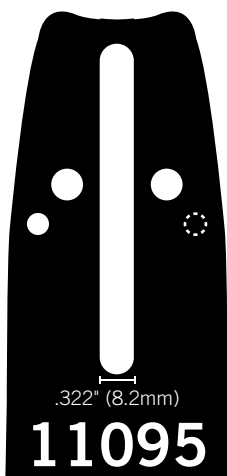

11095 | REPLACEABLE SPROCKET NOSE

BAR NUMBER / CHAIN	MOUNT	LENGTH	PITCH	GAUGE	DRIVE LINKS
R3581556-11095TL / 35856TL	11095	15" (38.10cm)	3/8"	.058"	56
R3631556-11095TL / 36356TL	11095	15" (38.10cm)	3/8"	.063"	56
R2581564-11095TL / 25864TL	11095	15" (38.10cm)	.325"	.058"	64
R2631564-11095TL / 26364TL	11095	15" (38.10cm)	.325"	.063"	64
R3581659-11095TL / 35859TL	11095	16" (40.64cm)	3/8"	.058"	59
R3631659-11095TL / 36359TL	11095	16" (40.64cm)	3/8"	.063"	59
R2581666-11095TL / 25866TL	11095	16" (40.64cm)	.325"	.058"	66
R2631666-11095TL / 26366TL	11095	16" (40.64cm)	.325"	.063"	66
R3581868-11095TL / 35868TL	11095	18" (45.72cm)	3/8"	.058"	68
R3631868-11095TL / 36368TL	11095	18" (45.72cm)	3/8"	.063"	68
R2581872-11095TL / 25872TL	11095	18" (45.72cm)	.325"	.058"	72
R2631872-11095TL / 26372TL	11095	18" (45.72cm)	.325"	.063"	72
R3582072-11095TL / 35872TL	11095	20" (50.80cm)	3/8"	.058"	72
R3632072-11095TL / 36372TL	11095	20" (50.80cm)	3/8"	.063"	72
R2582078-11095TL / 25878TL	11095	20" (50.80cm)	.325"	.058"	78
R2632078-11095TL / 26378TL	11095	20" (50.80cm)	.325"	.063"	78
R2582490-11095TL / 25890TL	11095	24" (60.96cm)	.325"	.058"	90
R2632490-11095TL / 26390TL	11095	24" (60.96cm)	.325"	.063"	90

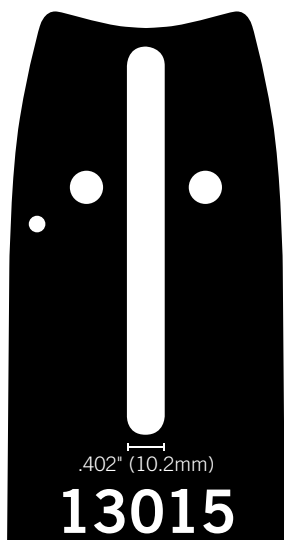

13015 | REPLACEABLE SPROCKET NOSE

BAR NUMBER / CHAIN	MOUNT	LENGTH	PITCH	GAUGE	DRIVE LINKS
R4632062-13015TL / 46362TL	13015	20" (50.80cm)	.404"	.063"	62

1041 | SOLID HARD NOSE

BAR NUMBER / CHAIN	MOUNT	LENGTH	PITCH	GAUGE	DRIVE LINKS
H1581245-1041TL / 15845TL	1041	12" (30.48cm)	3/8" LP	.058"	45
H1581453-1041TL / 15853TL	1041	14" (35.36cm)	3/8" LP	.058"	53
H2581664-1041TL / 25864TL	1041	16" (40.64cm)	.325"	.058"	64
H2631664-1041TL / 26364TL	1041	16" (40.64cm)	.325"	.063"	64

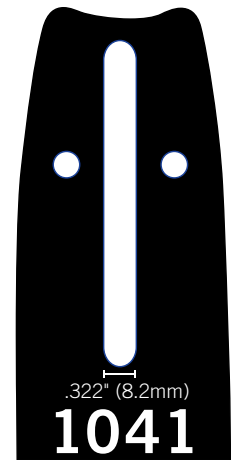

1074 | SOLID HARD NOSE

BAR NUMBER / CHAIN	MOUNT	LENGTH	PITCH	GAUGE	DRIVE LINKS
H1581655-1074TL / 15855TL	1074	16" (40.64cm)	3/8" LP	.058"	55
H3581860-1074TL / 35860TL	1074	18" (45.72cm)	3/8"	.058"	60
H3582070-1074TL / 35870TL	1074	20" (50.80cm)	3/8"	.058"	70

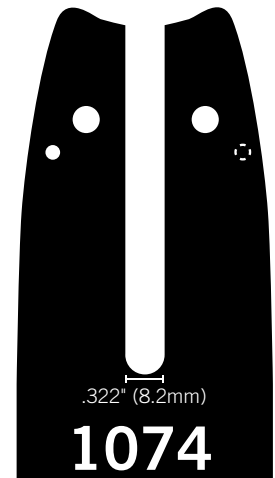

2083 | SOLID HARD NOSE

BAR NUMBER / CHAIN	MOUNT	LENGTH	PITCH	GAUGE	DRIVE LINKS
H3632172 - 2083TL / 36372TL	2083	21" (53.34cm)	3/8"	.063"	72

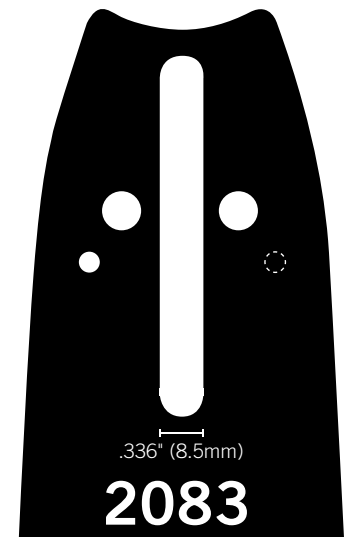

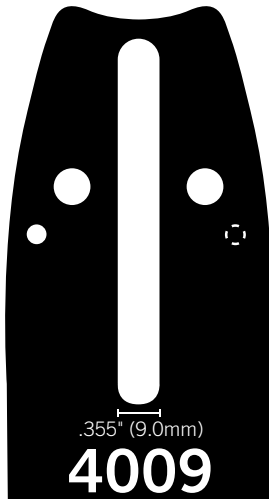

4009 | SOLID HARD NOSE

BAR NUMBER / CHAIN	MOUNT	LENGTH	PITCH	GAUGE	DRIVE LINKS
H3581352-4009TL / 35852TL	4009	13" (33.02cm)	3/8"	.058"	52
H3631352-4009TL / 36352TL	4009	13" (33.02cm)	3/8"	.063"	52
H2631359-4009TL / 26359TL	4009	13" (33.02cm)	.325"	.063"	59
H3581556-4009TL / 35856TL	4009	15" (38.10cm)	3/8"	.058"	56
H3631556-4009TL / 36356TL	4009	15" (38.10cm)	3/8"	.063"	56
H3581660-4009TL / 35860TL	4009	16" (40.64cm)	3/8"	.058"	60
H3631660-4009TL / 36360TL	4009	16" (40.64cm)	3/8"	.063"	60
H3581764-4009TL / 35864TL	4009	17" (43.18cm)	3/8"	.058"	64
H3631764-4009TL / 36364TL	4009	17" (43.18cm)	3/8"	.063"	64
H3581868-4009TL / 35868TL	4009	18" (45.72cm)	3/8"	.058"	68
H3631868-4009TL / 36368TL	4009	18" (45.72cm)	3/8"	.063"	68
H4632065-4009TL / 46365TL	4009	20" (50.80cm)	.404"	.063"	65
H3582072-4009TL / 35872TL	4009	20" (50.80cm)	3/8"	.058"	72
H3632072-4009TL / 36372TL	4009	20" (50.80cm)	3/8"	.063"	72
H4632268-4009TL / 46368TL	4009	22" (55.88cm)	.404"	.063"	68
H3582276-4009TL / 35876TL	4009	22" (55.88cm)	3/8"	.058"	76
H3632276-4009TL / 36376TL	4009	22" (55.88cm)	3/8"	.063"	76
H4632372-4009TL / 46372TL	4009	23" (58.42cm)	.404"	.063"	72
H3582380-4009TL / 35880TL	4009	23" (58.42cm)	3/8"	.058"	80
H3632380-4009TL / 36380TL	4009	23" (58.42cm)	3/8"	.063"	80
H4632476-4009TL / 46376TL	4009	24" (60.96cm)	.404"	.063"	76
H3582484-4009TL / 35884TL	4009	24" (60.96cm)	3/8"	.058"	84
H3632484-4009TL / 36384TL	4009	24" (60.96cm)	3/8"	.063"	84
H3582892-4009TL / 35892TL	4009	28" (71.12cm)	3/8"	.058"	92
H3632892-4009TL / 36392TL	4009	28" (71.12cm)	3/8"	.063"	92
H3632893-4009TL / 36393TL	4009	28" (71.12cm)	3/8"	.063"	93
H4633089-4009TL / 46389TL	4009	30" (76.20cm)	.404"	.063"	89
H35836115-4009TL / 358115TL	4009	36" (91.44cm)	3/8"	.058"	115
H36336115-4009TL / 363115TL	4009	36" (91.44cm)	3/8"	.063"	115

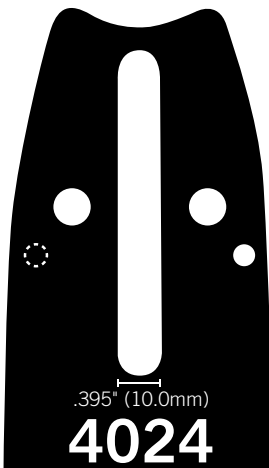

4024 | SOLID HARD NOSE

BAR NUMBER / CHAIN	MOUNT	LENGTH	PITCH	GAUGE	DRIVE LINKS
H3632072-4024TL / 36372TL	4024	20" (50.80cm)	3/8"	.063"	72

4025 | SOLID HARD NOSE

BAR NUMBER / CHAIN	MOUNT	LENGTH	PITCH	GAUGE	DRIVE LINKS
H3581352-4025TL / 35852TL	4025	13" (33.02cm)	3/8"	.058"	52
H3631352-4025TL / 36352TL	4025	13" (33.02cm)	3/8"	.063"	52
H2581359-4025TL / 25859TL	4025	13" (33.02cm)	.325"	.058"	59
H3581556-4025TL / 35856TL	4025	15" (38.10cm)	3/8"	.058"	56
H3631556-4025TL / 36356TL	4025	15" (38.10cm)	3/8"	.063"	56
H3581660-4025TL / 35860TL	4025	16" (40.64cm)	3/8"	.058"	60
H3631660-4025TL / 36360TL	4025	16" (40.64cm)	3/8"	.063"	60
H3581764-4025TL / 35864TL	4025	17" (43.18cm)	3/8"	.058"	64
H3631764-4025TL / 36364TL	4025	17" (43.18cm)	3/8"	.063"	64
H3581866-4025TL / 35866TL	4025	18" (45.72cm)	3/8"	.058"	66
H3631866-4025TL / 36366TL	4025	18" (45.72cm)	3/8"	.063"	66
H2581874-4025TL / 25874TL	4025	18" (45.72cm)	.325"	.058"	74
H2631874-4025TL / 26374TL	4025	18" (45.72cm)	.325"	.063"	74
H3582072-4025TL / 35872TL	4025	20" (50.80cm)	3/8"	.058"	72
H3632072-4025TL / 36372TL	4025	20" (50.80cm)	3/8"	.063"	72
H2582081-4025TL / 25881TL	4025	20" (50.80cm)	.325"	.058"	81
H2632081-4025TL / 26381TL	4025	20" (50.80cm)	.325"	.063"	81
H3582276-4025TL / 35876TL	4025	22" (55.88cm)	3/8"	.058"	76
H3632276-4025TL / 36376TL	4025	22" (55.88cm)	3/8"	.063"	76
H3582380-4025TL / 35880TL	4025	23" (58.42cm)	3/8"	.058"	80
H3632380-4025TL / 36380TL	4025	23" (58.42cm)	3/8"	.063"	80
H3582484-4025TL / 35884TL	4025	24" (60.96cm)	3/8"	.058"	84
H3632484-4025TL / 36384TL	4025	24" (60.96cm)	3/8"	.063"	84
H3582891-4025TL / 35891TL	4025	28" (71.12cm)	3/8"	.058"	91
H3632892-4025TL / 36392TL	4025	28" (71.12cm)	3/8"	.063"	92
H3633097-4025TL / 36397TL	4025	30" (76.20cm)	3/8"	.063"	97
H3583698-4025TL / 35898TL	4025	36" (91.44cm)	3/8"	.058"	98
H46336104-4025TL / 463104TL	4025	36" (91.44cm)	.404"	.063"	104
H35836114-4025TL / 358114TL	4025	36" (91.44cm)	3/8"	.058"	114
H36336114-4025TL / 363114TL	4025	36" (91.44cm)	3/8"	.063"	114

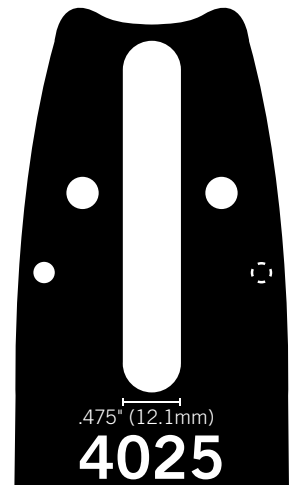

4176 | SOLID HARD NOSE

BAR NUMBER / CHAIN	MOUNT	LENGTH	PITCH	GAUGE	DRIVE LINKS
H3581659-4176TL / 35859TL	4176	16" (40.64cm)	3/8"	.058"	59
H3631659-4176TL / 36359TL	4176	16" (40.64cm)	3/8"	.063"	59
H3581660-4176TL / 35860TL	4176	16" (40.64cm)	3/8"	.058"	60
H3631660-4176TL / 36360TL	4176	16" (40.64cm)	3/8"	.063"	60
H3582070-4176TL / 35870TL	4176	20" (50.80cm)	3/8"	.058"	70
H3632070-4176TL / 36370TL	4176	20" (50.80cm)	3/8"	.063"	70
H3582072-4176TL / 35872TL	4176	20" (50.80cm)	3/8"	.058"	72
H3632072-4176TL / 36372TL	4176	20" (50.80cm)	3/8"	.063"	72
H3582481-4176TL / 35881TL	4176	24" (60.96cm)	3/8"	.058"	81
H3632481-4176TL / 36381TL	4176	24" (60.96cm)	3/8"	.063"	81

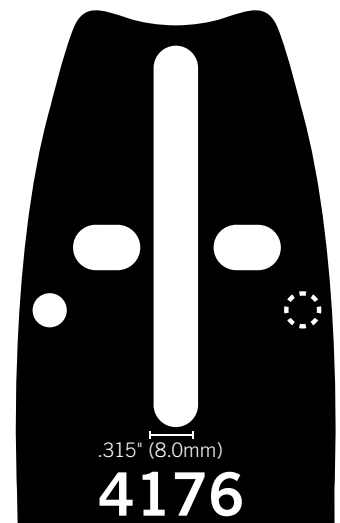

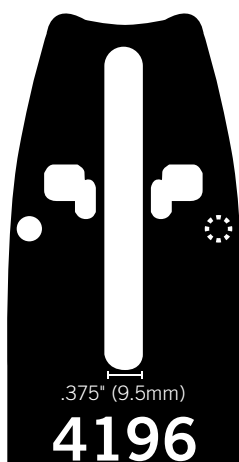

4196 | SOLID HARD NOSE

BAR NUMBER / CHAIN	MOUNT	LENGTH	PITCH	GAUGE	DRIVE LINKS
H3581660-4196TL / 35860TL	4196	16" (40.64cm)	3/8"	.058"	60
H3631660-4196TL / 36360TL	4196	16" (40.64cm)	3/8"	.063"	60
H3581864-4196TL / 35864TL	4196	18" (45.72cm)	3/8"	.058"	64
H3631864-4196TL / 36364TL	4196	18" (45.72cm)	3/8"	.063"	64
H3582070-4196TL / 35870TL	4196	20" (50.80cm)	3/8"	.058"	70
H3632070-4196TL / 36370TL	4196	20" (50.80cm)	3/8"	.063"	70
H3582481-4196TL / 35881TL	4196	24" (60.96cm)	3/8"	.058"	81
H3632481-4196TL / 36381TL	4196	24" (60.96cm)	3/8"	.063"	81

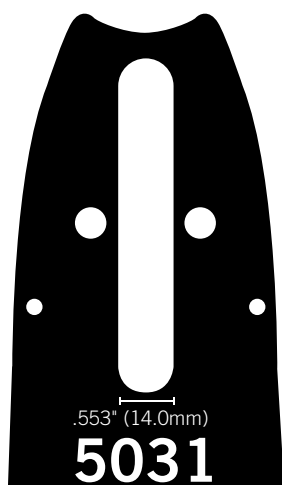

5031 | SOLID HARD NOSE

BAR NUMBER / CHAIN	MOUNT	LENGTH	PITCH	GAUGE	DRIVE LINKS
H4632168-5031TL / 46368TL	5031	21" (53.34cm)	.404"	.063"	68
H4632580-5031TL / 46380TL	5031	25" (63.50cm)	.404"	.063"	80
H4633092-5031TL / 46392TL	5031	30" (76.20cm)	.404"	.063"	92

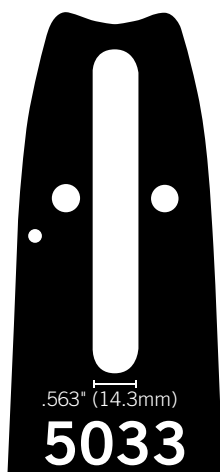

5033 | SOLID HARD NOSE

BAR NUMBER / CHAIN	MOUNT	LENGTH	PITCH	GAUGE	DRIVE LINKS
H4631761-5033TL / 46361TL	5033	17" (43.18cm)	.404"	.063"	61

5099 | SOLID HARD NOSE

BAR NUMBER / CHAIN	MOUNT	LENGTH	PITCH	GAUGE	DRIVE LINKS
H4631760-5099TL / 46360TL	5099	17" (43.18cm)	.404"	.063"	60
H4632172-5099TL / 46372TL	5099	21" (53.34cm)	.404"	.063"	72
H4632584-5099TL / 46384TL	5099	25" (63.50cm)	.404"	.063"	84
H3632592-5099TL / 36392TL	5099	25" (63.50cm)	3/8"	.063"	92
H4633092-5099TL / 46392TL	5099	30" (76.20cm)	.404"	.063"	92
H36330100-5099TL / 363100TL	5099	30" (76.20cm)	3/8"	.063"	100
H46334100-5099TL / 463100TL	5099	34" (86.36cm)	.404"	.063"	100
H46336104-5099TL / 463104TL	5099	36" (91.44cm)	.404"	.063"	104
H36336114-5099TL / 363114TL	5099	36" (91.44cm)	3/8"	.063"	114

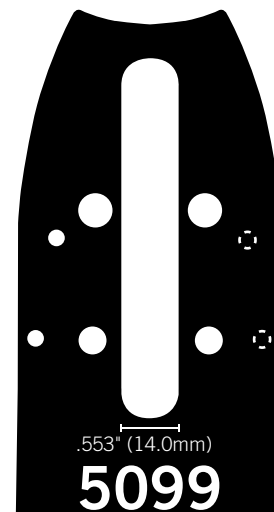

11041 | SOLID HARD NOSE

BAR NUMBER / CHAIN	MOUNT	LENGTH	PITCH	GAUGE	DRIVE LINKS
H2581872-11041TL / 25872TL	11041	18" (45.72cm)	.325"	.058"	72
H2631872-11041TL / 26372TL	11041	18" (45.72cm)	.325"	.063"	72
H2582078-11041TL / 25878TL	11041	20" (50.80cm)	.325"	.058"	78
H2632078-11041TL / 26378TL	11041	20" (50.80cm)	.325"	.063"	78

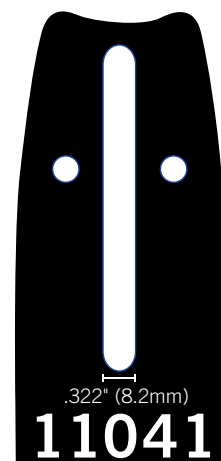

11095 | SOLID HARD NOSE

BAR NUMBER / CHAIN	MOUNT	LENGTH	PITCH	GAUGE	DRIVE LINKS
H3581556-11095TL / 35856TL	11095	15" (38.10cm)	3/8"	.058"	56
H3631556-11095TL / 36356TL	11095	15" (38.10cm)	3/8"	.063"	56
H2581564-11095TL / 25864TL	11095	15" (38.10cm)	.325"	.058"	64
H2631564-11095TL / 26364TL	11095	15" (38.10cm)	.325"	.063"	64
H3581659-11095TL / 35859TL	11095	16" (40.64cm)	3/8"	.058"	59
H3631659-11095TL / 36359TL	11095	16" (40.64cm)	3/8"	.063"	59
H3581660-11095TL / 35860TL	11095	16" (40.64cm)	3/8"	.058"	60
H3631660-11095TL / 36360TL	11095	16" (40.64cm)	3/8"	.063"	60
H2581666-11095TL / 25866TL	11095	16" (40.64cm)	.325"	.058"	66
H2631666-11095TL / 26366TL	11095	16" (40.64cm)	.325"	.063"	66
H3581864-11095TL / 35864TL	11095	18" (45.72cm)	3/8"	.058"	64
H3631864-11095TL / 36364TL	11095	18" (45.72cm)	3/8"	.063"	64
H3581868-11095TL / 35868TL	11095	18" (45.72cm)	3/8"	.058"	68
H3631868-11095TL / 36368TL	11095	18" (45.72cm)	3/8"	.063"	68
H2631872-11095TL / 26372TL	11095	18" (45.72cm)	.325"	.063"	72
H3582072-11095TL / 35872TL	11095	20" (50.80cm)	3/8"	.058"	72
H3632072-11095TL / 36372TL	11095	20" (50.80cm)	3/8"	.063"	72
H2582078-11095TL / 25878TL	11095	20" (50.80cm)	.325"	.058"	78
H2632078-11095TL / 26378TL	11095	20" (50.80cm)	.325"	.063"	78
H3582276-11095TL / 35876TL	11095	22" (55.88cm)	3/8"	.058"	76
H2582490-11095TL / 25890TL	11095	24" (60.96cm)	.325"	.058"	90
H2632490-11095TL / 26390TL	11095	24" (60.96cm)	.325"	.063"	90

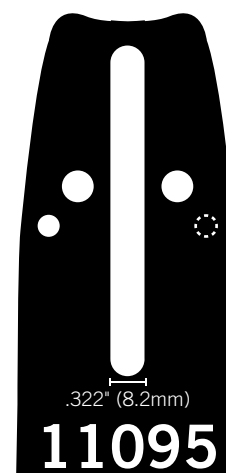



CUTTING LENGTH	DRIVE LINKS	PITCH	GAUGE	CHAIN PART NUMBER	MINI LAMINATE	LAMINATED SPROCKET NOSE	REPLACEABLE SPROCKET NOSE	HARD NOSE
----------------	-------------	-------	-------	-------------------	---------------	-------------------------	---------------------------	-----------

BLACK & DECKER

MODELS: PP2018, CSC818, LH1600, LOG HOG

8" (20.32cm)	33	3/8" LP NK	.043" (1,1mm)	14333TL	M1430833-1218TL			
--------------	----	------------	---------------	---------	-----------------	--	--	--

CORONA

MODELS: CLIPPER POLE SAW

10" (25.40cm)	40	3/8" LP	.050" (1,3mm)	15040TL	M1501040-1218TL			
---------------	----	---------	---------------	---------	-----------------	--	--	--

DOLMAR

MODELS: 109, 110, 111, 115, 115I, PS-460, PS-510, PS-540, PS-5100S, PS-5105, PS-5105H

13" (33.02cm)	56	.325" NK	.050" (1,3mm)	25056NKTL		L2501356-11095TL		
13" (33.02cm)	56	.325"	.058" (1,5mm)	25856TL		L2581356-11095TL		
15" (38.10cm)	64	.325" NK	.050" (1,3mm)	25064NKTL		L2501564-11095TL		
15" (38.10cm)	64	.325"	.058" (1,5mm)	25864TL		L2581564-11095TL	R2581564-11095TL	H2581564-11095TL
16" (40.64cm)	66	.325" NK	.050" (1,3mm)	25066NKTL		L2501666-11095TL		
16" (40.64cm)	66	.325"	.050" (1,3mm)	25066TL		L2501666-11095TL		
16" (40.64cm)	66	.325"	.058" (1,5mm)	25866TL		L2581666-11095TL	R2581666-11095TL	H2581666-11095TL
18" (45.72cm)	72	.325" NK	.050" (1,3mm)	25072NKTL		L2501872-11095TL		
18" (45.72cm)	72	.325"	.050" (1,3mm)	25072TL		L2501872-11095TL		
18" (45.72cm)	72	.325"	.058" (1,5mm)	25872TL		L2581872-11095TL	R2581872-11095TL	
20" (50.80cm)	78	.325"	.058" (1,5mm)	25878TL			R2582078-11095TL	H2582078-11095TL

MODELS: 100, 101, 102, 103, 104, 105, 108, ES-161, ES-171, ES-173A, PS-34, PS-45, PS-340, PS-341, PS-350, PS-400, PS-401, PS-420, PS-3300TH, PS-3410TH

12" (30.48cm)	45	3/8" LP NK	.043" (1,1mm)	14345NKTL	M1431245-1041TL			
12" (30.48cm)	45	3/8" LP	.050" (1,3mm)	15045TL	M1501245-1041TL			
14" (35.56cm)	52	3/8" LP NK	.043" (1,1mm)	14352NKTL	M1431452-1041TL			
14" (35.56cm)	52	3/8" LP	.050" (1,3mm)	15052TL	M1501452-1041TL			
16" (40.64cm)	56	3/8" LP NK	.043" (1,1mm)	14356NKTL	M1431656-1041TL			
16" (40.64cm)	56	3/8" LP	.050" (1,3mm)	15056TL	M1501656-1041TL			
18" (45.72cm)	62	3/8" LP	.050" (1,3mm)	15062TL	M1501862-1041TL			

MODELS: PS-351, PS-421

12" (30.48cm)	45	3/8" LP	.050" (1,3mm)	15045TL	M1501245-1041TL			
14" (35.56cm)	52	3/8" LP	.050" (1,3mm)	15052TL	M1501452-1041TL			
15" (38.10cm)	64	.325" NK	.050" (1,3mm)	25064NKTL		L2501564-11041TL		
16" (40.64cm)	56	3/8" LP	.050" (1,3mm)	15056TL	M1501656-1041TL			
18" (45.72cm)	72	.325"	.050" (1,3mm)	25072NKTL		L2501872-11041TL		

MODELS: 110, 111, 112, 113, 114, 115, 116, 116SI, 117, 118, 119, PS-460, PS-510, PS-450, PS-5100S, PS-5105, PS-6000I

16" (40.64cm)	59	3/8"	.050" (1,3mm)	35059TL		L3501659-11095TL		
16" (40.64cm)	59	3/8"	.058" (1,5mm)	35859TL			R3581659-11095TL	H3581659-11095TL
16" (40.64cm)	60	3/8"	.050" (1,3mm)	35060TL		L3501660-11095TL		
16" (40.64cm)	60	3/8"	.058" (1,5mm)	35860TL		L3581660-11095TL		H3581660-11095TL
18" (45.72cm)	64	3/8"	.050" (1,3mm)	35064TL		L3501864-11095TL		
18" (45.72cm)	64	3/8"	.058" (1,5mm)	35864TL		L3581864-11095TL		H3581864-11095TL
18" (45.72cm)	68	3/8"	.058" (1,5mm)	35868TL			R3581868-11095TL	H3581868-11095TL
20" (50.80cm)	72	3/8"	.058" (1,5mm)	35872TL			R3582072-11095TL	H3582072-11095TL

DOLMAR continued on page 49

NOTE: Low kickback requirements in the ANSI standard apply to saw models less than 3.8 cubic inches (62cc). Low kickback performance requirements in the ANSI standard do not apply to saws larger than 3.8 cubic inches.



CUTTING LENGTH	DRIVE LINKS	PITCH	GAUGE	CHAIN PART NUMBER	MINI LAMINATE	LAMINATED SPROCKET NOSE	REPLACEABLE SPROCKET NOSE	HARD NOSE
----------------	-------------	-------	-------	-------------------	---------------	-------------------------	---------------------------	-----------

DOLMAR (cont.)

MODELS: 120, 120 SUPER, 120SI, PS-6800I

16" (40.64cm)	59	3/8"	.050" (1,3mm)	35059TL		L3501659-11095TL		
16" (40.64cm)	59	3/8"	.058" (1,5mm)	35859TL			R3581659-11095TL	H3581659-11095TL
16" (40.64cm)	60	3/8"	.050" (1,3mm)	35060TL		L3501660-11095TL		
16" (40.64cm)	60	3/8"	.058" (1,5mm)	35860TL		L3581660-11095TL	R3581660-11095TL	H3581660-11095TL
18" (45.72cm)	64	3/8"	.050" (1,3mm)	35064TL		L3501864-11095TL		
18" (45.72cm)	64	3/8"	.058" (1,5mm)	35864TL		L3581864-11095TL		H3581864-11095TL
18" (45.72cm)	68	3/8"	.058" (1,5mm)	35868TL			R3581868-11095TL	H3581868-11095TL
20" (50.80cm)	72	3/8"	.058" (1,5mm)	35872TL			R3582072-11095TL	H3582072-11095TL

MODELS: PS-6400, PS-6400H, PS-6400W, PS-7300, PS-7300H, PS-7300W, PS-7900, PS-7900H, PS-7900W, PS-9000, PS-9010, PS-9010FL

16" (40.64cm)	60	3/8"	.050" (1,3mm)	35060TL		L3501660-4009TL		
16" (40.64cm)	60	3/8"	.058" (1,5mm)	35860TL		L3581660-4009TL	R3581660-4009TL	H3581660-4009TL
18" (45.72cm)	68	3/8"	.050" (1,3mm)	35068TL		L3501868-4009TL		
18" (45.72cm)	68	3/8"	.058" (1,5mm)	35868TL		L3581868-4009TL	R3581868-4009TL	H3581868-4009TL
20" (50.80cm)	72	3/8"	.050" (1,3mm)	35072TL		L3502072-4009TL		
20" (50.80cm)	72	3/8"	.058" (1,5mm)	35872TL		L3582072-4009TL	R3582072-4009TL	H3582072-4009TL
20" (50.80cm)	72	3/8"	.063" (1,6mm)	36372TL		L3632072-4009TL	R3632072-4009TL	H3632072-4009TL
24" (60.96cm)	84	3/8"	.058" (1,5mm)	35884TL			R3582484-4009TL	H3582484-4009TL
24" (60.96cm)	84	3/8"	.063" (1,6mm)	36384TL			R3632484-4009TL	H3632484-4009TL
28" (71.12cm)	92	3/8"	.058" (1,5mm)	35892TL			R3582892-4009TL	H3582892-4009TL
28" (71.12cm)	92	3/8"	.063" (1,6mm)	36392TL			R3632892-4009TL	H3632892-4009TL
28" (71.12cm)	93	3/8"	.063" (1,6mm)	36393TL				H3632893-4009TL
36" (91.44cm)	115	3/8"	.058" (1,5mm)	358115TL			R35836115-4009TL	H35836115-4009TL
36" (91.44cm)	115	3/8"	.063" (1,6mm)	363115TL			R36336115-4009TL	H36336115-4009TL

MODELS: PS-9000, PS-9010, PS-9010FL

20" (50.80cm)	65	.404"	.063" (1,6mm)	46365TL			R4632065-4009TL	H4632065-4009TL
---------------	----	-------	---------------	---------	--	--	-----------------	-----------------

ECHO

MODELS: CS-280, CS-290, CS-300, CS-300EVL, CS-301, CS-302, CS-302S, CS-305, CS-306, CS-310, CS-315, CS-330EVL, CS-330T, CS-340, CS-341, CS-345, CS-346, CS-351, CS-330MX4, CS-352, CS-360, CS-360T, CS-370, CS-370T, CS-400, CS-3000, CS-3400, CS-3450, ECS-2000, ECS3000

12" (30.48cm)	45	3/8"LP NK	.043" (1,1mm)	14345NKTL	M1431245-1041TL			
12" (30.48cm)	45	3/8"LP	.050" (1,3mm)	15045TL	M1501245-1041TL			
14" (35.56cm)	52	3/8"LP NK	.043" (1,1mm)	14352NKTL	M1431452-1041TL			
14" (35.56cm)	52	3/8"LP	.050" (1,3mm)	15052TL	M1501452-1041TL			
16" (40.64cm)	56	3/8"LP NK	.043" (1,1mm)	14356NKTL	M1431656-1041TL			
16" (40.64cm)	56	3/8"LP	.050" (1,3mm)	15056TL	M1501656-1041TL			
16" (40.64cm)	57	3/8"LP	.050" (1,3mm)	15057TL	M1501657-1041TL			
18" (45.72cm)	62	3/8"LP	.050" (1,3mm)	15062TL	M1501862-1041TL			

MODELS: CS-271

10" (25.40cm)	40	3/8"LP	.050" (1,3mm)	15040TL	M1501040-1041TL			
12" (30.48cm)	45	3/8"LP	.050" (1,3mm)	15045TL	M1501245-1041TL			

MODELS: CS-400EVL, CS-440, CS-440EVL, CS-510, CS-520, CS-3600, CS-3900, CS-4000, CS-4100, CS-4400, CS-4500, CS-4600, CS-5000

15" (38.10cm)	64	.325" NK	.050" (1,3mm)	25064NKTL		L2501564-11041TL		
16" (40.64cm)	66	.325" NK	.050" (1,3mm)	25066NKTL		L2501666-11041TL		
16" (40.64cm)	66	.325"	.050" (1,3mm)	25066TL		L2501666-11041TL		
18" (45.72cm)	72	.325" NK	.050" (1,3mm)	25072NKTL		L2501872-11041TL		
18" (45.72cm)	72	.325"	.050" (1,3mm)	25072TL		L2501872-11041TL		
20" (50.80cm)	78	.325"	.050" (1,3mm)	25078TL		L2502078-11041TL		

ECHO continued on page 50



CUTTING LENGTH	DRIVE LINKS	PITCH	GAUGE	CHAIN PART NUMBER	MINI LAMINATE	LAMINATED SPROCKET NOSE	REPLACEABLE SPROCKET NOSE	HARD NOSE
----------------	-------------	-------	-------	-------------------	---------------	-------------------------	---------------------------	-----------

ECHO (cont.)

MODELS: CS-60, CS-60S, CS-451, CS-452, CS-CS-500, CS-501EVL, CS510EVL, CS-550, CS-601, CS-602, CST-610, CS-610T, CS-706, CS-600P, CS-650, CS-660, CS670, CS680, CS-701, CS-702, CS-750, CS-6700, CS-8000

16" (40.64cm)	60	3/8"	.050" (1,3mm)	35060TL		L3501660-4176TL		
18" (45.72cm)	66	3/8"	.050" (1,3mm)	35066TL		L3501866-4176TL		
20" (50.80cm)	70	3/8"	.050" (1,3mm)	35070TL		L3502070-4176TL		

MODELS: CS-900, CS-1001

16" (40.64cm)	60	3/8"	.050" (1,3mm)	35060TL		L3501660-4196TL		
---------------	----	------	---------------	---------	--	-----------------	--	--

MODELS: POLE SAWS: PPT-280, PPF-280, PPT-265, PPT-265H, PPT-265S, PPT-266, PPT-266H, PPT-266S

10" (25.40cm)	40	3/8"LP NK	.043" (1,1mm)	14340TL	M1431040-1041TL			
10" (25.40cm)	40	3/8"LP	.050" (1,3mm)	15040TL	M1501040-1041TL			
12" (30.48cm)	45	3/8"LP NK	.043" (1,1mm)	14345TL	M1431245-1041TL			
12" (30.48cm)	45	3/8"LP	.050" (1,3mm)	15045TL	M1501245-1041TL			
14" (35.56cm)	52	3/8"LP NK	.043" (1,1mm)	14352TL	M1431452-1041TL			
14" (35.56cm)	52	3/8"LP	.050" (1,3mm)	15052TL	M1501452-1041TL			

MODELS: PPF-210, PPF-211, PPF-225, PPT-230, PPT-231, PPT-260, PPT-261, POWER PRUNER: PP300, PP400, PP600, PP800, PP1200, PP1250, PP1260, PP1400, PP1400-D, PPF-2100, PPF-2400, PPT-2400, PPSR-2122, PPSR-2433

10" (25.40cm)	39	3/8"LP NK	.043" (1,1mm)	14339TL	M1431039-1218TL			
10" (25.40cm)	39	3/8"LP	.050" (1,3mm)	15039TL	M1501039-1218TL			
12" (30.48cm)	45	3/8"LP NK	.043" (1,1mm)	14345TL	M1431245-1218TL			

EFCO

MODELS: 132S, MT 3500, MT 3600, MT 3700, MT 3750, MT 4000, MT 4100

12" (30.48cm)	45	3/8"LP	.050" (1,3mm)	15045TL	M1501245-1041TL			
14" (35.56cm)	52	3/8"LP	.050" (1,3mm)	15052TL	M1501452-1041TL			
16" (40.64cm)	56	3/8"LP	.050" (1,3mm)	15056TL	M1501656-1041TL			

MODELS: 147, 152

16" (40.64cm)	66	.325"	.050" (1,3mm)	25066TL		L2501666-11095TL		
16" (40.64cm)	66	.325"	.058" (1,5mm)	25866TL		L2581666-11095TL	R2581666-11095TL	H2581666-11095TL
18" (45.72cm)	72	.325"	.050" (1,3mm)	25072TL		L2501872-11095TL		
18" (45.72cm)	72	.325"	.058" (1,5mm)	25872TL		L2581872-11095TL	R2581872-11095TL	
20" (50.80cm)	78	.325"	.058" (1,5mm)	25878TL			R2582078-11095TL	H2582078-11095TL

MODELS: 156, 165

16" (40.64cm)	59	3/8"	.058" (1,5mm)	35859TL			R3581659-11095TL	H3581659-11095TL
16" (40.64cm)	60	3/8"	.050" (1,3mm)	35060TL		L3501660-11095TL		
16" (40.64cm)	60	3/8"	.058" (1,5mm)	35860TL		L3581660-11095TL		H3581660-11095TL
16" (40.64cm)	66	.325"	.058" (1,5mm)	25866TL		L2581666-11095TL	R2581666-11095TL	H2581666-11095TL
18" (45.72cm)	64	3/8"	.058" (1,5mm)	35864TL		L3581864-11095TL		H3581864-11095TL
18" (45.72cm)	68	3/8"	.058" (1,5mm)	35868TL			R3581868-11095TL	H3581868-11095TL
18" (45.72cm)	72	.325"	.058" (1,5mm)	25872TL		L2581872-11095TL	R2581872-11095TL	
20" (50.80cm)	72	3/8"	.058" (1,5mm)	35872TL			R3582072-11095TL	H3582072-11095TL
20" (50.80cm)	78	.325"	.058" (1,5mm)	35878TL			R2582078-11095TL	H2582078-11095TL

EFCO continued on page 51

NOTE: Low kickback requirements in the ANSI standard apply to saw models less than 3.8 cubic inches (62cc). Low kickback performance requirements in the ANSI standard do not apply to saws larger than 3.8 cubic inches.



CUTTING LENGTH	DRIVE LINKS	PITCH	GAUGE	CHAIN PART NUMBER	MINI LAMINATE	LAMINATED SPROCKET NOSE	REPLACEABLE SPROCKET NOSE	HARD NOSE
----------------	-------------	-------	-------	-------------------	---------------	-------------------------	---------------------------	-----------

EFCO (cont.)

MODELS: 181, MT 7200, MT 8200

20" (50.80cm)	72	3/8"	.050" (1,3mm)	35072TL		L3502072-4009TL		
20" (50.80cm)	72	3/8"	.058" (1,5mm)	35872TL		L3582072-4009TL	R3582072-4009TL	H3582072-4009TL
24" (60.96cm)	84	3/8"	.058" (1,5mm)	35884TL			R3582484-4009TL	H3582484-4009TL

FAIRMONT

MODELS: 38568, 43177, 43178, HCS513, HCS516, HCS520, HPS513, LIMBLOPPER

13" (33.02cm)	56	.325" NK	.050" (1,3mm)	25056NKTL		L2501356-11095TL		
15" (38.10cm)	64	.325" NK	.050" (1,3mm)	25064NKTL		L2501564-11095TL		
15" (38.10cm)	64	.325"	.058" (1,5mm)	25864TL			R2581564-11095TL	H2581564-11095TL
16" (40.64cm)	66	.325" NK	.050" (1,3mm)	25066NKTL		L2501666-11095TL		
16" (40.64cm)	66	.325"	.058" (1,5mm)	25866TL			R2581666-11095TL	H2581666-11095TL
18" (45.72cm)	72	.325" NK	.050" (1,3mm)	25072NKTL		L2501872-11095TL		
18" (45.72cm)	72	.325"	.058" (1,5mm)	25872TL			R2581872-11095TL	
20" (50.80cm)	78	.325"	.058" (1,5mm)	25878TL			R2582078-11095TL	H2582078-11095TL

MODELS: HCS816, HCS820, HCS824

16" (40.64cm)	60	3/8"	.050" (1,3mm)	35060TL		L3501660-11095TL		
16" (40.64cm)	60	3/8"	.058" (1,5mm)	35860TL		L3581660-10095TL		H3581660-11095TL
18" (45.72cm)	68	3/8"	.058" (1,5mm)	35868TL			R3581868-11095TL	H3581868-11095TL
20" (50.80cm)	72	3/8"	.058" (1,5mm)	35872TL			R3582072-11095TL	H3582072-11095TL

MODELS: H6200B

16" (40.64cm)	60	3/8"	.050" (1,3mm)	35060TL		L3501660-4176TL		
---------------	----	------	---------------	---------	--	-----------------	--	--

HOMELITE

MODELS: POWER PRUNERS: UT15520A, EXPAND-IT

10" (25.40cm)	40	3/8" LP NK	.043" (1,1mm)	14340TL	M1431040-1041TL			
---------------	----	------------	---------------	---------	-----------------	--	--	--

MODELS: 25, 27, 4100, 4500, 4550, d4550b, i3850b, i4150b, i4550b, Super 240, Timberman, UT10518, UT10520, ZR10522, UT10526, UT10550, UT10552, UT10896, UT10910, UT10927A, UT10942A, UT10946A

16" (40.64cm)	66	.325"	.050" (1,3mm)	25066TL		L2501666-11041TL		
18" (45.72cm)	72	.325"	.050" (1,3mm)	25072TL		L2501872-11041TL		
20" (50.80cm)	78	.325"	.050" (1,3mm)	25078TL		L2502078-11041TL		

MODELS: CS-40, CS-50, 290

16" (40.64cm)	66	.325"	.050" (1,3mm)	25066TL		L2501666-11095TL		
18" (45.72cm)	72	.325"	.050" (1,3mm)	25072TL		L2501872-11095TL		

MODELS: 20, 20AV, 23, 23AV, 27, 3300, 3314, 3316, 3318, 3350, 3800, 3850, 4500, 4550, CS-40, D3300, D3350B, D3850, I3350B, PS33, RANGER, UT10516, UT10517, UT10530, UT10530A, UT10540, ZR10540, UT10548, UT10560, ZR10560, UT10568, UT10564, UT10566, UT10580, ZR10580, UT10584, UT10586, UT10588, UT10901, UT10901A, UT10926, UT10947A, UT10947D, UT10947E, UT43100, UT43102, UT43103, UT43120, UT43122, Z3850

12" (30.48cm)	45	3/8" LP	.050" (1,3mm)	15045TL	M1501245-1041TL			
14" (35.56cm)	52	3/8" LP	.050" (1,3mm)	15052TL	M1501452-1041TL			
16" (40.64cm)	56	3/8" LP	.050" (1,3mm)	15056TL	M1501656-1041TL			
18" (45.72cm)	62	3/8" LP	.050" (1,3mm)	15062TL	M1501862-1041TL			

MODELS: 180 Series, 190, 192, BANDIT, CLASSIC 192, ELECTRIC 200, 240, 240SL, 245, LITTLE RED, LX-30, SUPER 2, SUPER 2CC, VI SUPER 2, XEL-14, XEL ELECTRIC, XL, XL2, XL-2CC, XL-10, XL-14, XL-16

12" (30.48cm)	48	3/8" LP	.050" (1,3mm)	15048TL	M1501248-1061TL			
14" (35.56cm)	53	3/8" LP	.050" (1,3mm)	15053TL	M1501453-1061TL			
16" (40.64cm)	59	3/8" LP	.050" (1,3mm)	15059TL	M1501659-1061TL			

HOMELITE continued on page 52



CUTTING LENGTH	DRIVE LINKS	PITCH	GAUGE	CHAIN PART NUMBER	MINI LAMINATE	LAMINATED SPROCKET NOSE	REPLACEABLE SPROCKET NOSE	HARD NOSE
----------------	-------------	-------	-------	-------------------	---------------	-------------------------	---------------------------	-----------

HOMELITE (cont.)

MODELS: 30, 130, 150, 150AO, 250, 290, 300, 340, BIG RED, EZ250, MINI SL, SUPER EZ AO, XL-76, XL 100 Series

16" (40.64cm)	59	3/8"	.050" (1,3mm)	35059TL		L3501659-11095TL		
---------------	----	------	---------------	---------	--	------------------	--	--

MODELS: 33SL, 330, 350, 350HG, 350SL, 360, SUPER XL, SUPER XL-AO, XL-12, XL-15, 400, 410, 450, 460, 540, 550, 650, 700, 75, 800, 850, 900, 922, 933, SUPER XL 925, V-955, XL 400, XL 700 Series, XL 800 Series, XL 900 Series

16" (40.64cm)	59	3/8"	.050" (1,3mm)	35059TL		L3501659-4196TL		
16" (40.64cm)	60	3/8"	.050" (1,3mm)	35060TL		L3501660-4196TL		

HUSQVARNA

MODELS: 334T, 335, 335XPT, 338XPT, 1400, 1600, 316 ELECTRIC, T435

12" (30.48cm)	45	3/8"LP	.050" (1,3mm)	15045TL	M1501245-1095TL			
14" (35.56cm)	52	3/8"LP NK	.043" (1,1mm)	14352TL	M1431452-1095TL			
14" (35.56cm)	52	3/8"LP	.050" (1,3mm)	15052TL	M1501452-1095TL			
16" (40.64cm)	56	3/8"LP	.050" (1,3mm)	15056TL	M1501656-1095TL			

MODELS: POLE PRUNERS: 325P5X, 326P4, P27P4, 327P5X

12" (30.48cm)	45	3/8"LP	.050" (1,3mm)	15045TL	M1501245-1095TL			
---------------	----	--------	---------------	---------	-----------------	--	--	--

MODELS: 33, 44, 45, 49, 50, 51, 55, 55 RANCHER, 57, 133, 154, 234, 238, 242, 246, 254, 257, 261, 262, 336, 340, 345, 346, 350, 351, 353, 242XP, 254XP, 262XP, 339XP, 346XP, 346XP E-TECH, 346XPG, 353 E-TECH, 353G E-TECH, 357XP, 359, 359 E-TECH, 360, 435, 435E, 440E, 444, 445, 445E, 450, 450E, 455, 455E RANCHER, 455 RANCHER, 460, 460 RANCHER, 466, 545, 550XP, 550XPG

13" (33.02cm)	56	.325" NK	.050" (1,3mm)	25056NKTL		L2501356-11095TL		
15" (38.10cm)	64	.325" NK	.050" (1,3mm)	25064NKTL		L2501564-11095TL		
15" (38.10cm)	64	.325"	.058" (1,5mm)	25864TL		L2581564-11095TL	R2581564-11095TL	
16" (40.64cm)	59	3/8"	.050" (1,3mm)	35059TL		L3501659-11095TL		
16" (40.64cm)	60	3/8"	.050" (1,3mm)	35060TL		L3501660-11095TL		
16" (40.64cm)	66	.325" NK	.050" (1,3mm)	25066NKTL		L2501666-11095TL		
16" (40.64cm)	66	.325"	.050" (1,3mm)	25066TL		L2501666-11095TL		
16" (40.64cm)	66	.325"	.058" (1,5mm)	25866TL		L2581666-11095TL	R2581666-11095TL	
18" (45.72cm)	72	.325" NK	.050" (1,3mm)	25072NKTL		L2501872-11095TL		
18" (45.72cm)	72	.325"	.050" (1,3mm)	25072TL		L2501872-11095TL		
18" (45.72cm)	72	.325"	.058" (1,5mm)	25872TL		L2581872-11095TL	R2581872-11095TL	
20" (50.80cm)	78	.325"	.058" (1,5mm)	25878TL		L2582078-11095TL	R2582078-11095TL	

MODELS: 23, 36, 41, 136, 137, 141, 142, 235, 235E, 240, 240E, 243, 249

12" (30.48cm)	45	3/8"LP NK	.043" (1,1mm)	14345TL	M1431245-1041TL			
12" (30.48cm)	45	3/8"LP	.050" (1,3mm)	15045TL	M1501245-1041TL			
14" (35.56cm)	52	3/8"LP NK	.043" (1,1mm)	14352TL	M1431452-1041TL			
14" (35.56cm)	52	3/8"LP	.050" (1,3mm)	15052TL	M1501452-1041TL			
16" (40.64cm)	56	3/8"LP NK	.043" (1,1mm)	14356TL	M1431656-1041TL			
16" (40.64cm)	56	3/8"LP	.050" (1,3mm)	15056TL	M1501656-1041TL			
16" (40.64cm)	66	.325"	.050" (1,3mm)	25066TL		L2501666-11041TL		
18" (45.72cm)	62	3/8"LP	.050" (1,3mm)	15062TL	M1501862-1041TL			
18" (45.72cm)	72	.325"	.050" (1,3mm)	25072TL		L2501872-11041TL		
20" (50.80cm)	78	.325"	.050" (1,3mm)	25078TL		L2502078-11041TL		

HUSQVARNA continued on page 53

NOTE: Low kickback requirements in the ANSI standard apply to saw models less than 3.8 cubic inches (62cc). Low kickback performance requirements in the ANSI standard do not apply to saws larger than 3.8 cubic inches.



CUTTING LENGTH	DRIVE LINKS	PITCH	GAUGE	CHAIN PART NUMBER	MINI LAMINATE	LAMINATED SPROCKET NOSE	REPLACEABLE SPROCKET NOSE	HARD NOSE
----------------	-------------	-------	-------	-------------------	---------------	-------------------------	---------------------------	-----------

HUSQVARNA (cont.)

MODELS: 61, 160, 162, 260

13" (33.02cm)	52	3/8"	.058" (1,5mm)	35852TL			R3581352-4009TL	H3581352-4009TL
15" (38.10cm)	56	3/8"	.058" (1,5mm)	35856TL		L3581556-4009TL	R3581556-4009TL	H3581556-4009TL
16" (40.64cm)	60	3/8"	.050" (1,3mm)	35060TL		L3501660-4009TL		
16" (40.64cm)	60	3/8"	.058" (1,5mm)	35860TL		L3581660-4009TL	R3581660-4009TL	H3581660-4009TL
18" (45.72cm)	68	3/8"	.050" (1,3mm)	35068TL		L3501868-4009TL		
18" (45.72cm)	68	3/8"	.058" (1,5mm)	35868TL		L3581868-4009TL	R3581868-4009TL	H3581868-4009TL
20" (50.80cm)	72	3/8"	.050" (1,3mm)	35072TL		L3502072-4009TL		
20" (50.80cm)	72	3/8"	.058" (1,5mm)	35872TL		L3582072-4009TL	R3582072-4009TL	H3582072-4009TL
20" (50.80cm)	72	3/8"	.063" (1,6mm)	36372TL		L3632072-4009TL	R3632072-4009TL	H3632072-4009TL
24" (60.96cm)	84	3/8"	.058" (1,5mm)	35884TL			R3582484-4009TL	H3582484-4009TL
24" (60.96cm)	84	3/8"	.063" (1,6mm)	36384TL			R3632484-4009TL	H3632484-4009TL
28" (71.12cm)	92	3/8"	.058" (1,5mm)	35892TL			R3582892-4009TL	H3582892-4009TL

MODELS: 362, 362XP

13" (33.02cm)	56	.325" NK	.050" (1,3mm)	25056NKTL		L2501356-11095TL		
15" (38.10cm)	64	.325" NK	.050" (1,3mm)	25064NKTL		L2501564-11095TL		
15" (38.10cm)	64	.325"	.058" (1,5mm)	25864TL		L2581564-11095TL		H2581564-11095TL
16" (40.64cm)	59	3/8"	.050" (1,3mm)	35059TL		L3501659-11095TL		
16" (40.64cm)	59	3/8"	.058" (1,5mm)	35859TL		L3581659-11095TL	R3581659-11095TL	H3581659-11095TL
16" (40.64cm)	60	3/8"	.050" (1,3mm)	35060TL		L3501660-11095TL		
16" (40.64cm)	60	3/8"	.058" (1,5mm)	35860TL		L3581660-11095TL		H3581660-11095TL
16" (40.64cm)	66	.325" NK	.050" (1,3mm)	25066NKTL		L2501666-11095TL		
16" (40.64cm)	66	.325"	.050" (1,3mm)	25066TL		L2501666-11095TL		
16" (40.64cm)	66	.325"	.058" (1,5mm)	25866TL		L2581666-11095TL	R2581666-11095TL	H2581666-11095TL
18" (45.72cm)	64	3/8"	.058" (1,5mm)	35864TL		L3581864-11095TL		H3581864-11095TL
18" (45.72cm)	68	3/8"	.058" (1,5mm)	35868TL			R3581868-11095TL	H3581868-11095TL
18" (45.72cm)	72	.325" NK	.050" (1,3mm)	25072NKTL		L2501872-11095TL		
18" (45.72cm)	72	.325"	.050" (1,3mm)	25072TL		L2501872-11095TL		
18" (45.72cm)	72	.325"	.058" (1,5mm)	25872TL		L2581872-11095TL	R2581872-11095TL	
20" (50.80cm)	72	3/8"	.058" (1,5mm)	35872TL			R3582072-11095TL	H3582072-11095TL
20" (50.80cm)	76	3/8"	.058" (1,5mm)	35876TL				H3582076-11095TL
22" (55.88cm)	78	.325"	.058" (1,5mm)	25878TL			R2582278-11095TL	H2582278-11095TL

MODELS: L Series, 65, 66, 70, 77, 181, 185, 266, 268, 272, 281, 285, 288XP LITE, 298, 365, 371, 372, 372XP, 372XPW, 380, 385, 385XPG, 385XPW, 390XP, 390XPG, 390XPW, 394, 394XP, 395, 395XP, 395XPG, 395XPW, 480, 562XP, 562XPG, 570, 575XP, 575XPG, 575XPW, 576XP, 576XP AUTO TUNE, 576XPG, 576XPW, 1100, 2100, 2101, 3120, 3120XP, JUNGLE 3120

13" (33.02cm)	52	3/8"	.058" (1,5mm)	35852TL			R3581352-4009TL	H3581352-4009TL
15" (38.10cm)	56	3/8"	.058" (1,5mm)	35856TL		L3581556-4009TL	R3581556-4009TL	H3581556-4009TL
16" (40.64cm)	60	3/8"	.050" (1,3mm)	35060TL		L3501660-4009TL		
16" (40.64cm)	60	3/8"	.058" (1,5mm)	35860TL		L3581660-4009TL	R3581660-4009TL	H3581660-4009TL
18" (45.72cm)	68	3/8"	.050" (1,3mm)	35068TL		L3501868-4009TL		
18" (45.72cm)	68	3/8"	.058" (1,5mm)	35868TL		L3581868-4009TL	R3581868-4009TL	H3581868-4009TL
20" (50.80cm)	72	3/8"	.050" (1,3mm)	35072TL		L3502072-4009TL		
20" (50.80cm)	72	3/8"	.058" (1,5mm)	35872TL		L3582072-4009TL	R3582072-4009TL	H3582072-4009TL
20" (50.80cm)	72	3/8"	.063" (1,6mm)	36372TL		L3632072-4009TL	R3632072-4009TL	H3632072-4009TL
24" (60.96cm)	84	3/8"	.058" (1,5mm)	35884TL			R3582484-4009TL	H3582484-4009TL
24" (60.96cm)	84	3/8"	.063" (1,6mm)	36384TL			R3632484-4009TL	H3632484-4009TL
28" (71.12cm)	92	3/8"	.058" (1,5mm)	35892TL			R3582892-4009TL	H3582892-4009TL
28" (71.12cm)	92	3/8"	.063" (1,6mm)	36392TL			R3632892-4009TL	H3632892-4009TL
28" (71.12cm)	93	3/8"	.063" (1,6mm)	36393TL				H3632893-4009TL
36" (91.44cm)	115	3/8"	.058" (1,5mm)	358115TL			R35836115-4009TL	H35836115-4009TL
36" (91.44cm)	115	3/8"	.063" (1,6mm)	363115TL			R36336115-4009TL	H36336115-4009TL



CUTTING LENGTH	DRIVE LINKS	PITCH	GAUGE	CHAIN PART NUMBER	MINI LAMINATE	LAMINATED SPROCKET NOSE	REPLACEABLE SPROCKET NOSE	HARD NOSE
----------------	-------------	-------	-------	-------------------	---------------	-------------------------	---------------------------	-----------

JOHN DEERE

MODELS: Quic-tatch Pruner PS2383, PS2683, PSA10

10" (25.40cm)	40	3/8"LP	.043" (1,1mm)	14340TL	M1431040-1041TL			
---------------	----	--------	---------------	---------	-----------------	--	--	--

MODELS: 25EV, 28, 28V, 30, 30V, 35, 35EV, 40V, 200CS, 230CS, CS36, CS36LE, CS40, CS40V, J3816

10" (25.40cm)	40	3/8"LP NK	.043" (1,1mm)	14340TL	M1431040-1041TL			
10" (25.40cm)	40	3/8"LP	.050" (1,3mm)	15040TL	M1501040-1041TL			
12" (30.48cm)	45	3/8"LP NK	.043" (1,1mm)	14345TL	M1431245-1041TL			
12" (30.48cm)	45	3/8"LP	.050" (1,3mm)	15045TL	M1501245-1041TL			
14" (35.56cm)	52	3/8"LP NK	.043" (1,1mm)	14352TL	M1431452-1041TL			
14" (35.56cm)	52	3/8"LP	.050" (1,3mm)	15052TL	M1501452-1041TL			
16" (40.64cm)	56	3/8"LP NK	.043" (1,1mm)	14356TL	M1431656-1041TL			
16" (40.64cm)	56	3/8"LP	.050" (1,3mm)	15056TL	M1501656-1041TL			
18" (45.72cm)	62	3/8"LP	.050" (1,3mm)	15062TL	M1501862-1041TL			

MODELS: 45EV, 76EV, 450V, 300CS, 350CS, 46EV

16" (40.64cm)	66	.325"	.050" (1,3mm)	25066TL		L2501666-11041TL		
18" (45.72cm)	72	.325"	.050" (1,3mm)	25072TL		L2501872-11041TL		
20" (50.80cm)	78	.325"	.050" (1,3mm)	25078TL		L2502078-11041TL		

MODELS: CS-46, CS-52, CS-56, CS-62

16" (40.64cm)	66	.325" NK	.050" (1,3mm)	25066NKTL		L2501666-11095TL		
16" (40.64cm)	66	.325"	.050" (1,3mm)	25066TL		L2501666-11095TL		
18" (45.72cm)	72	.325" NK	.050" (1,3mm)	25072NKTL		L2501872-11095TL		
18" (45.72cm)	72	.325"	.050" (1,3mm)	25072TL		L2501872-11095TL		

MODELS: 50AV, 50V, 51SV, 55EV, 55V, 55SV, 550CS, 60V, 65, 65EV, 65SV, 66SV, 80EV, 800V

16" (40.64cm)	60	3/8"	.050" (1,3mm)	35060TL		L3501660-4176TL		
18" (45.72cm)	66	3/8"	.050" (1,3mm)	35066TL		L3501866-4176TL		
20" (50.80cm)	70	3/8"	.050" (1,3mm)	35070TL		L3502070-4176TL		

MODELS: CS62

16" (40.64cm)	59	3/8"	.050" (1,3mm)	35059TL		L3501659-11095TL		
16" (40.64cm)	60	3/8"	.050" (1,3mm)	35060TL		L3501660-11095TL		
18" (45.72cm)	64	3/8"	.050" (1,3mm)	35064TL		L3501864-11095TL		

JONSERED

MODELS: 2014, 2016, 2035, 2036, 2036 TURBO, 2041, 2045, 2137, 2138, CS2135, CS2137, CS2138, CS2152W, CS2283S

12" (30.48cm)	45	3/8"LP NK	.043" (1,1mm)	14345TL	M1431245-1041TL			
12" (30.48cm)	45	3/8"LP	.050" (1,3mm)	15045TL	M1501245-1041TL			
14" (35.56cm)	52	3/8"LP NK	.043" (1,1mm)	14352TL	M1431452-1041TL			
14" (35.56cm)	52	3/8"LP	.050" (1,3mm)	15052TL	M1501452-1041TL			
16" (40.64cm)	56	3/8"LP NK	.043" (1,1mm)	14356TL	M1431656-1041TL			
16" (40.64cm)	56	3/8"LP	.050" (1,3mm)	15056TL	M1501656-1041TL			

MODELS: 2050, 2050 TURBO, 2051, 2054, 2149, 2149 TURBO, 370, 410, 450, 425, 435, 45, 450, 451, 455, 49, 50, 51, 510, 52, 521, 525, 535, CS2145, CS2149 TURBO, CS2150, CS2152W, CS2153, CS2156, CS2159, CS2159C, CS2159WH, CS2163, CS2245, CS2250, CS2250S, CS2255

13" (33.02cm)	56	.325" NK	.050" (1,3mm)	25056NKTL		L2501356-11095TL		
15" (38.10cm)	64	.325" NK	.050" (1,3mm)	25064NKTL		L2501564-11095TL		
15" (38.10cm)	64	.325"	.058" (1,5mm)	25864TL		L2581564-11095TL	R2581564-11095TL	H2581564-11095TL
16" (40.64cm)	66	.325" NK	.050" (1,3mm)	25066NKTL		L2501666-11095TL		
16" (40.64cm)	66	.325"	.050" (1,3mm)	25066TL		L2501666-11095TL		
16" (40.64cm)	66	.325"	.058" (1,5mm)	25866TL		L2581666-11095TL	R2581666-11095TL	H2581666-11095TL
18" (45.72cm)	72	.325" NK	.050" (1,3mm)	25072NKTL		L2501872-11095TL		
18" (45.72cm)	72	.325"	.050" (1,3mm)	25072TL		L2501872-11095TL		
18" (45.72cm)	72	.325"	.058" (1,5mm)	25872TL		L2581872-11095TL	R2581872-11095TL	
20" (50.80cm)	78	.325"	.058" (1,5mm)	25878TL		L2582078-11095TL	R2582078-11095TL	H2582078-11095TL

JONSERED continued on page 55

NOTE: Low kickback requirements in the ANSI standard apply to saw models less than 3.8 cubic inches (62cc). Low kickback performance requirements in the ANSI standard do not apply to saws larger than 3.8 cubic inches.



CUTTING LENGTH	DRIVE LINKS	PITCH	GAUGE	CHAIN PART NUMBER	MINI LAMINATE	LAMINATED SPROCKET NOSE	REPLACEABLE SPROCKET NOSE	HARD NOSE
----------------	-------------	-------	-------	-------------------	---------------	-------------------------	---------------------------	-----------

JONSERED (cont.)

MODELS: 2014, 2016, 2036, 20036 TURBO, 2040, 2040 TURBO, 2041, 2045, 2141, CS-2141

15" (38.10cm)	64	.325" NK	.050" (1,3mm)	25064NKTL		L2501564-11041TL		
16" (40.64cm)	66	.325" NK	.050" (1,3mm)	25066NKTL		L2501666-11041TL		
16" (40.64cm)	66	.325"	.050" (1,3mm)	25066TL		L2501666-11041TL		
16" (40.64cm)	66	.325"	.058" (1,5mm)	25866TL		L2581666-11041TL		
18" (45.72cm)	72	.325"	.058" (1,5mm)	25872TL			R2581872-11041TL	H2581872-11041TL
20" (50.80cm)	78	.325"	.050" (1,3mm)	25078TL		L2502078-11041TL		

MODELS: 490, 520SP, 525, 535, 590, 2050, 2055, 2063, CS-2149, CS-2050, CS-2050 TURBO, CS-2054, CS-2156, CS-2159, CS-2159C, CS-2159CWH, CS-2156WH, 2163, CS-2163, CS-2163WH, CS-2255

16" (40.64cm)	59	3/8"	.058" (1,5mm)	35859TL		L3581659-11095TL	R3581659-11095TL	H3581659-11095TL
16" (40.64cm)	60	3/8"	.050" (1,3mm)	35060TL		L3501660-11095TL		
16" (40.64cm)	60	3/8"	.058" (1,5mm)	35860TL		L3581660-11095TL		H3581660-11095TL
18" (45.72cm)	64	3/8"	.050" (1,3mm)	35064TL		L3501864-11095TL		
18" (45.72cm)	64	3/8"	.058" (1,5mm)	35864TL		L3581864-11095TL		H3581864-11095TL
18" (45.72cm)	68	3/8"	.058" (1,5mm)	35868TL			R3581868-11095TL	H3581868-11095TL
20" (50.80cm)	72	3/8"	.058" (1,5mm)	35872TL			R3582072-11095TL	H3582072-11095TL
22" (55.88cm)	76	3/8"	.058" (1,5mm)	35876TL				H3582276-11095TL

MODELS: 625, 630, 630 SUPER, 630 WEST COAST, 2065, 2071, 2165, 2171, CS-2165, CS-2171, CS-217WH, CS-2186, CS2186WH, CS-2188

13" (33.02cm)	52	3/8"	.058" (1,5mm)	35852TL			R3581352-4009TL	H3581352-4009TL
15" (38.10cm)	56	3/8"	.058" (1,5mm)	35856TL		L3581556-4009TL	R3581556-4009TL	H3581556-4009TL
16" (40.64cm)	60	3/8"	.050" (1,3mm)	35060TL		L3501660-4009TL		
16" (40.64cm)	60	3/8"	.058" (1,5mm)	35860TL		L3581660-4009TL	R3581660-4009TL	H3581660-4009TL
18" (45.72cm)	68	3/8"	.050" (1,3mm)	35068TL		L3501868-4009TL		
18" (45.72cm)	68	3/8"	.058" (1,5mm)	35868TL		L3581868-4009TL	R3581868-4009TL	H3581868-4009TL
20" (50.80cm)	72	3/8"	.050" (1,3mm)	35072TL		L3502072-4009TL		
20" (50.80cm)	72	3/8"	.058" (1,5mm)	35872TL		L3582072-4009TL	R3582072-4009TL	H3582072-4009TL
24" (60.96cm)	84	3/8"	.058" (1,5mm)	35884TL			R3582484-4009TL	H3582484-4009TL
28" (71.12cm)	92	3/8"	.058" (1,5mm)	35892TL			R3582892-4009TL	H3582892-4009TL
36" (91.44cm)	115	3/8"	.058" (1,5mm)	358115TL			R35836115-4009TL	H35836115-4009TL

MODELS: 60, 61, 62, 621, 2350

16" (40.64cm)	60	3/8"	.058" (1,5mm)	35860TL		L3501659-4196TL	R3581659-4196TL	
20" (50.80cm)	72	3/8"	.058" (1,5mm)	35872TL			R3582070-4196TL	
24" (60.96cm)	81	3/8"	.058" (1,5mm)	35881TL			R3582481-4196TL	

MODELS: 670, 670 WEST COAST, 2083, 2083II, 2094, 2095

13" (33.02cm)	52	3/8"	.058" (1,5mm)	35852TL			R3581352-4009TL	
15" (38.10cm)	56	3/8"	.058" (1,5mm)	35856TL		L3581556-4009TL	R3581556-4009TL	H3581556-4009TL
16" (40.64cm)	60	3/8"	.050" (1,3mm)	35060TL		L3501660-4009TL		
16" (40.64cm)	60	3/8"	.058" (1,5mm)	35860TL		L3581660-4009TL	R3581660-4009TL	H3581660-4009TL
18" (45.72cm)	68	3/8"	.050" (1,3mm)	35068TL		L3501868-4009TL		
18" (45.72cm)	68	3/8"	.058" (1,5mm)	35868TL		L3581868-4009TL	R3581868-4009TL	H3581868-4009TL
20" (50.80cm)	72	3/8"	.050" (1,3mm)	35072TL		L3502072-4009TL		
20" (50.80cm)	72	3/8"	.058" (1,5mm)	35872TL		L3582072-4009TL	R3582072-4009TL	H3582072-4009TL
20" (50.80cm)	72	3/8"	.063" (1,6mm)	36372TL		L3632072-4009TL	R3632072-4009TL	H3632072-4009TL
24" (60.96cm)	84	3/8"	.058" (1,5mm)	35884TL			R3582484-4009TL	H3582484-4009TL
24" (60.96cm)	84	3/8"	.063" (1,6mm)	36384TL			R3632484-4009TL	H3632484-4009TL
28" (71.12cm)	92	3/8"	.058" (1,5mm)	35892TL			R3582892-4009TL	H3582892-4009TL
28" (71.12cm)	92	3/8"	.063" (1,6mm)	36392TL			R3632892-4009TL	H3632892-4009TL
28" (71.12cm)	93	3/8"	.058" (1,5mm)	35893TL				H3582893-4009TL
28" (71.12cm)	93	3/8"	.063" (1,6mm)	36393TL				H3632893-4009TL
36" (91.44cm)	115	3/8"	.058" (1,5mm)	358115TL			R35836115-4009TL	H35836115-4009TL
36" (91.44cm)	115	3/8"	.063" (1,6mm)	363115TL			R36336115-4009TL	H36336115-4009TL

MODELS: 670, 670 WEST COAST, 2077, 2083, 2094, 2095

20" (50.80cm)	65	.404"	.063" (1,6mm)	46365TL				H4632065-4009TL
---------------	----	-------	---------------	---------	--	--	--	-----------------



CUTTING LENGTH	DRIVE LINKS	PITCH	GAUGE	CHAIN PART NUMBER	MINI LAMINATE	LAMINATED SPROCKET NOSE	REPLACEABLE SPROCKET NOSE	HARD NOSE
----------------	-------------	-------	-------	-------------------	---------------	-------------------------	---------------------------	-----------

MAKITA

MODELS: 5012B, 5014NB, 5016NB, DCS 330S, DCS 330TH, DCS 34, DCS340, DCS 341, DCS 390, DCS 390S, DCS 400, DCS 401, DCS 3416, UC3030A, UC3500, UC40000, UC4030A

12" (30.48cm)	45	3/8" LP NK	.043" (1,1mm)	14345TL	M1431245-1041TL			
12" (30.48cm)	45	3/8" LP	.050" (1,3mm)	15045TL	M1501245-1041TL	L1501245-1041TL		
14" (35.56cm)	52	3/8" LP NK	.043" (1,1mm)	14352TL	M1431452-1041TL			
14" (35.56cm)	52	3/8" LP	.050" (1,3mm)	15052TL	M1501452-1041TL	L1501452-1041TL		
16" (40.64cm)	56	3/8" LP NK	.043" (1,1mm)	14356TL	M1431656-1041TL			
16" (40.64cm)	56	3/8" LP	.050" (1,3mm)	15056TL	M1501656-1041TL	L1501656-1041TL		
18" (45.72cm)	62	3/8" LP	.050" (1,3mm)	15062TL	M1501862-1041TL	L1501862-1041TL		

MODELS: DCS 460, DCS 510, DCS 430, DCS 431, DCS 5121, DCS 520i, DCS 540, DCS 5200i

13" (33.02cm)	56	.325" NK	.050" (1,3mm)	25056NKTL		L2501356-11095TL		
15" (38.10cm)	64	.325" NK	.050" (1,3mm)	25064NKTL		L2501564-11095TL		
15" (38.10cm)	64	.325"	.058" (1,5mm)	25864TL		L2581564-11095TL	R2581564-11095TL	H2581564-11095TL
16" (40.64cm)	66	.325" NK	.050" (1,3mm)	25066NKTL		L2501666-11095TL		
16" (40.64cm)	66	.325"	.050" (1,3mm)	25066TL		L2501666-11095TL		
16" (40.64cm)	66	.325"	.058" (1,5mm)	25866TL		L2581666-11095TL	R2581666-11095TL	H2581666-11095TL
18" (45.72cm)	72	.325" NK	.050" (1,3mm)	25072NKTL		L2501872-11095TL		
18" (45.72cm)	72	.325"	.050" (1,3mm)	25072TL		L2501872-11095TL		
18" (45.72cm)	72	.325"	.058" (1,5mm)	25872TL		L2581872-11095TL	R2581872-11095TL	
20" (50.80cm)	78	.325"	.058" (1,5mm)	25878TL		L2582078-11095TL	R2582078-11095TL	H2582078-11095TL

MODELS: DCS 460, DCS 510, DCS 5121, DCS 520i, DCS 540, DCS 5200i, DCS 6000i

16" (40.64cm)	59	3/8"	.050" (1,3mm)	35059TL		L3501659-11095TL		
16" (40.64cm)	59	3/8"	.058" (1,5mm)	35859TL				H3581659-11095TL
16" (40.64cm)	60	3/8"	.050" (1,3mm)	35060TL		L3501660-11095TL		
16" (40.64cm)	60	3/8"	.058" (1,5mm)	35860TL		L3581660-11095TL		H3581660-11095TL
18" (45.72cm)	64	3/8"	.058" (1,5mm)	35864TL		L3581864-11095TL		H3581864-11095TL

MODELS: DCS 6800i

16" (40.64cm)	59	3/8"	.050" (1,3mm)	35059TL		L3501659-11095TL		
16" (40.64cm)	59	3/8"	.058" (1,5mm)	35859TL		L3581659-11095TL		H3581659-11095TL
16" (40.64cm)	60	3/8"	.050" (1,3mm)	35060TL		L3501660-11095TL		
16" (40.64cm)	60	3/8"	.058" (1,5mm)	35860TL		L3581660-11095TL		H3581660-11095TL
18" (45.72cm)	64	3/8"	.050" (1,3mm)	35064TL		L3501864-11095TL		
18" (45.72cm)	64	3/8"	.058" (1,5mm)	35864TL		L3581864-11095TL		H3581864-11095TL

MODELS: DCS 6401, DCS6421, DCS 7301, DCS 7901, DCS 9000, DCS 9010FL

13" (33.02cm)	52	3/8"	.058" (1,5mm)	35852TL			R3581352-4009TL	H3581352-4009TL
15" (38.10cm)	56	3/8"	.058" (1,5mm)	35856TL		L3581556-4009TL	R3581556-4009TL	H3581556-4009TL
16" (40.64cm)	60	3/8"	.050" (1,3mm)	35060TL		L3501660-4009TL		
16" (40.64cm)	60	3/8"	.058" (1,5mm)	35860TL		L3581660-4009TL	R3581660-4009TL	H3581660-4009TL
18" (45.72cm)	68	3/8"	.050" (1,3mm)	35068TL		L3501868-4009TL		
18" (45.72cm)	68	3/8"	.058" (1,5mm)	35868TL		L3581868-4009TL	R3581868-4009TL	H3581868-4009TL
20" (50.80cm)	72	3/8"	.050" (1,3mm)	35072TL		L3502072-4009TL		
20" (50.80cm)	72	3/8"	.058" (1,5mm)	35872TL		L3582072-4009TL	R3582072-4009TL	H3582072-4009TL
20" (50.80cm)	72	3/8"	.063" (1,6mm)	36372TL		L3632072-4009TL	R3632072-4009TL	H3632072-4009TL
24" (60.96cm)	84	3/8"	.058" (1,5mm)	35884TL			R3582484-4009TL	H3582484-4009TL
24" (60.96cm)	84	3/8"	.063" (1,6mm)	36384TL			R3632484-4009TL	H3632484-4009TL
28" (71.12cm)	92	3/8"	.058" (1,5mm)	35892TL			R3582892-4009TL	H3582892-4009TL
28" (71.12cm)	92	3/8"	.063" (1,6mm)	36392TL			R3632892-4009TL	H3632892-4009TL
28" (71.12cm)	93	3/8"	.063" (1,6mm)	36393TL				H3632893-4009TL
36" (91.44cm)	115	3/8"	.058" (1,5mm)	358115TL			R35836115-4009TL	
36" (91.44cm)	115	3/8"	.063" (1,6mm)	363115TL				H36336115-4009TL

MODELS: DCS 9000, DCS 9010FL

20" (50.80cm)	65	.404"	.063" (1,6mm)	46365TL				H4632065-4009TL
---------------	----	-------	---------------	---------	--	--	--	-----------------

NOTE: Low kickback requirements in the ANSI standard apply to saw models less than 3.8 cubic inches (62cc). Low kickback performance requirements in the ANSI standard do not apply to saws larger than 3.8 cubic inches.



CUTTING LENGTH	DRIVE LINKS	PITCH	GAUGE	CHAIN PART NUMBER	MINI LAMINATE	LAMINATED SPROCKET NOSE	REPLACEABLE SPROCKET NOSE	HARD NOSE
----------------	-------------	-------	-------	-------------------	---------------	-------------------------	---------------------------	-----------

MARUYAMA

MODELS: POLE SAWS: MC-PL10, MC-PS10

10" (25.40cm)	40	3/8"LP	.050" (1,3mm)	15040TL	M1501040-1218TL			
---------------	----	--------	---------------	---------	-----------------	--	--	--

McCULLOCH

MODELS: 12A, 12S, EM12

12" (30.48cm)	44	3/8"LP	.050" (1,3mm)	15044TL	M1501244-1318TL			
---------------	----	--------	---------------	---------	-----------------	--	--	--

MODELS: 14A, 14S, EM16

14" (35.56cm)	49	3/8"LP	.050" (1,3mm)	15049TL	M1501449-1318TL			
16" (40.64cm)	54	3/8"LP	.050" (1,3mm)	15054TL	M1501654-1318TL			
18" (45.72cm)	60	3/8"LP	.050" (1,3mm)	15060TL	M1501860-1318TL			

MODELS: MS1015, MS1015P, MCP1510 POLE SAW

10" (25.40cm)	39	3/8"LP	.050" (1,3mm)	15039TL	M1501039-1318TL			
---------------	----	--------	---------------	---------	-----------------	--	--	--

MODELS: MS1630NT, MS1640NT

16" (40.64cm)	54	3/8"LP	.050" (1,3mm)	15054TL	M1501654-1318TL			
16" (40.64cm)	55	3/8"LP	.050" (1,3mm)	15055TL	M1501655-1318TL			

MODELS: EM 300S

14" (35.56cm)	50	3/8"LP	.050" (1,3mm)	15050TL	M1501450-1318TL			
16" (40.64cm)	55	3/8"LP	.050" (1,3mm)	15055TL	M1501655-1318TL			

MODELS: 2138, 3215, 3216, 3514, 3518, 3816, 3818AV, EAGER BEAVER, 2010, 2014, 2016, 2116, 2318, EB 2.3, EB 6A, MACCAT 16, 18, MC Series 110, 115, 120, 130, 140, 155, 160S, 165, 175, 310, 320, 340, 355, 365, 375, 430, 435, 440, 445, 510, 515, MCC1514, MINI MAC, MS1415, MS1420, MS1430, MS1432, MS1435, MS1455, MS1625M, MS1625AV, MS1635NAV, MS1635NAVXX, MS1645, MS1838, MS1838AVCC, MS1838AV, MS1842AVC, MS1846AVCC, PM380, PM400, POWER MAC Series 6, 145-14, 225-16, PROMAC Series 3200, 3205, 3205-14, 3210, 3212, 3214, 3216, 3219, 3505, 3800, 3805, 3818, 3850, SILVER EAGLE Series 2010, 2012, 2012S, 2014, 2014S, 2016, 2018S, 2316, SP-40, SUPER 16, SUPER 18, TITAN SERIES 35, 36, 37, 38, 39, 40, WILDCAT

12" (30.48cm)	44	3/8"LP	.050" (1,3mm)	15044TL	M1501244-1318TL			
14" (35.56cm)	49	3/8"LP	.050" (1,3mm)	15049TL	M1501449-1318TL			
14" (35.56cm)	50	3/8"LP	.050" (1,3mm)	15050TL	M1501450-1318TL			
16" (40.64cm)	54	3/8"LP	.050" (1,3mm)	15054TL	M1501654-1318TL			
16" (40.64cm)	55	3/8"LP	.050" (1,3mm)	15055TL	M1501655-1318TL			
18" (45.72cm)	60	3/8"LP	.050" (1,3mm)	15060TL	M1501860-1318TL			

MODELS: 10E, 12E, 14E, 16E, MCC3516, MCC3516F, MCC4516FK, MS1630NT, MS1640NT, MS1425, MS1630, MS1640

10" (25.40cm)	39	3/8"LP	.050" (1,3mm)	15039TL	M1501039-1318TL			
12" (30.48cm)	44	3/8"LP	.050" (1,3mm)	15044TL	M1501244-1318TL			
14" (35.56cm)	49	3/8"LP	.050" (1,3mm)	15049TL	M1501449-1318TL			
14" (35.56cm)	50	3/8"LP	.050" (1,3mm)	15050TL	M1501450-1318TL			
16" (40.64cm)	54	3/8"LP	.050" (1,3mm)	15054TL	M1501654-1318TL			
16" (40.64cm)	55	3/8"LP	.050" (1,3mm)	15055TL	M1501655-1318TL			
18" (45.72cm)	60	3/8"LP	.050" (1,3mm)	15060TL	M1501860-1318TL			

MODELS: PM380, PM400

16" (40.64cm)	54	3/8"LP	.050" (1,3mm)	15054TL	M1501654-1318TL			
16" (40.64cm)	55	3/8"LP	.050" (1,3mm)	15055TL	M1501655-1318TL			
18" (45.72cm)	60	3/8"LP	.050" (1,3mm)	15060TL	M1501860-1318TL			

MODELS: EB428, MS1434, MS1436, MS1636, MS1639NAVCC, MS1839, MS1842AVCC

14" (35.56cm)	49	3/8"LP	.050" (1,3mm)	15049TL	M1501449-1095TL			
16" (40.64cm)	54	3/8"LP	.050" (1,3mm)	15054TL	M1501654-1095TL			
18" (45.72cm)	60	3/8"LP	.050" (1,3mm)	15060TL	M1501860-1095TL			

McCULLOCH continued on page 58



CUTTING LENGTH	DRIVE LINKS	PITCH	GAUGE	CHAIN PART NUMBER	MINI LAMINATE	LAMINATED SPROCKET NOSE	REPLACEABLE SPROCKET NOSE	HARD NOSE
----------------	-------------	-------	-------	-------------------	---------------	-------------------------	---------------------------	-----------

McCULLOCH (cont.)

MODELS: EB356A, EB358, MAC CAT 438, MC3516, MC4218AV, MC1435A, MC1635A, MCC1840B, MP406, MS354A, MXC1840D, MXC1840DK, MS4016P, MS4018P

16" (40.64cm)	56	3/8" LP	.050" (1,3mm)	15056TL	M1501656-1041TL			
18" (45.72cm)	62	3/8" LP	.050" (1,3mm)	15062TL	M1501862-1041TL			

MODELS: 1849AV, 2046AV, 2049AV, 4600, 4700, 4900, 5000, 5500, MS1846AV, MS1849AV, MS1850, MS2046, MS2046AVCC, MS2049, MS22049AV, MS2049AVCC, MS2050, PM1845AV, PROMAC 40, 46, SILVER EAGLE, 2818, 3020, TIMBER BEAR 20

16" (40.64cm)	66	.325" NK	.050" (1,3mm)	25066NKTL		L2501666-11095TL		
16" (40.64cm)	66	.325"	.050" (1,3mm)	25066TL		L2501666-11095TL		
16" (40.64cm)	66	.325"	.058" (1,5mm)	25866TL		L2581666-11095TL	R258166-11095TL	H258166-11095TL
18" (45.72cm)	72	.325" NK	.050" (1,3mm)	25072NKTL		L2501872-11095TL		
18" (45.72cm)	72	.325"	.050" (1,3mm)	25072TL		L2501872-11095TL		
18" (45.72cm)	72	.325"	.058" (1,5mm)	25872TL		L2581872-11095TL	R2581872-11095TL	
20" (50.80cm)	78	.325"	.058" (1,5mm)	25878TL			R2582078-11095TL	H2582078-11095TL

MODELS: 1-10, 2-10, 3-10, 4-10, 5-10, 6-10, 7-10, 10-10, 10-10A, 55, PROMAC 55, 60, 555, 560, 570, 605, 610, 620, 650, 655, 700, 800, 805, 850, 1000, CP70, CP70L, DOUBLE EAGLE 50, DOUBLE EAGLE 80, EAGER BEAVER 3.7, PM605, PROMAC 5700, PROMAC 8200, SP60, SP70, SP80, SP81, SILVER EAGLE 3420, SILVER EAGLE 3720, TIMBER BEAR, TITAN 50, TITAN 57, TITAN 70

16" (40.64cm)	60	3/8"	.050" (1,3mm)	35060TL		L3501660-4176TL		
18" (45.72cm)	64	3/8"	.050" (1,3mm)	35064TL		L3501864-4176TL		
20" (50.80cm)	70	3/8"	.050" (1,3mm)	35070TL		L3502070-4176TL		

MODELS: 7-10, 560, 610, 620, 650, 655, 700, 800, 805, 850, 1000, CP70, CP70L, DOUBLE EAGLE 80, PROMAC 8200, SP70, SP80, SP81, TITAN 70

16" (40.64cm)	60	3/8"	.050" (1,3mm)	35060TL		L3501660-4176TL		
18" (45.72cm)	64	3/8"	.050" (1,3mm)	35064TL		L3501864-4176TL		
18" (45.72cm)	66	3/8"	.050" (1,3mm)	35066TL		L3501866-4176TL		
20" (50.80cm)	70	3/8"	.050" (1,3mm)	35070TL		L3502070-4176TL		

OLYMPYK / OLEO-MAC

MODELS: 240, 241, 244, 935, OLE 140F, OLE 300

14" (35.56cm)	50	3/8" LP	.050" (1,3mm)	15050TL	M1501450-1074TL			
16" (40.64cm)	55	3/8" LP	.050" (1,3mm)	15055TL	M1501655-1074TL			

MODELS: 938, 940C, 941, 945, 950, 951, 956, 962

16" (40.64cm)	66	.325" NK	.050" (1,3mm)	25066NKTL		L2501666-11095TL		
16" (40.64cm)	66	.325"	.050" (1,3mm)	25066TL		L2501666-11095TL		
16" (40.64cm)	66	.325"	.058" (1,5mm)	25866TL		L2581666-11095TL	R2581666-11095TL	H2581666-11095TL
18" (45.72cm)	72	.325" NK	.050" (1,3mm)	250NK72TL		L2501872-11095TL		
18" (45.72cm)	72	.325"	.050" (1,3mm)	25072TL		L2501872-11095TL		
18" (45.72cm)	72	.325"	.058" (1,5mm)	25872TL		L2581872-11095TL	R2581872-11095TL	
20" (50.80cm)	78	.325"	.050" (1,3mm)	25078TL		L2502078-11095TL		
20" (50.80cm)	78	.325"	.058" (1,5mm)	25878TL		L2582078-11095TL	R2582078-11095TL	H2582078-11095TL

MODELS: 250, 250A, 251, 252, 254, 260, 261, 264, 355, 460A, SUPER, 272, 280, 284, 461, 480A SUPER, 481, 970, 980, SUPER 482

16" (40.64cm)	59	3/8"	.050" (1,3mm)	35059TL		L3501659-4196TL		
---------------	----	------	---------------	---------	--	-----------------	--	--

MODELS: 999

21" (53.34cm)	68	.404"	.063" (1,6mm)	46368TL			R4632168-5031TL	H4632168-5031TL
25" (63.50cm)	80	.404"	.063" (1,6mm)	46380TL			R4632580-5031TL	H4632580-5031TL

PARTNER

MODELS: 365

14" (35.56cm)	52	3/8" LP	.050" (1,3mm)	15052TL	M1501452-1041TL			
---------------	----	---------	---------------	---------	-----------------	--	--	--

MODELS: 410, 510, 540

13" (33.02cm)	56	.325" NK	.050" (1,3mm)	25056NKTL		L2501356-11095TL		
15" (38.10cm)	64	.325" NK	.050" (1,3mm)	25064NKTL		L2501564-11095TL		

PARTNER continued on page 59

NOTE: Low kickback requirements in the ANSI standard apply to saw models less than 3.8 cubic inches (62cc). Low kickback performance requirements in the ANSI standard do not apply to saws larger than 3.8 cubic inches.



CUTTING LENGTH	DRIVE LINKS	PITCH	GAUGE	CHAIN PART NUMBER	MINI LAMINATE	LAMINATED SPROCKET NOSE	REPLACEABLE SPROCKET NOSE	HARD NOSE
----------------	-------------	-------	-------	-------------------	---------------	-------------------------	---------------------------	-----------

PARTNER (cont.)

MODELS: P-360, P-400, P-450, P-500, P-5000

13" (33.02cm)	56	.325" NK	.050" (1,3mm)	25056NKTL		L2501356-11095TL		
15" (38.10cm)	64	.325" NK	.050" (1,3mm)	25064NKTL		L2501564-11095TL		
15" (38.10cm)	64	.325"	.058" (1,5mm)	25864TL		L2581564-11095TL	R2581564-11095TL	H2581564-11095TL
16" (40.64cm)	66	.325" NK	.050" (1,3mm)	25066NKTL		L2501666-11095TL		
16" (40.64cm)	66	.325"	.050" (1,3mm)	25066TL		L2501666-11095TL		
16" (40.64cm)	66	.325"	.058" (1,5mm)	25866TL		L2581666-11095TL	R2581666-11095TL	H2581666-11095TL
18" (45.72cm)	72	.325" NK	.050" (1,3mm)	25072NKTL		L2501872-11095TL		
18" (45.72cm)	72	.325"	.050" (1,3mm)	25072TL		L2501872-11095TL		
18" (45.72cm)	72	.325"	.058" (1,5mm)	25872TL		L2581872-11095TL	R2581872-11095TL	
20" (50.80cm)	78	.325"	.050" (1,3mm)	25078TL		L2502078-11095TL		
20" (50.80cm)	78	.325"	.058" (1,5mm)	25878TL		L2582078-11095TL	R2582078-11095TL	H2582078-11095TL

MODELS: 550, 650, 1655, 2055, 7000, P-55, P-65, P-70, P-85, R-11, R-12, R-14, R-16, R-17, R-18, R-19, R-20, R-21, R-22, R-23, R-30, R-35, R-40, R-416, R-420, R-421, S-50, S-55, S-65

13" (33.02cm)	52	3/8"	.058" (1,5mm)	35852TL			R3581352-4009TL	H3581352-4009TL
15" (38.10cm)	56	3/8"	.058" (1,5mm)	35856TL		L3581556-4009TL	R3581556-4009TL	H3581556-4009TL
16" (40.64cm)	60	3/8"	.050" (1,3mm)	35060TL		L3501660-4009TL		
16" (40.64cm)	60	3/8"	.058" (1,5mm)	35860TL		L3581660-4009TL	R3581660-4009TL	H3581660-4009TL
18" (45.72cm)	68	3/8"	.050" (1,3mm)	35068TL		L3501868-4009TL		
18" (45.72cm)	68	3/8"	.058" (1,5mm)	35868TL		L3581868-4009TL	R3581868-4009TL	H3581868-4009TL
20" (50.80cm)	72	3/8"	.050" (1,3mm)	35072TL		L3502072-4009TL		
20" (50.80cm)	72	3/8"	.058" (1,5mm)	35872TL		L3582072-4009TL	R3582072-4009TL	H3582072-4009TL
20" (50.80cm)	72	3/8"	.063" (1,6mm)	36372TL		L3632072-4009TL	R3632072-4009TL	H3632072-4009TL

PIONEER

MODELS: 970, 1072, 1073, 1074, P20, P21, P25, P26, P28, P28S

13" (33.02cm)	56	.325" NK	.050" (1,3mm)	25056NKTL		L2501356-11095TL		
15" (38.10cm)	64	.325" NK	.050" (1,3mm)	25064NKTL		L2501564-11095TL		
15" (38.10cm)	64	.325"	.058" (1,5mm)	25864TL		L2581564-11095TL	R2581564-11095TL	H2581564-11095TL
16" (40.64cm)	66	.325" NK	.050" (1,3mm)	25066NKTL		L2501666-11095TL		
16" (40.64cm)	66	.325"	.050" (1,3mm)	25066TL		L2501666-11095TL		
16" (40.64cm)	66	.325"	.058" (1,5mm)	25866TL		L2581666-11095TL	R2581666-11095TL	H2581666-11095TL
18" (45.72cm)	72	.325" NK	.050" (1,3mm)	25072NKTL		L2501872-11095TL		
18" (45.72cm)	72	.325"	.050" (1,3mm)	25072TL		L2501872-11095TL		
18" (45.72cm)	72	.325"	.058" (1,5mm)	25872TL		L2581872-11095TL	R2581872-11095TL	
20" (50.80cm)	78	.325"	.050" (1,3mm)	25078TL		L2502078-11095TL		
20" (50.80cm)	78	.325"	.058" (1,5mm)	25878TL		L2582078-11095TL	R2582078-11095TL	H2582078-11095TL

POULAN

MODELS: POLE SAWS: 446T, PP445, PP258TP, PP5000P

8" (20.32cm)	33	3/8"LP NK	.043" (1,1mm)	14333TL	M1430833-1041TL			
10" (25.40cm)	40	3/8"LP NK	.043" (1,1mm)	14340TL	M1431040-1041TL			

MODELS: ES 300 (ELECTRIC), ES 350

8" (20.32cm)	33	3/8"LP NK	.043" (1,1mm)	14333TL	M1430833-1041TL			
10" (25.40cm)	40	3/8"LP NK	.043" (1,1mm)	14340TL	M1431040-1041TL			
16" (40.64cm)	56	3/8"LP NK	.043" (1,1mm)	14356TL	M1431656-1041TL			

MODELS: PLN1510, PLN1514, PLN3516F

10" (25.40cm)	39	3/8"LP	.050" (1,3mm)	15039TL	M1501039-1318TL			
12" (30.48cm)	44	3/8"LP	.050" (1,3mm)	15044TL	M1501244-1318TL			
14" (35.56cm)	49	3/8"LP	.050" (1,3mm)	15049TL	M1501449-1318TL			
14" (35.56cm)	50	3/8"LP	.050" (1,3mm)	15050TL	M1501450-1318TL			
16" (40.64cm)	54	3/8"LP	.050" (1,3mm)	15054TL	M1501654-1318TL			
16" (40.64cm)	55	3/8"LP	.050" (1,3mm)	15055TL	M1501655-1318TL			
18" (45.72cm)	60	3/8"LP	.050" (1,3mm)	15060TL	M1501860-1318TL			

POULAN continued on page 60



CUTTING LENGTH	DRIVE LINKS	PITCH	GAUGE	CHAIN PART NUMBER	MINI LAMINATE	LAMINATED SPROCKET NOSE	REPLACEABLE SPROCKET NOSE	HARD NOSE
----------------	-------------	-------	-------	-------------------	---------------	-------------------------	---------------------------	-----------

POULAN (cont.)

MODELS: 25A, 180, 190, 200, 205, 210, 220, 221, 222, 225, 230, 235, 236, 240, 250, 255, 260, 262, 400E, 1220, 1630, 1634, 1800, 1838, 1900, 1900LE, 1950, 1950LE, 1975, 1975LE, 2000, 2025, 2055LE, 2075, 2075C, 2150, 2155, 2160, 2175, 2250, 2250LE, 2300, 2350, 2375, 2375LE, 2450, 2550, 2550LE, 2555, 3314, 3314WS, 3314WSA, 3416, 3516, 3516PR, 3516AVX, 3816, 3816AV, 3818, 4018, 4018WT, 4218, 4218AV, 4218AVX, E14E, E16E, ES350, ES400, MICRO 25, S23, S25, S25AV, S25CVA, S25D, S25DA, S35, ELECTRIC MODELS 1420, 1425, 1625, 2100, 2400, 2500, 2600, PRO 440E, PATRIOT 1900, PP3516AVX, WILDTHING, WOODSHARK

10" (25.40cm)	40	3/8" LP NK	.043" (1,1mm)	14340TL	M1431040-1041TL			
10" (25.40cm)	40	3/8" LP	.050" (1,3mm)	15040TL	M1501040-1041TL	L1501040-1041TL		
12" (30.48cm)	45	3/8" LP NK	.043" (1,1mm)	14345TL	M1431245-1041TL			
12" (30.48cm)	45	3/8" LP	.050" (1,3mm)	15045TL	M1501245-1041TL	L1501245-1041TL		
14" (35.56cm)	52	3/8" LP NK	.043" (1,1mm)	14352TL	M1431452-1041TL			
14" (35.56cm)	52	3/8" LP	.050" (1,3mm)	15052TL	M1501452-1041TL	L1501452-1041TL		
16" (40.64cm)	56	3/8" LP	.050" (1,3mm)	15056TL	M1501656-1041TL	L1501656-1041TL		
18" (45.72cm)	62	3/8" LP	.050" (1,3mm)	15062TL	M1501862-1041TL	L1501862-1041TL		

MODELS: 255, 285, 295, 305, 306SA, 310, 335 PREDATOR, 336, 2700, 2750, 2775, 2800, 2900 FARM HAND, 3000, 3050, 3100, 3300, 4600, 4620, 4620AV, 4620AVX

13" (33.02cm)	56	.325" NK	.050" (1,3mm)	25056NKTL		L2501356-11041TL		
15" (38.10cm)	64	.325" NK	.050" (1,3mm)	25064NKTL		L2501564-11041TL		
16" (40.64cm)	66	.325" NK	.050" (1,3mm)	25066NKTL		L2501666-11041TL		
16" (40.64cm)	66	.325"	.050" (1,3mm)	25066TL		L2501666-11041TL		
20" (50.80cm)	78	.325"	.050" (1,3mm)	25078TL		L2502078-11041TL		

MODELS: 325

13" (33.02cm)	56	.325" NK	.050" (1,3mm)	25056NKTL		L2501356-11095TL		
15" (38.10cm)	64	.325" NK	.050" (1,3mm)	25064NKTL		L2501564-11095TL		
15" (38.10cm)	64	.325"	.058" (1,5mm)	25864TL		L2581564-11095TL	R2581564-11095TL	H2581564-11095TL
16" (40.64cm)	66	.325" NK	.050" (1,3mm)	25066NKTL		L2501666-11095TL		
16" (40.64cm)	66	.325"	.050" (1,3mm)	25066TL		L2501666-11095TL		
16" (40.64cm)	66	.325"	.058" (1,5mm)	25866TL		L2581666-11095TL	R2581666-11095TL	H2581666-11095TL
18" (45.72cm)	72	.325" NK	.050" (1,3mm)	25072NKTL		L2501872-11095TL		
18" (45.72cm)	72	.325"	.050" (1,3mm)	25072TL		L2501872-11095TL		
18" (45.72cm)	72	.325"	.058" (1,5mm)	25872TL		L2581872-11095TL	R2581872-11095TL	
20" (50.80cm)	78	.325"	.050" (1,3mm)	25078TL		L2502078-11095TL		
20" (50.80cm)	78	.325"	.058" (1,5mm)	25878TL		L2582078-11095TL	R2582078-11095TL	H2582078-11095TL

MODELS: 203, 245, 306, 306A, 360, 361, 375, 385, 400, 445, 446, 450, 3400, 3800, 395, 3900, 4000, 4200, 4400, 4900, 5200, 5400, 5500, 6700

16" (40.64cm)	60	3/8"	.050" (1,3mm)	35060TL		L3501660-4176TL		
18" (45.72cm)	66	3/8"	.050" (1,3mm)	35066TL		L3501866-4176TL		
20" (50.80cm)	70	3/8"	.050" (1,3mm)	35070TL		L3502070-4176TL		

MODELS: 415, 425, 445, 475, 505

13" (33.02cm)	52	3/8"	.058" (1,5mm)	35852TL			R3581352-4009TL	H3581352-4009TL
15" (38.10cm)	56	3/8"	.058" (1,5mm)	35856TL		L3581556-4009TL	R3581556-4009TL	H3581556-4009TL
16" (40.64cm)	60	3/8"	.050" (1,3mm)	35060TL		L3501660-4009TL		
16" (40.64cm)	60	3/8"	.058" (1,5mm)	35860TL		L3581660-4009TL	R3581660-4009TL	H3581660-4009TL
18" (45.72cm)	68	3/8"	.050" (1,3mm)	35068TL		L3501868-4009TL		
18" (45.72cm)	68	3/8"	.058" (1,5mm)	35868TL		L3581868-4009TL	R3581868-4009TL	H3581868-4009TL
20" (50.80cm)	72	3/8"	.050" (1,3mm)	35072TL		L3502072-4009TL		
20" (50.80cm)	72	3/8"	.058" (1,5mm)	35872TL		L3582072-4009TL	R3582072-4009TL	H3582072-4009TL
20" (50.80cm)	72	3/8"	.063" (1,6mm)	36372TL		L3632072-4009TL	R3632072-4009TL	H3632072-4009TL
24" (60.96cm)	84	3/8"	.058" (1,5mm)	35884TL			R3582484-4009TL	
24" (60.96cm)	84	3/8"	.063" (1,6mm)	36384TL			R3632484-4009TL	H3632484-4009TL
28" (71.12cm)	92	3/8"	.058" (1,5mm)	35892TL			R3582892-4009TL	H3582892-4009TL
28" (71.12cm)	92	3/8"	.063" (1,6mm)	36392TL			R3632892-4009TL	H3632892-4009TL
28" (71.12cm)	93	3/8"	.063" (1,6mm)	36393TL				H3632893-4009TL
36" (91.44cm)	115	3/8"	.058" (1,5mm)	358115TL			R35836115-4009TL	H35836115-4009TL
36" (91.44cm)	115	3/8"	.063" (1,6mm)	363115TL			R36336115-4009TL	H36336115-4009TL

POULAN continued on page 61

NOTE: Low kickback requirements in the ANSI standard apply to saw models less than 3.8 cubic inches (62cc). Low kickback performance requirements in the ANSI standard do not apply to saws larger than 3.8 cubic inches.



CUTTING LENGTH	DRIVE LINKS	PITCH	GAUGE	CHAIN PART NUMBER	MINI LAMINATE	LAMINATED SPROCKET NOSE	REPLACEABLE SPROCKET NOSE	HARD NOSE
----------------	-------------	-------	-------	-------------------	---------------	-------------------------	---------------------------	-----------

POULAN (cont.)

MODELS: 6900, 7700, 8500

20" (50.80cm)	70	3/8"	.058" (1,5mm)	35870TL			R3582070-4196TL	H3582070-4196TL
---------------	----	------	---------------	---------	--	--	-----------------	-----------------

MODELS: 415, 425, 475, 505

15" (38.10cm)	56	3/8"	.058" (1,5mm)	35856TL		L3581556-4009TL	R3581556-4009TL	H3581556-4009TL
16" (40.64cm)	60	3/8"	.050" (1,3mm)	35060TL		L3501660-4009TL		
16" (40.64cm)	60	3/8"	.058" (1,5mm)	35860TL		L3581660-4009TL	R3581660-4009TL	H3581660-4009TL
18" (45.72cm)	68	3/8"	.050" (1,3mm)	35068TL		L3501868-4009TL		
18" (45.72cm)	68	3/8"	.058" (1,5mm)	35868TL		L3581868-4009TL	R3581868-4009TL	H3581868-4009TL
20" (50.80cm)	72	3/8"	.050" (1,3mm)	35072TL		L3502072-4009TL		
20" (50.80cm)	72	3/8"	.058" (1,5mm)	35872TL		L3582072-4009TL	R3582072-4009TL	H3582072-4009TL
20" (50.80cm)	72	3/8"	.063" (1,6mm)	36372TL		L3632072-4009TL	R3632072-4009TL	H3632072-4009TL
24" (60.96cm)	84	3/8"	.058" (1,5mm)	35884TL			R3582484-4009TL	
24" (60.96cm)	84	3/8"	.063" (1,6mm)	36384TL			R3632484-4009TL	H3632484-4009TL
28" (71.12cm)	92	3/8"	.058" (1,5mm)	35892TL			R3582892-4009TL	H3582892-4009TL
28" (71.12cm)	92	3/8"	.063" (1,6mm)	36392TL			R3632892-4009TL	H3632892-4009TL
28" (71.12cm)	93	3/8"	.063" (1,6mm)	36393TL				H3632893-4009TL
36" (91.44cm)	115	3/8"	.058" (1,5mm)	358115TL			R35836115-4009TL	H35836115-4009TL
36" (91.44cm)	115	3/8"	.063" (1,6mm)	363115TL			R36336115-4009TL	H36336115-4009TL

MODELS: MICRO 25PS

14" (35.56cm)	52	3/8"LP	.050" (1,3mm)	15052TL	M1501452-1041TL			
---------------	----	--------	---------------	---------	-----------------	--	--	--

POWER PRUNER

MODELS: PPF-280, PPT-280, PPT-265, PPT-265H, PPT-265S

10" (25.40cm)	40	3/8"LP NK	.043" (1,1mm)	14340TL	M1431040-1041TL			
10" (25.40cm)	40	3/8"LP	.050" (1,3mm)	15040TL	M1501040-1041TL			
12" (30.48cm)	45	3/8"LP NK	.043" (1,1mm)	14345TL	M1431245-1041TL			
12" (30.48cm)	45	3/8"LP	.050" (1,3mm)	15045TL	M1501245-1041TL			
14" (35.56cm)	52	3/8"LP NK	.043" (1,1mm)	14352TL	M1431452-1041TL			
14" (35.56cm)	52	3/8"LP	.050" (1,3mm)	15052TL	M1501452-1041TL			

POWERHORSE

MODELS: 190500, 190501, 190555, 190556

14" (35.56cm)	52	3/8"LP	.050" (1,3mm)	15052TL	M1501452-1041TL			
16" (40.64cm)	56	3/8"LP	.050" (1,3mm)	15056TL	M1501656-1041TL			

MODELS: 190502, 190503, 190557, 190559

18" (45.72cm)	72	.325"	.050" (1,3mm)	25072TL		L2501872-11095TL		
18" (45.72cm)	72	.325"	.058" (1,5mm)	25872TL		L2581872-11095TL	R2581872-11095TL	
20" (50.80cm)	78	.325"	.050" (1,3mm)	25078TL		L2502078-11095TL		
20" (50.80cm)	78	.325"	.058" (1,5mm)	25878TL			R2582078-11095TL	H2582078-11095TL

REDMAX

MODELS: POLE SAWS: PRO GZ25N, PSZ 2500S

10" (25.40cm)	40	3/8"LP NK	.043" (1,1mm)	14340TL	M1431040-1218TL			
---------------	----	-----------	---------------	---------	-----------------	--	--	--

MODELS: G250, G300AVS, G300TS, G310TS, G2500, G2500TS, G3100TS, G3200EZ, G3300EZ, GZ3500T, G3800, G3800AVS, GZ400, GZ4000

10" (25.40cm)	40	3/8"LP	.050" (1,3mm)	15040TL	M1501040-1041TL	L1501040-1041TL		
12" (30.48cm)	45	3/8"LP NK	.043" (1,1mm)	14345TL	M1431245-1041TL			
12" (30.48cm)	45	3/8"LP	.050" (1,3mm)	15045TL	M1501245-1041TL	L1501245-1041TL		
14" (35.56cm)	52	3/8"LP NK	.043" (1,1mm)	14352TL	M1431452-1041TL			
14" (35.56cm)	52	3/8"LP	.050" (1,3mm)	15052TL	M1501452-1041TL	L1501452-1041TL		
16" (40.64cm)	56	3/8"LP NK	.043" (1,1mm)	14356TL	M1431656-1041TL			
16" (40.64cm)	56	3/8"LP	.050" (1,3mm)	15056TL	M1501656-1041TL	L1501656-1041TL		
18" (45.72cm)	62	3/8"LP	.050" (1,3mm)	15062TL	M1501862-1041TL	L1501862-1041TL		

REDMAX continued on page 62



CUTTING LENGTH	DRIVE LINKS	PITCH	GAUGE	CHAIN PART NUMBER	MINI LAMINATE	LAMINATED SPROCKET NOSE	REPLACEABLE SPROCKET NOSE	HARD NOSE
----------------	-------------	-------	-------	-------------------	---------------	-------------------------	---------------------------	-----------

REDMAX (cont.)

MODELS: G390, G450AVS, G455AVS, G5000, G5000AVS, G5300

15" (38.10cm)	64	.325" NK	.050" (1,3mm)	25064NKTL		L2501564-11095TL		
15" (38.10cm)	64	.325"	.058" (1,5mm)	25864TL		L2581564-11095TL	R2581564-11095TL	H2581564-11095TL
16" (40.64cm)	66	.325" NK	.050" (1,3mm)	25066NKTL		L2501666-11095TL		
16" (40.64cm)	66	.325"	.050" (1,3mm)	25066TL		L2501666-11095TL		
16" (40.64cm)	66	.325"	.058" (1,5mm)	25866TL		L2581666-11095TL	R2581666-11095TL	H2581666-11095TL
18" (45.72cm)	72	.325" NK	.050" (1,3mm)	25072NKTL		L2501872-11095TL		
18" (45.72cm)	72	.325"	.050" (1,3mm)	25072TL		L2501872-11095TL		
18" (45.72cm)	72	.325"	.058" (1,5mm)	25872TL		L2581872-11095TL	R2581872-11095TL	
20" (50.80cm)	78	.325"	.050" (1,3mm)	25078TL		L2502078-11095TL		
20" (50.80cm)	78	.325"	.058" (1,5mm)	25878TL		L2582078-11095TL	R2582078-11095TL	H2582078-11095TL

MODELS: GZ4500

16" (40.64cm)	66	.325"	.050" (1,3mm)	25066TL		L2501666-11041TL		
---------------	----	-------	---------------	---------	--	------------------	--	--

MODELS: G621AVS

16" (40.64cm)	60	3/8"	.050" (1,3mm)	35060TL		L3501660-4176TL		
18" (45.72cm)	66	3/8"	.050" (1,3mm)	35066TL		L3501866-4176TL		
20" (50.80cm)	70	3/8"	.050" (1,3mm)	35070TL		L3502070-4176TL		

MODELS: GZ7000

18" (45.72cm)	68	3/8"	.050" (1,3mm)	35068TL		L3501868-4009TL		
20" (50.80cm)	72	3/8"	.050" (1,3mm)	35072TL		L3502072-4009TL		

REMINGTON

MODELS: 100, 500, 812, 814, 816, 840AV, 850AV, 860AV, JOB MASTER, OUTDOORSMAN II, RANCHER, WEEKENDER, YARDMASTER

12" (30.48cm)	44	3/8"LP	.050" (1,3mm)	15044TL	M1501244-1318TL			
14" (35.56cm)	49	3/8"LP	.050" (1,3mm)	15049TL	M1501449-1318TL			
14" (35.56cm)	50	3/8"LP	.050" (1,3mm)	15050TL	M1501450-1318TL			
16" (40.64cm)	54	3/8"LP	.050" (1,3mm)	15054TL	M1501654-1318TL			
16" (40.64cm)	55	3/8"LP	.050" (1,3mm)	15055TL	M1501655-1318TL			

MODELS: RM5118

16" (40.64cm)	66	.325"	.050" (1,3mm)	25066TL		L2501666-11095TL		
18" (45.72cm)	72	.325"	.050" (1,3mm)	25072TL		L2501872-11095TL		

RYOBI

MODELS: PCN 3335, APR02

10" (25.40cm)	40	3/8"LP	.050" (1,3mm)	15040TL	M1501040-1041TL			
12" (30.48cm)	45	3/8"LP	.050" (1,3mm)	15045TL	M1501245-1041TL			
14" (35.56cm)	52	3/8"LP	.050" (1,3mm)	15052TL	M1501452-1041TL			
16" (40.64cm)	57	3/8"LP	.050" (1,3mm)	15057TL	M1501657-1041TL			

MODELS: CSE5145, CSE5650

16" (40.64cm)	66	.325"	.058" (1,5mm)	25866TL		L2581666-11041TL		
18" (45.72cm)	72	.325"	.058" (1,5mm)	25872TL		L2581872-11041TL	R2581872-11041TL	H2581872-11041TL
20" (50.80cm)	78	.325"	.058" (1,5mm)	25878TL		L2582078-11041TL		

MODELS: PCN 4040

16" (40.64cm)	66	.325"	.058" (1,5mm)	25866TL		L2581666-11041TL		
18" (45.72cm)	72	.325"	.058" (1,5mm)	25872TL		L2581872-11041TL	R2581872-11041TL	H2581872-11041TL

NOTE: Low kickback requirements in the ANSI standard apply to saw models less than 3.8 cubic inches (62cc). Low kickback performance requirements in the ANSI standard do not apply to saws larger than 3.8 cubic inches.



CUTTING LENGTH	DRIVE LINKS	PITCH	GAUGE	CHAIN PART NUMBER	MINI LAMINATE	LAMINATED SPROCKET NOSE	REPLACEABLE SPROCKET NOSE	HARD NOSE
----------------	-------------	-------	-------	-------------------	---------------	-------------------------	---------------------------	-----------

SEARS (CRAFTSMAN)

MODELS: POLE SAWS: 79245, 79246, 79240

8" (20.32cm)	33	3/8"LP NK	.043" (1,1mm)	14333TL	M1430833-1041TL			
10" (25.40cm)	40	3/8"LP NK	.043" (1,1mm)	14340TL	M1431040-1041TL			

MODELS: 35265, 35507PS

16" (40.64cm)	56	3/8"LP	.050" (1,3mm)	15056TL	M1501656-1041TL			
---------------	----	--------	---------------	---------	-----------------	--	--	--

MODELS: 3400, 3401, 3402, 3407, 3144, 3412, 3214, 3415, 3425, 3445, 3455, 3460, 3461, 3476, 34071, 34094, 34101, 34102, 34104, 34106, 34108, 34109, 34111, 34114, 34115, 34116, 34117, 34118, 34124, 34150, 34180, 34181, 35006, 35008, 35018, 35023, 35024, 35026, 35027, 35028, 35036, 35037, 35038, 35044, 35046, 35048, 35056, 35058, 35060, 35066, 35067, 35080, 35081, 35082, 35083, 35087, 35088, 35091, 35093, 35095, 35096, 35099, 35104, 35106, 35108, 35114, 35115, 35116, 35117, 35118, 35134, 35136, 35138, 35144, 35145, 35146, 35148, 35156, 35158, 35160, 35161, 35170, 35171, 35180, 35181, 35182, 35190, 35191, 35198, 35202, 35203, 35205, 35206, 35207, 35209, 35211, 35215, 35216, 35218, 35219, 35224, 35231, 35232, 35235, 35238, 35263, 35266, 35267, 35268, 35269, 35270, 35273, 35280, 35281, 35283, 35363, 35366, 35367, 35504, 35505, 35506, 35508, 35512, 35514, 35515, 35516, 35623, 35624, 35713, 35714, 35717, 35718, 35723, 35736, 35802, 35824, 35841, 35886, 36010, 36012, 36013, 36015, 36017, 36018, 36023, 36028, 36036, 36038, 36068, 36069, 36080, 36082, 36083, 36085, 36087, 36088, 36218

12" (30.48cm)	45	3/8"LP NK	.043" (1,1mm)	14345TL	M1431245-1041TL			
12" (30.48cm)	45	3/8"LP	.050" (1,3mm)	15045TL	M1501245-1041TL	L1501245-1041TL		
14" (35.56cm)	52	3/8"LP NK	.043" (1,1mm)	14352TL	M1431452-1041TL			
14" (35.56cm)	52	3/8"LP	.050" (1,3mm)	15052TL	M1501452-1041TL	L1501452-1041TL		
16" (40.64cm)	56	3/8"LP NK	.043" (1,1mm)	14356TL	M1431656-1041TL			
16" (40.64cm)	56	3/8"LP	.050" (1,3mm)	15056TL	M1501656-1041TL	L1501656-1041TL		
18" (45.72cm)	62	3/8"LP	.050" (1,3mm)	15062TL	M1501862-1041TL			

MODELS: 35084, 35085, 41AY85AR799

18" (45.72cm)	72	.325" NK	.050" (1,3mm)	25072NKTL		L2501872-11095TL		
---------------	----	----------	---------------	-----------	--	------------------	--	--

MODELS: 35020, 35021, 35119, 35120, 35121, 35492, 35607, 35624, 35607, 35628, 35623

16" (40.64cm)	66	.325"	.050" (1,3mm)	25066TL		L2501666-11041TL		
18" (45.72cm)	72	.325"	.050" (1,3mm)	25072TL		L2501872-11041TL		
20" (50.80cm)	78	.325"	.050" (1,3mm)	25078TL		L2502078-11041TL		

MODELS: 35212, 35483, 35608, 35609, 35690, 35721, 35727, 35728, 35826, 35829, 35851, 35881, 35885, Electrics (1983 and later), 35887, 35889

16" (40.64cm)	60	3/8"	.050" (1,3mm)	35060TL		L3501660-4176TL		
18" (45.72cm)	64	3/8"	.050" (1,3mm)	35064TL		L3501864-4176TL		
18" (45.72cm)	66	3/8"	.050" (1,3mm)	35066TL		L3501866-4176TL		
20" (50.80cm)	70	3/8"	.050" (1,3mm)	35070TL		L3502070-4176TL		

SHINDAIWA

MODELS: 90, 100, 110, 120, 140, 150 ELECTRIC, 285S, 300, 300S

12" (30.48cm)	45	3/8"LP NK	.043" (1,1mm)	14345TL	M1431245-1041TL			
12" (30.48cm)	45	3/8"LP	.050" (1,3mm)	15045TL	M1501245-1041TL	L1501245-1041TL		
14" (35.56cm)	52	3/8"LP NK	.043" (1,1mm)	14352TL	M1431452-1041TL			
14" (35.56cm)	52	3/8"LP	.050" (1,3mm)	15052TL	M1501452-1041TL	L1501452-1041TL		
16" (40.64cm)	56	3/8"LP NK	.043" (1,1mm)	14356TL	M1431656-1041TL			
16" (40.64cm)	56	3/8"LP	.050" (1,3mm)	15056TL	M1501656-1041TL	L1501656-1041TL		
18" (45.72cm)	62	3/8"LP	.050" (1,3mm)	15062TL	M1501862-1041TL	L1501862-1041TL		

MODELS: 104P, 180, 345, 350, 352, 352S, 357, 360, E350AV

14" (35.56cm)	52	3/8"LP	.050" (1,3mm)	15052TL	M1501452-1041TL	L1501452-1041TL		
16" (40.64cm)	56	3/8"LP	.050" (1,3mm)	15056TL	M1501656-1041TL			
16" (40.64cm)	57	3/8"LP	.050" (1,3mm)	15057TL	M1501657-1041TL	L1501657-1041TL		
18" (45.72cm)	62	3/8"LP	.050" (1,3mm)	15062TL	M1501862-1041TL			

SHINDAIWA continued on page 64



CUTTING LENGTH	DRIVE LINKS	PITCH	GAUGE	CHAIN PART NUMBER	MINI LAMINATE	LAMINATED SPROCKET NOSE	REPLACEABLE SPROCKET NOSE	HARD NOSE
----------------	-------------	-------	-------	-------------------	---------------	-------------------------	---------------------------	-----------

SHINDAIWA (cont.)

MODELS: 360, 366, 377, 400, 415, 416, 446S, 450, 451, 488, 488S, 490, 500

15" (38.10cm)	64	.325" NK	.050" (1,3mm)	25064NKTL		L2501564-11041TL		
16" (40.64cm)	66	.325" NK	.050" (1,3mm)	25066NKTL		L2501666-11041TL		
16" (40.64cm)	66	.325"	.050" (1,3mm)	25066TL		L2501666-11041TL		
18" (45.72cm)	72	.325"	.050" (1,3mm)	25072TL		L2501872-11041TL		
20" (50.80cm)	78	.325"	.050" (1,3mm)	25078TL		L2502078-11041TL		

MODELS: 550, 575, 577

13" (33.02cm)	52	3/8"	.058" (1,5mm)	35852TL			R3581352-4009TL	H3581352-4009TL
15" (38.10cm)	56	3/8"	.058" (1,5mm)	35856TL		L3581556-4009TL	R3581556-4009TL	H3581556-4009TL
16" (40.64cm)	60	3/8"	.058" (1,5mm)	35860TL		L3581660-4009TL	R3581660-4009TL	H3581660-4009TL
18" (45.72cm)	68	3/8"	.058" (1,5mm)	35868TL		L3581868-4009TL	R3581868-4009TL	H3581868-4009TL
20" (50.80cm)	72	3/8"	.058" (1,5mm)	35872TL		L3582072-4009TL	R3582072-4009TL	H3582072-4009TL
24" (60.96cm)	84	3/8"	.058" (1,5mm)	35884TL			R3582484-4009TL	H3582484-4009TL
28" (71.12cm)	92	3/8"	.058" (1,5mm)	35892TL			R3582892-4009TL	H3582892-4009TL

MODELS: 680, 695, 757, 757C, 757W

13" (33.02cm)	52	3/8"	.058" (1,5mm)	35852TL			R3581352-4009TL	H3581352-4009TL
15" (38.10cm)	56	3/8"	.058" (1,5mm)	35856TL		L3581556-4009TL	R3581556-4009TL	H3581556-4009TL
16" (40.64cm)	60	3/8"	.050" (1,3mm)	35060TL		L3501660-4009TL		
16" (40.64cm)	60	3/8"	.058" (1,5mm)	35860TL		L3581660-4009TL	R3581660-4009TL	H3581660-4009TL
18" (45.72cm)	68	3/8"	.050" (1,3mm)	35068TL		L3501868-4009TL		
18" (45.72cm)	68	3/8"	.058" (1,5mm)	35868TL		L3581868-4009TL	R3581868-4009TL	H3581868-4009TL
20" (50.80cm)	65	.404"	.063" (1,6mm)	46365TL			R4632065-4009TL	H4632065-4009TL
20" (50.80cm)	72	3/8"	.050" (1,3mm)	35072TL		L3502072-4009TL		
20" (50.80cm)	72	3/8"	.058" (1,5mm)	35872TL		L3582072-4009TL	R3582072-4009TL	H3582072-4009TL
20" (50.80cm)	72	3/8"	.063" (1,6mm)	36372TL		L3632072-4009TL	R3632072-4009TL	H3632072-4009TL
24" (60.96cm)	84	3/8"	.058" (1,5mm)	35884TL			R3582484-4009TL	H3582484-4009TL
24" (60.96cm)	84	3/8"	.063" (1,6mm)	36384TL			R3632484-4009TL	H3632484-4009TL
28" (71.12cm)	92	3/8"	.058" (1,5mm)	35892TL			R3582892-4009TL	H3582892-4009TL
28" (71.12cm)	92	3/8"	.063" (1,6mm)	36392TL			R3632892-4009TL	H3632892-4009TL
28" (71.12cm)	93	3/8"	.063" (1,6mm)	36393TL				H3632893-4009TL
36" (91.44cm)	115	3/8"	.058" (1,5mm)	358115TL				H35836115-4009TL
36" (91.44cm)	115	3/8"	.063" (1,6mm)	363115TL				H36336115-4009TL

SKIL

MODELS: 1620, 1622, 1624, 1631, TYPE 3, 1634, 1635, 1636

12" (30.48cm)	45	3/8"LP NK	.043" (1,1mm)	14345TL	M1431245-1041TL			
12" (30.48cm)	45	3/8"LP	.050" (1,3mm)	15045TL	M1501245-1041TL	L1501245-1041TL		
14" (35.56cm)	52	3/8"LP NK	.043" (1,1mm)	14352TL	M1431452-1041TL			
14" (35.56cm)	52	3/8"LP	.050" (1,3mm)	15052TL	M1501452-1041TL	L1501452-1041TL		
16" (40.64cm)	56	3/8"LP NK	.043" (1,1mm)	14356TL	M1431656-1041TL			
16" (40.64cm)	56	3/8"LP	.050" (1,3mm)	15056TL	M1501656-1041TL	L1501656-1041TL		
18" (45.72cm)	62	3/8"LP	.050" (1,3mm)	15062TL	M1501862-1041TL			

MODELS: 1641

16" (40.64cm)	60	3/8"	.050" (1,3mm)	35060TL		L3501660-4176TL		
18" (45.72cm)	64	3/8"	.050" (1,3mm)	35064TL		L3501864-4176TL		
18" (45.72cm)	66	3/8"	.050" (1,3mm)	35066TL		L3501866-4176TL		
20" (50.80cm)	70	3/8"	.050" (1,3mm)	35070TL		L3502070-4176TL		

NOTE: Low kickback requirements in the ANSI standard apply to saw models less than 3.8 cubic inches (62cc). Low kickback performance requirements in the ANSI standard do not apply to saws larger than 3.8 cubic inches.



CUTTING LENGTH	DRIVE LINKS	PITCH	GAUGE	CHAIN PART NUMBER	MINI LAMINATE	LAMINATED SPROCKET NOSE	REPLACEABLE SPROCKET NOSE	HARD NOSE
----------------	-------------	-------	-------	-------------------	---------------	-------------------------	---------------------------	-----------

SNAPPER

MODELS: S1634, S1838

10" (25.40cm)	40	3/8"LP NK	.043" (1,1mm)	14340TL	M1431040-1041TL			
10" (25.40cm)	40	3/8"LP	.050" (1,3mm)	15040TL	M1501040-1041TL	L1501040-1041TL		
12" (30.48cm)	45	3/8"LP NK	.043" (1,1mm)	14345TL	M1431245-1041TL			
12" (30.48cm)	45	3/8"LP	.050" (1,3mm)	15045TL	M1501245-1041TL	L1501245-1041TL		
14" (35.56cm)	52	3/8"LP NK	.043" (1,1mm)	14352TL	M1431452-1041TL			
14" (35.56cm)	52	3/8"LP	.050" (1,3mm)	15052TL	M1501452-1041TL	L1501452-1041TL		
16" (40.64cm)	56	3/8"LP NK	.043" (1,1mm)	14356TL	M1431656-1041TL			
16" (40.64cm)	56	3/8"LP	.050" (1,3mm)	15056TL	M1501656-1041TL	L1501656-1041TL		
18" (45.72cm)	62	3/8"LP	.050" (1,3mm)	15062TL	M1501862-1041TL	L1501862-1041TL		

SOLO

MODELS: 630, 633, 635, 636, 637, 643

12" (30.48cm)	45	3/8"LP	.050" (1,3mm)	15045TL	M1501245-1095TL			
14" (35.56cm)	52	3/8"LP NK	.043" (1,1mm)	14352TL	M1431452-1095TL			
14" (35.56cm)	52	3/8"LP	.050" (1,3mm)	15052TL	M1501452-1095TL			
16" (40.64cm)	56	3/8"LP	.050" (1,3mm)	15056TL	M1501656-1095TL			
18" (45.72cm)	62	3/8"LP	.050" (1,3mm)	15062TL	M1501862-1095TL			

MODELS: 603, 662, 665, 667, 670, 675, 680, 681, 690, 694

13" (33.02cm)	52	3/8"	.058" (1,5mm)	35852TL			R3581352-4009TL	H3581352-4009TL
15" (38.10cm)	56	3/8"	.058" (1,5mm)	35856TL		L3581556-4009TL	R3581556-4009TL	H3581556-4009TL
16" (40.64cm)	60	3/8"	.050" (1,3mm)	35060TL		L3501660-4009TL		
16" (40.64cm)	60	3/8"	.058" (1,5mm)	35860TL		L3581660-4009TL	R3581660-4009TL	H3581660-4009TL
18" (45.72cm)	68	3/8"	.050" (1,3mm)	35068TL		L3501868-4009TL		
18" (45.72cm)	68	3/8"	.058" (1,5mm)	35868TL		L3581868-4009TL	R3581868-4009TL	H3581868-4009TL
20" (50.80cm)	65	.404"	.063" (1,6mm)	46365TL				H4632065-4009TL
20" (50.80cm)	72	3/8"	.050" (1,3mm)	35072TL		L3502072-4009TL		
20" (50.80cm)	72	3/8"	.058" (1,5mm)	35872TL		L3582072-4009TL	R3582072-4009TL	H3582072-4009TL
20" (50.80cm)	72	3/8"	.063" (1,6mm)	36372TL		L3632072-4009TL	R3632072-4009TL	H3632072-4009TL
24" (60.96cm)	84	3/8"	.058" (1,5mm)	35884TL			R3582484-4009TL	H3582484-4009TL
24" (60.96cm)	84	3/8"	.063" (1,6mm)	36384TL			R3632484-4009TL	H3632484-4009TL
28" (71.12cm)	92	3/8"	.058" (1,5mm)	35892TL			R3582892-4009TL	H3582892-4009TL
28" (71.12cm)	92	3/8"	.063" (1,6mm)	36392TL			R3632892-4009TL	H3632892-4009TL
28" (71.12cm)	93	3/8"	.063" (1,6mm)	36393TL				H3632893-4009TL
36" (91.44cm)	115	3/8"	.058" (1,5mm)	358115TL				H35836115-4009TL
36" (91.44cm)	115	3/8"	.063" (1,6mm)	363115TL				H36336115-4009TL

MODELS: 613, 614, 631, 632, 634, 638, 639, 641, 644, 645, 647, 650, 651, 652, 651SP, 654, 656, 656SP

16" (40.64cm)	66	.325"	.050" (1,3mm)	25066TL		L2501666-11095TL		
16" (40.64cm)	66	.325"	.058" (1,5mm)	25866TL		L2581666-11095TL	R2581666-11095TL	H2581666-11095TL
18" (45.72cm)	72	.325"	.050" (1,3mm)	25072TL		L2501872-11095TL		
18" (45.72cm)	72	.325"	.058" (1,5mm)	25872TL		L2581872-11095TL	R2581872-11095TL	H2581872-11095TL
20" (50.80cm)	78	.325"	.050" (1,3mm)	25078TL		L2502078-11095TL		
20" (50.80cm)	78	.325"	.058" (1,5mm)	25878TL		L2582078-11095TL	R2582078-11095TL	H2582078-11095TL



CUTTING LENGTH	DRIVE LINKS	PITCH	GAUGE	CHAIN PART NUMBER	MINI LAMINATE	LAMINATED SPROCKET NOSE	REPLACEABLE SPROCKET NOSE	HARD NOSE
----------------	-------------	-------	-------	-------------------	---------------	-------------------------	---------------------------	-----------

STANLEY HYDRAULIC

MODELS: CS05, CS06

13" (33.02cm)	56	.325" NK	.050" (1,3mm)	25056NKTL		L2501356-11095TL		
15" (38.10cm)	64	.325" NK	.050" (1,3mm)	25064NKTL		L2501564-11095TL		
15" (38.10cm)	64	.325"	.058" (1,5mm)	25864TL		L2581564-11095TL	R2581564-11095TL	H2581564-11095TL
16" (40.64cm)	59	3/8"	.050" (1,3mm)	35059TL		L3501659-11095TL		
16" (40.64cm)	66	.325" NK	.050" (1,3mm)	25066NKTL		L2501666-11095TL		
16" (40.64cm)	66	.325"	.058" (1,5mm)	25866TL		L2581666-11095TL	R2581666-11095TL	H2581666-11095TL
18" (45.72cm)	64	3/8"	.050" (1,3mm)	35064TL		L3501864-11095TL		
18" (45.72cm)	72	.325" NK	.050" (1,3mm)	25072NKTL		L2501872-11095TL		
18" (45.72cm)	72	.325"	.058" (1,5mm)	25872TL		L2581872-11095TL	R2581872-11095TL	
20" (50.80cm)	78	.325"	.050" (1,3mm)	25078TL		L2502078-11095TL		
20" (50.80cm)	78	.325"	.058" (1,5mm)	25878TL		L2582078-11095TL	R2582078-11095TL	H2582078-11095TL

STIHL

MODELS: POLE PRUNERS: HT 70, HT 73, HT 75, HT 100, HT 101, HT 130, HT 131, HT 250

12" (30.48cm)	44	3/8"LP NK	.043" (1,1mm)	14344TL	M1431244-1074TL			
14" (35.56cm)	50	3/8"LP NK	.043" (1,1mm)	14350TL	M1431450-1074TL			

MODELS: 009, 009L, 010, 011, 012, 015, 017, 018, 018C, 019, 019T, 020, 020 SUPER, 020T, 021, 023, 023C, 023L, E 10, E 14, E 140, MS 170, MS 171, E 180, E 180C, MS 180 C, MS 180 C-B, MS 180 C-BE, MS 181, MS 181C-BE, MS 190T, MS 191T, MS 192C, MS 192 T, MS 192TC, MS 200, MS 200 T, MS 210 C, MS 201T, MS 210, MS 210 C, MS 210 C-BE, MS 211, MS 211C, MS 211 C-BE, MS 220, MS 220 Q, MS 230, MS 230 C, MS 230 C-BE, MS 250, MS 250 C, MS 250, C-BE, MS 140, MS 140 C, MS 140 C-BQ, MSE 180, MSE 180 C, MSE 180 C-BQ, MSE 200

12" (30.48cm)	44	3/8"LP NK	.043" (1,1mm)	14344TL	M1431244-1074TL			
12" (30.48cm)	44	3/8"LP	.050" (1,3mm)	15044TL	M1501244-1074TL			
14" (35.56cm)	50	3/8"LP NK	.043" (1,1mm)	14350TL	M1431450-1074TL			
14" (35.56cm)	50	3/8"LP	.050" (1,3mm)	15050TL	M1501450-1074TL			
16" (40.64cm)	55	3/8"LP	.050" (1,3mm)	15055TL	M1501655-1074TL			

MODELS: 021, 025, 025C, MS 230, MS 230C, MS 230C-BE, MS 250, MS 250C, MS 250C-BE

16" (40.64cm)	62	.325" NK	.050" (1,3mm)	25062NKTL		L2501662-1074TL		
16" (40.64cm)	62	.325"	.050" (1,3mm)	25062TL		L2501662-1074TL		
16" (40.64cm)	62	.325"	.058" (1,5mm)	25862TL		L2581662-1074TL		

MODELS: 024, 024 SUPER, 026, 026P, 026 PRO, 028, 028 SUPER, 029, 030, 031, 032, 034, 034 SUPER, 036, 036P, 036 QS, 039, FARM BOSS, MS 260, MS 260 PRO, MS 261, MS 261 C-Q, MS 270, MS 270 C-B, MS 270, MS 270 C-B, MS 270 C, MS 270 C-QS, MS 271, MS 280, MS 280 C-BQ, MS 280 C-QS, MS 290, MS 291, MS 291 BEQ, MS 360, MS 360 C, MS 360 PRO, MS 360 Q-S

15" (38.10cm)	62	.325"	.063" (1,6mm)	36362TL		L2631562-4025TL		
16" (40.64cm)	67	.325"	.050" (1,3mm)	35067TL		L2501667-4025TL		
16" (40.64cm)	67	.325"	.063" (1,6mm)	36367TL		L2631667-4025TL	R2631667-4025TL	
18" (45.72cm)	74	.325"	.050" (1,3mm)	35074TL		L2501874-4025TL		
18" (45.72cm)	74	.325"	.063" (1,6mm)	36374TL		L2631874-4025TL	R2631874-4025TL	H2631874-4025TL
20" (50.80cm)	81	.325"	.050" (1,3mm)	35081TL		L2502081-4025TL		
20" (50.80cm)	81	.325"	.063" (1,6mm)	36381TL		L2632081-4025TL	R2632081-4025TL	H2632081-4025TL

MODELS: 029, 030, 031, 032, 034, 036, 036P, 036 PRO, 036QS, 040, MS 290, MS 291, MS 291C-BEQ, MS 310, MS 311, MS 360, MS 360 C, MS 360 PRO, MS 360 QS, MS 361, MS 361C-B, MS 361 C-Q, MS 362, MS 362 C-Q, MS 390, MS 391, 034 SUPER, E 15, E 20, E 220 Q, MS 260, MS 260 PRO, MSE 220, MSE 220 Q

16" (40.64cm)	60	3/8"	.050" (1,3mm)	35060TL		L3501660-4025TL		
18" (45.72cm)	66	3/8"	.050" (1,3mm)	35066TL		L3501866-4025TL		
20" (50.80cm)	72	3/8"	.050" (1,3mm)	35072TL		L3502072-4025TL		

STIHL continued on page 67

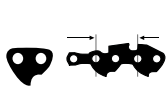

CUTTING LENGTH	DRIVE LINKS	PITCH	GAUGE	CHAIN PART NUMBER	MINI LAMINATE	LAMINATED SPROCKET NOSE	REPLACEABLE SPROCKET NOSE	HARD NOSE
----------------	-------------	-------	-------	-------------------	---------------	-------------------------	---------------------------	-----------

STIHL (cont.)

MODELS: 038, 038 SUPER MAGNUM, 039, 041, 042, 044, 044M, 045, 046, 046M, 048, 056, 056S, 064, 066, 066 MAGNUM, MS 440, MS 440 MAGNUM, MS 441, MS 441C, MS 460, MS 460 MAGNUM, MS 650, MS 660, MS 660M

16" (40.64cm)	60	3/8"	.050" (1,3mm)	35060TL		L3501660-4025TL		
16" (40.64cm)	60	3/8"	.063" (1,6mm)	36360TL		L3631660-4025TL	R3631660-4025TL	H3631660-4025TL
18" (45.72cm)	66	3/8"	.050" (1,3mm)	35066TL		L3501866-4025TL		
18" (45.72cm)	66	3/8"	.063" (1,6mm)	36366TL		L3631866-4025TL	R3631866-4025TL	H3631866-4025TL
20" (50.80cm)	72	3/8"	.050" (1,3mm)	35072TL		L3502072-4025TL		
20" (50.80cm)	72	3/8"	.063" (1,6mm)	36372TL		L3632072-4025TL	R3632072-4025TL	H3632072-4025TL
22" (55.88cm)	76	3/8"	.063" (1,6mm)	36376TL			R3632276-4025TL	H3632276-4025TL
24" (60.96cm)	84	3/8"	.063" (1,6mm)	36384TL			R3632484-4025TL	H3632484-4025TL
28" (71.12cm)	92	3/8"	.063" (1,6mm)	36392TL			R3632892-4025TL	H3632892-4025TL
30" (76.20cm)	98	3/8"	.063" (1,6mm)	36398TL			R3633098-4025TL	H3633098-4025TL
36" (91.44cm)	114	3/8"	.063" (1,6mm)	363114TL			R36336114-4025TL	H36336114-4025TL

MODELS: 050, 051, 075, 076, 07S, 084, 088, 088M, 08SEQ, E 30, MS 880, MS 880 MAGNUM, S 10

21" (53.34cm)	68	.404"	.063" (1,6mm)	46368TL			R4632168-5031TL	H4632168-5031TL
25" (63.50cm)	80	.404"	.063" (1,6mm)	46380TL			R4632580-5031TL	H4632580-5031TL
30" (76.20cm)	92	.404"	.063" (1,6mm)	46392TL			R4633092-5031TL	H4633092-5031TL

TANAKA

MODELS: PRUNER MODELS: TPS-200, TPS210, TPS-250, TPS-250PF, TPS-270, TPS-270PF, TPS-2501, TPS-2510

10" (25.40cm)	40	3/8"LP NK	.043" (1,1mm)	14340TL	M1431040-1041TL			
12" (30.48cm)	45	3/8"LP NK	.043" (1,1mm)	14345TL	M1431245-1041TL			

MODELS: ECS-35, ECS-290, ECS-300, ECS-320, ECS-330, ECS-350, ECS-351, ECS-355, ECS-356, ECS-370, ECS-405, ECS-3301, ECS-3351, ECS-3401, ECS-3500, TCS-33EB, TCS-3301PFS, ECS-3351PFS, TCS-3401

12" (30.48cm)	45	3/8"LP NK	.043" (1,1mm)	14345TL	M1431245-1041TL			
12" (30.48cm)	45	3/8"LP	.050" (1,3mm)	15045TL	M1501245-1041TL	L1501245-1041TL		
14" (35.56cm)	52	3/8"LP NK	.043" (1,1mm)	14352TL	M1431452-1041TL			
14" (35.56cm)	52	3/8"LP	.050" (1,3mm)	15052TL	M1501452-1041TL	L1501452-1041TL		
16" (40.64cm)	57	3/8"LP NK	.043" (1,1mm)	14357TL	M1431657-1041TL			
16" (40.64cm)	57	3/8"LP	.050" (1,3mm)	15057TL	M1501657-1041TL	L1501657-1041TL		
18" (40.64cm)	62	3/8"LP	.050" (1,3mm)	15062TL	M1501862-1041TL	L1501862-1041TL		

MODELS: ECS-415, ECS-4000, ECS-4000B, ECV-4501, TCS40EA

15" (38.10cm)	64	.325" NK	.050" (1,3mm)	25064NKTL		L2501564-11041TL		
16" (40.64cm)	66	.325" NK	.050" (1,3mm)	25066NKTL		L2501666-11041TL		
16" (40.64cm)	66	.325"	.050" (1,3mm)	25066TL		L2501666-11041TL		
18" (45.72cm)	72	.325" NK	.050" (1,3mm)	25072NKTL		L2501872-11041TL		
20" (50.80cm)	78	.325"	.050" (1,3mm)	25078TL		L2502078-11041TL		

MODELS: ECV-5601

16" (40.64cm)	66	.325" NK	.050" (1,3mm)	25066NKTL		L2501666-11095TL		
16" (40.64cm)	66	.325"	.050" (1,3mm)	25066TL		L2501666-11095TL		
18" (45.72cm)	72	.325" NK	.050" (1,3mm)	25072NKTL		L2501872-11095TL		
18" (45.72cm)	72	.325"	.050" (1,3mm)	25072TL		L2501872-11095TL		

MODELS: ECS-505, ECS-506, ECS-650, ECS-655

16" (40.64cm)	60	3/8"	.050" (1,3mm)	35060TL		L3501660-4176TL		
18" (45.72cm)	64	3/8"	.050" (1,3mm)	35064TL		L3501864-4176TL		
18" (45.72cm)	66	3/8"	.050" (1,3mm)	35066TL		L3501866-4176TL		
20" (50.80cm)	70	3/8"	.050" (1,3mm)	35070TL		L3502070-4176TL		



GUIDE BAR MOUNTS

The TriLink® guide bar mount section of this catalog gives you a quick reference guide. Using a physical guide bar you can match the guide bar mount to the mount silhouettes, which are shown at full scale, by simply laying them directly on the page to confirm the correct mount.

1041

BAR TYPES: CARVING,
MINI LAMINATE, LAMINATE, HARD NOSE

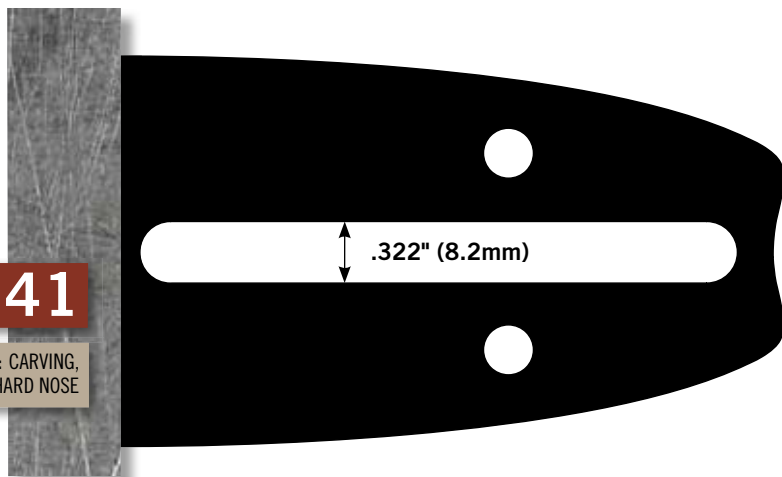

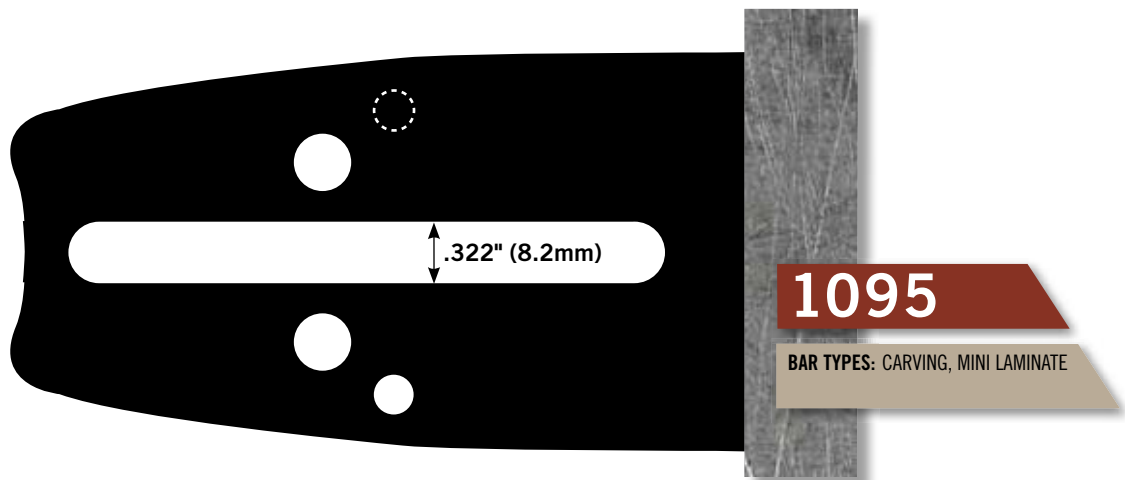
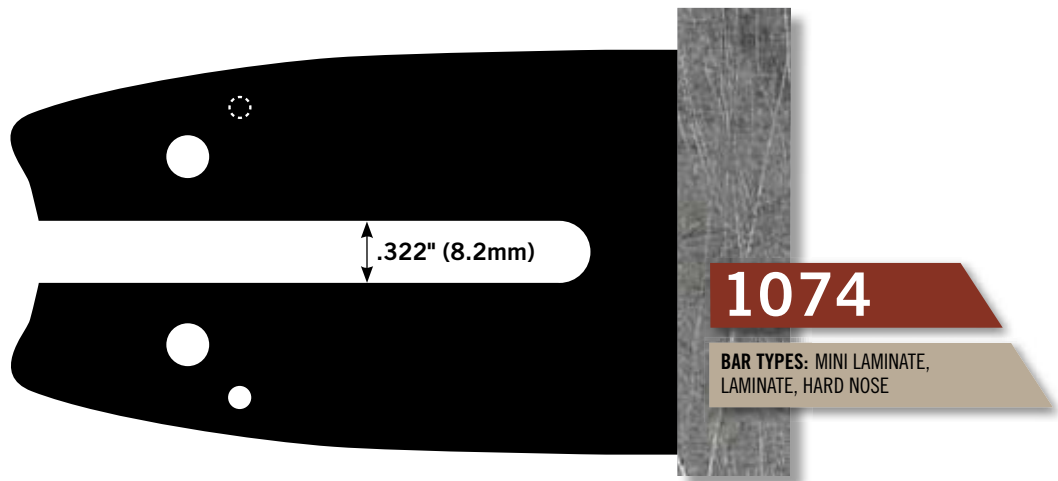

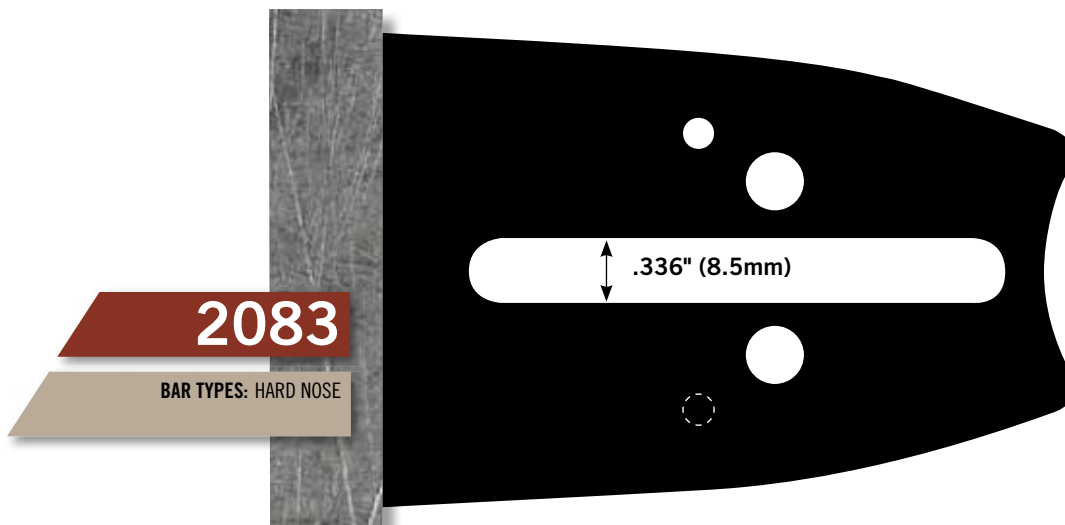
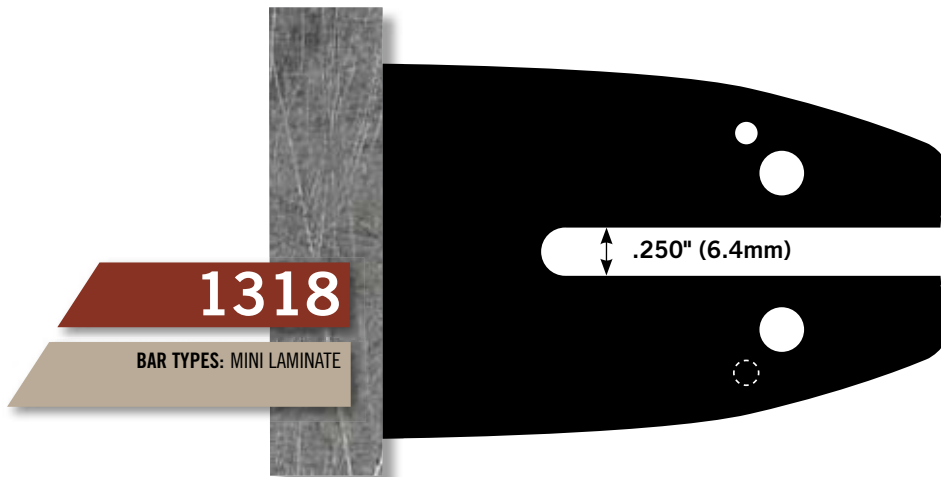
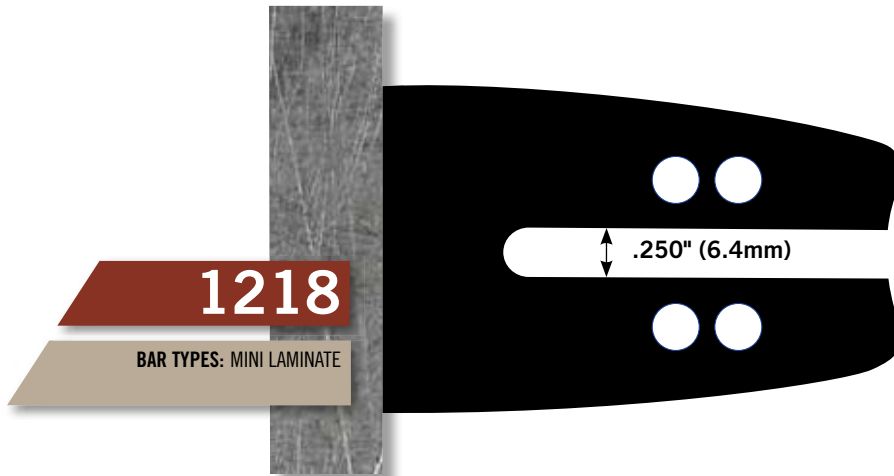

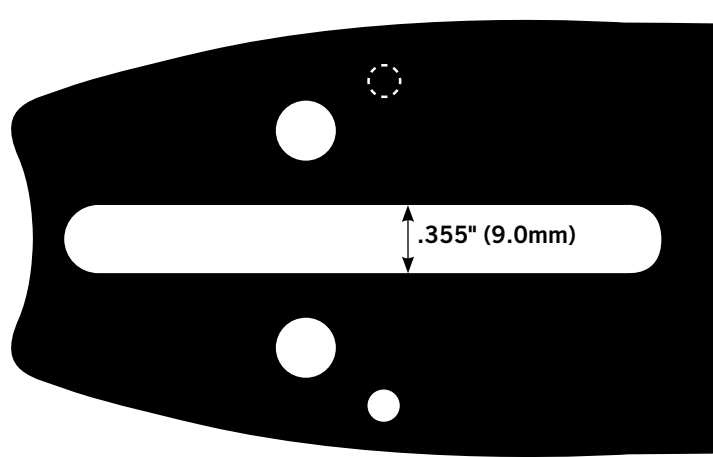

4009

BAR TYPES: LAMINATE, RSN,
HARD NOSE

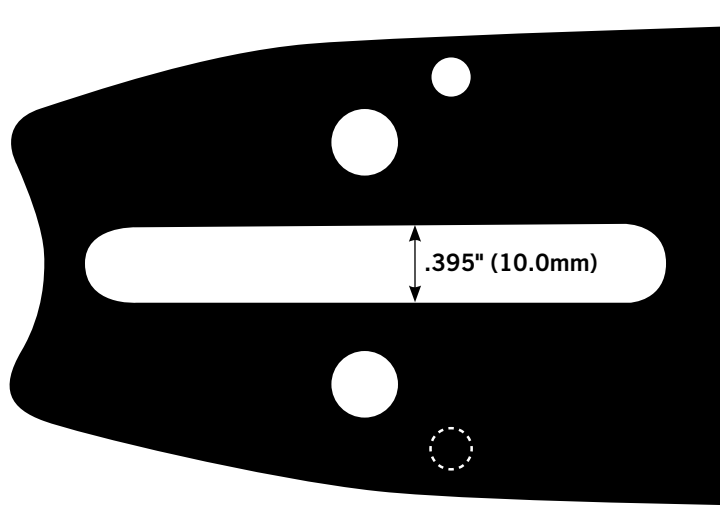

4024

BAR TYPES: HARD NOSE

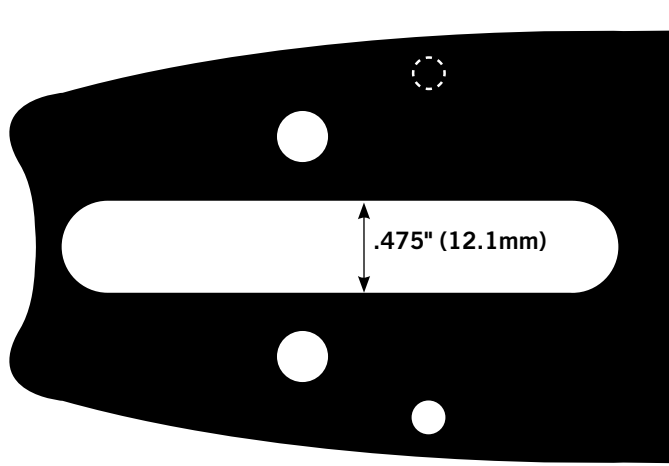

4025

BAR TYPES: LAMINATE, RSN,
HARD NOSE

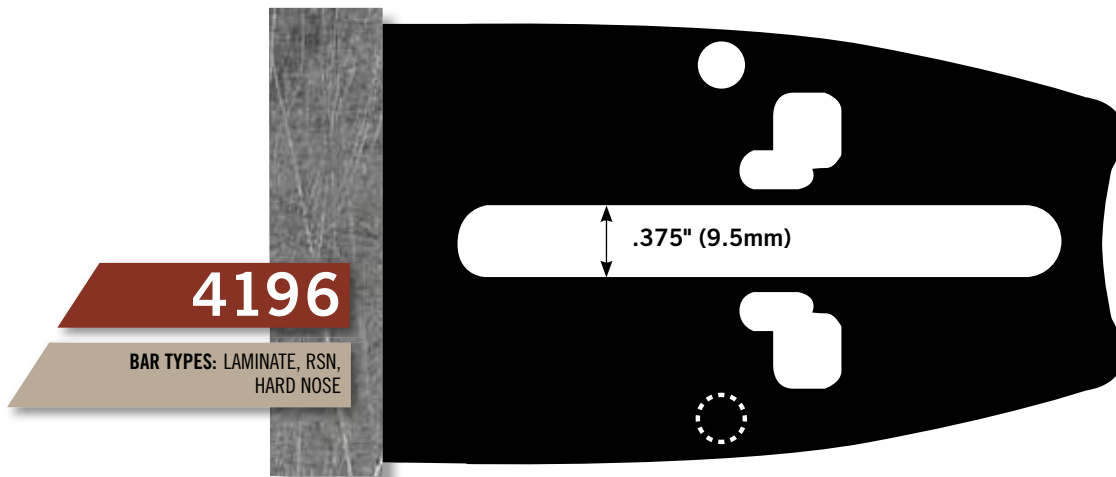
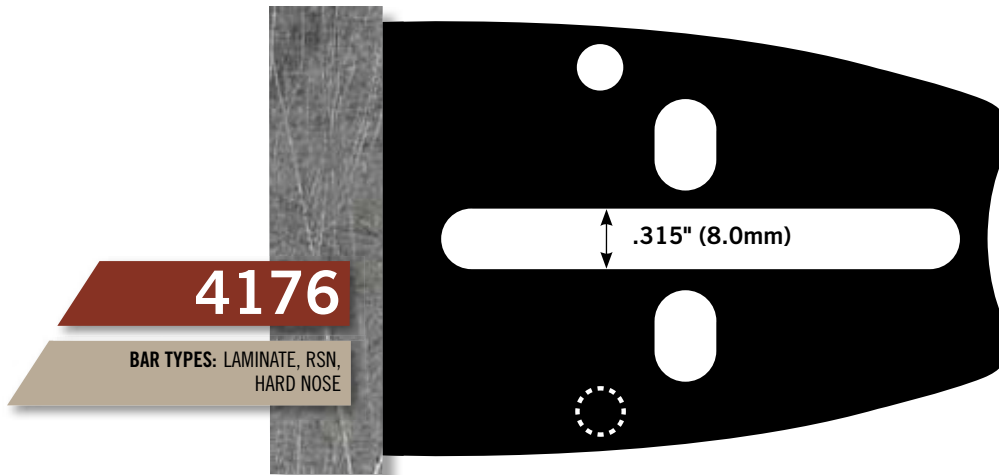

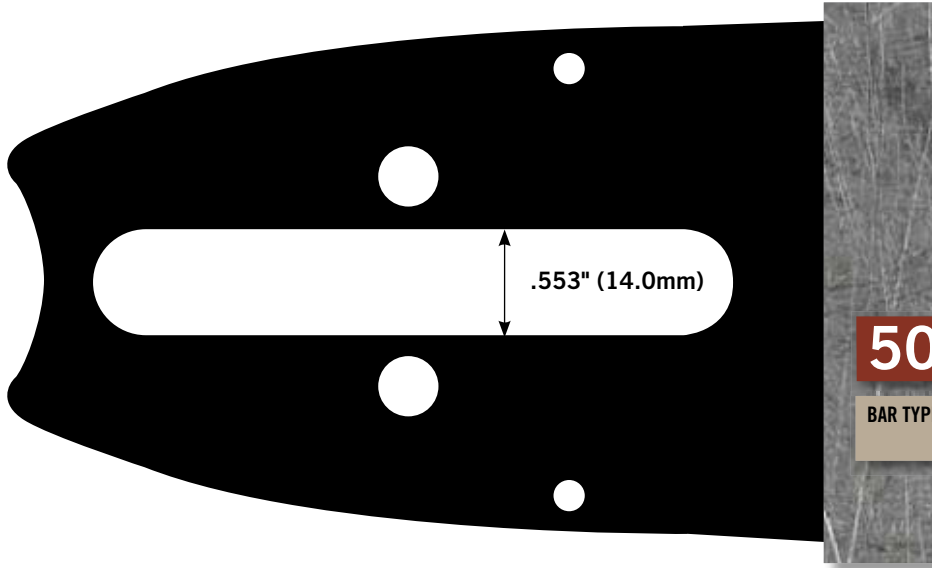

5031

BAR TYPES: RSN, HARD NOSE

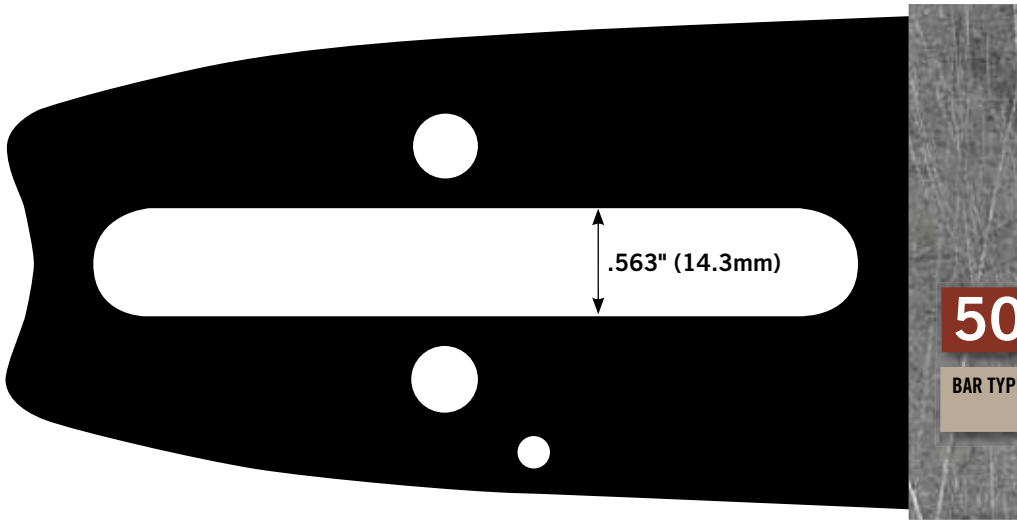

5033

BAR TYPES: HARD NOSE

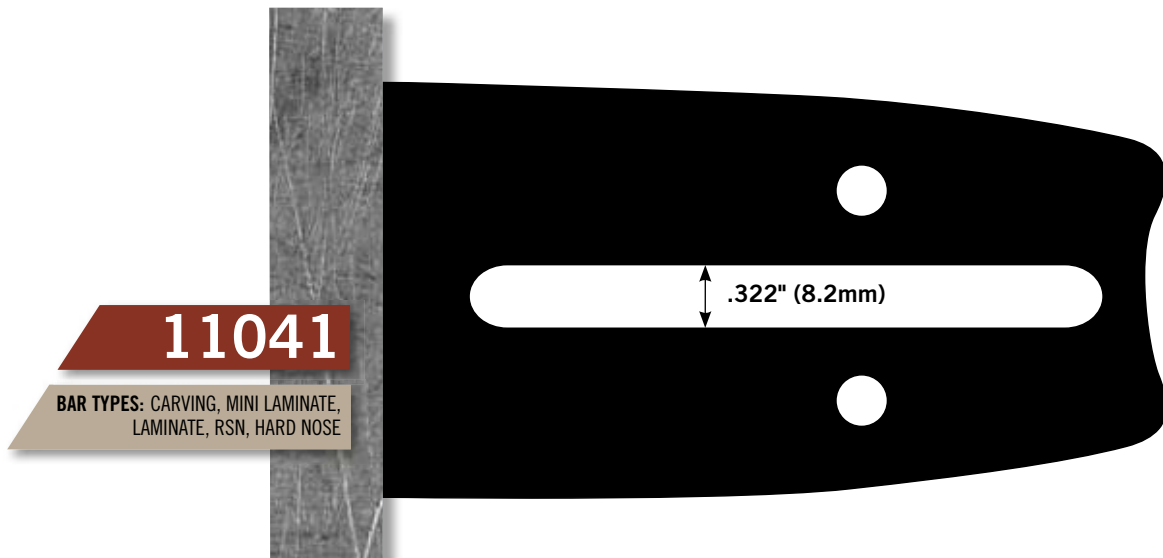
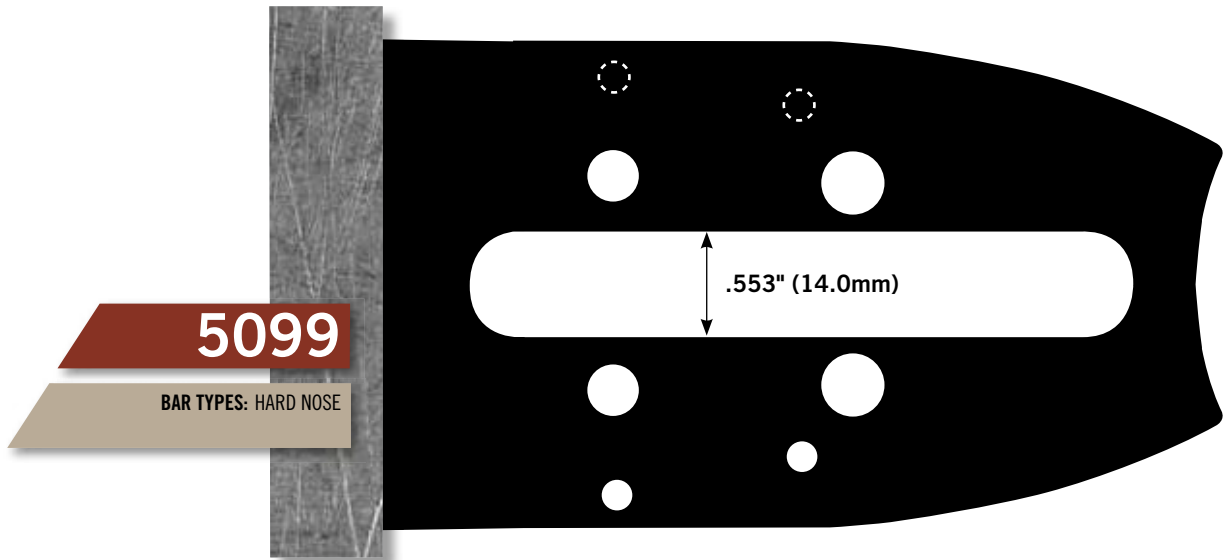

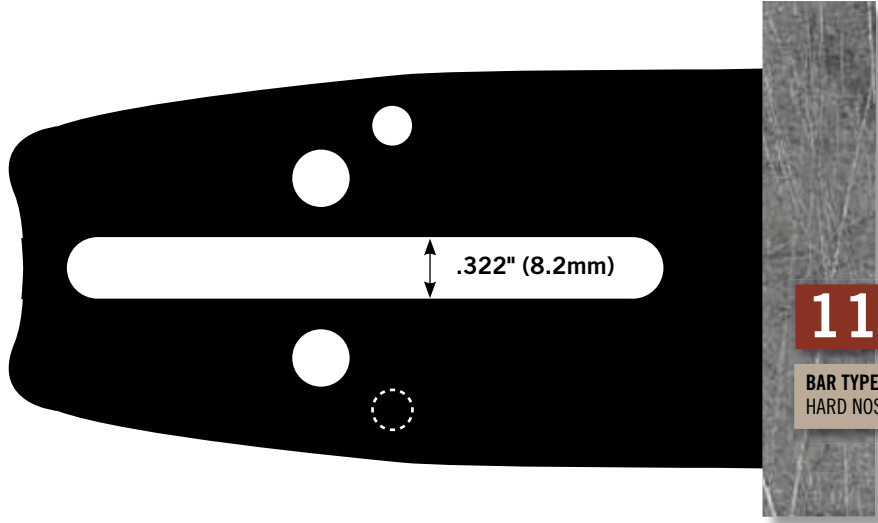

11095

BAR TYPES: LAMINATE, RSN,
HARD NOSE

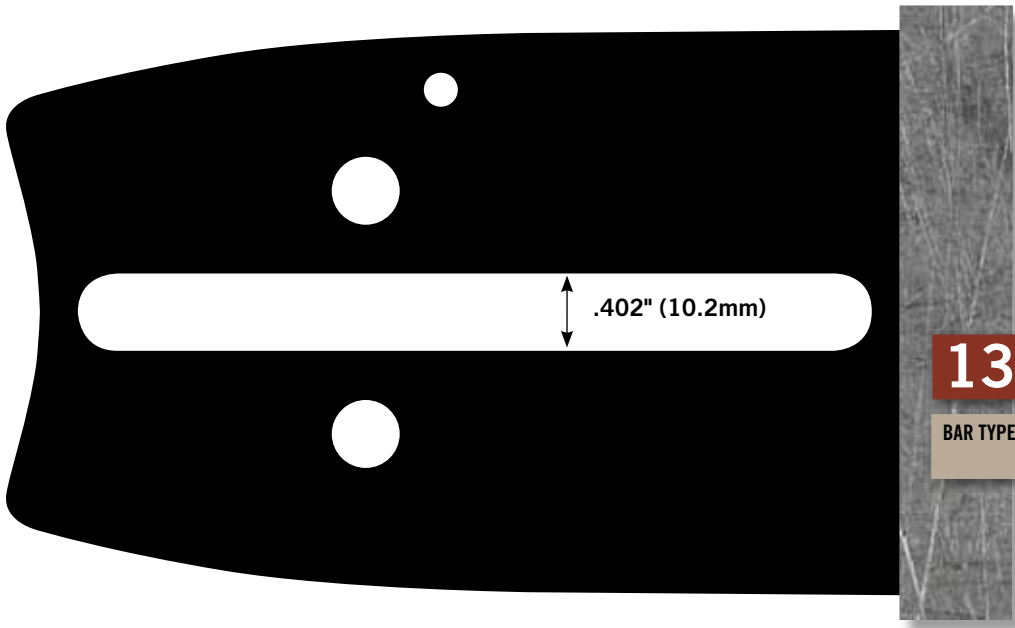

13015

BAR TYPES: LAMINATE, RSN,

CUTTING ACCESSORIES

The safest chain is a sharp chain. TriLink® saw chain offers a complete range of cutting accessories, maintenance tools, and safety equipment to fit all of your saw chain needs and keep your chain saw running smooth.



8 PIECE SHARPENING FIELD KIT

TRILINK PART NO.	DESCRIPTION / PACKAGING
------------------	-------------------------

FK001TL | 8 Piece Sharpening Field Kit - Clamshell Packaging

- Includes: flat file, depth gauge, filing guide with thumbscrew, 5/32" round file, 3/16" round file, 7/32" round file, wood handle, and a durable field carry case (available in multiple colors)
- Precision spiral cut round files provides clean, fast sharpening without scoring the cutter surfaces
- A complete set of tools for all your saw chain filing needs





DEPTH GAUGE AND FLAT FILE

TRILINK PART NO.	DESCRIPTION / PACKAGING
------------------	-------------------------

DGFF001TL	Depth Gauge & Flat File - Blister Card Packaging
FF001TL	Flat Files - Bulk - 12 Per Box

- A complete filing system for resetting depth gauges after sharpening to optimize chain performance
- Universal and versatile tool that can be used with all manufacturer's chain saws
- Solid steel construction for durability

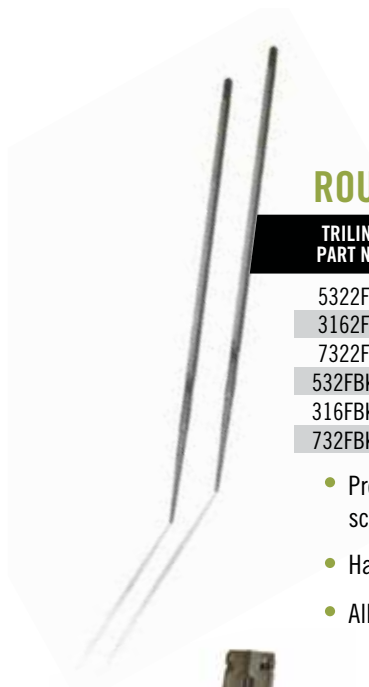

ROUND FILES

TRILINK PART NO.	DESCRIPTION / PACKAGING
------------------	-------------------------

5322FTL	5/32" [4.0mm] Files - Retail - 2 Per Package
3162FTL	3/16" [4.8mm] Files - Retail - 2 Per Package
7322FTL	7/32" [5.5mm] Files - Retail - 2 Per Package
532FBKTL	5/32" [4.0mm] Files - Bulk - 12 Per Box
316FBKTL	3/16" [4.8mm] Files - Bulk - 12 Per Box
732FBKTL	7/32" [5.5mm] Files - Bulk - 12 Per Box

- Precision spiral cut design provides clean, fast sharpening without scoring the cutter surfaces
- Hardened carbon steel construction for longer tool life
- All sizes available in twin pack or bulk pack



ROUND FILE AND GUIDE

TRILINK PART NO.	DESCRIPTION / PACKAGING
------------------	-------------------------

532FNGTL	5/32" [4.0mm] File & Guide - Wood Handle - Blister Card Packaging
316FNGTL	3/16" [4.8mm] File & Guide - Wood Handle - Blister Card Packaging
732FNGTL	7/32" [5.5mm] File & Guide - Wood Handle - Blister Card Packaging

- Precision spiral cut design provides clean, fast sharpening without scoring the cutter surfaces
- Chromed file guide enables the user to sharpen the chain at the correct angle for optimum cutting performance
- Thumbscrew enables the user to securely mount the file to the guide without movement during use



110V / 220V ELECTRIC SHARPENER

TRILINK PART NO.	DESCRIPTION / PACKAGING
------------------	-------------------------

ECS120ACTL	110V AC Electric Sharpener - Clamshell or Box Packaging
------------	---

- Available in both 110 and 220 volt applications
- 30,000 RPM AC powered motor for quick easy sharpening
- Includes 72" heavy duty power cord and chain angle guide and one of each size sharpening stone: 5/32", 3/16" and 7/32"
- Rust-resistant construction provides long-lasting durability



12V ELECTRIC SHARPENER

TRILINK PART NO.	DESCRIPTION / PACKAGING
------------------	-------------------------

ECS12DCTL	12V DC Electric Sharpener - Clamshell or Box Packaging
-----------	--

- 25,000 RPM DC powered motor for quick easy sharpening
- Includes heavy duty power battery connection cable and chain angle guide and one of each size sharpening stone: 5/32", 3/16" and 7/32"
- Rust-resistant construction provides long-lasting durability



REPLACEMENT STONES

TRILINK PART NO.	DESCRIPTION / PACKAGING
------------------	-------------------------

532SSTL	5/32" [4.0mm] Replacement Stones - Blister Card Packaging - 3 per pack
316SSTL	3/16" [4.8mm] Replacement Stones - Blister Card Packaging - 3 per pack
732SSTL	7/32" [5.5mm] Replacement Stones - Blister Card Packaging - 3 per pack

- Designed for use with TriLink brand chain saw sharpeners but will also fit PowerCare, CountyLine, Craftsman, Oregon, and Dremmel brands
- For use with both AC and DC electric sharpeners
- Used to sharpen both gas and electric saws



GREASE GUN

TRILINK
PART NO.

DESCRIPTION / PACKAGING

LG001TL | Bar Lubrication Gun - Blister Card Packaging

- A well-oiled bar nose enables the chain to run smoothly around the bar nose with low friction thereby reducing heat and chain stretch
- Compatible for all chain saws that have a sprocket nose guide bar, regardless of length or brand of chain saw
- High impact plastic body with steel nose and heavy duty spring
- Light weight and durable for ease of use in the field and for many years of use
- Reloadable cartridge easily refilled with all-purpose grease for many years of use without having to replace the tool



SCRENCH

TRILINK
PART NO.

DESCRIPTION / PACKAGING

TS-1319TL | 13mm x 19mm Wrench-Screwdriver Combo - Blister Card Packaging

- Enables quick and easy field adjustments to keep your chain saw running at peak performance
- 13mm and 19mm deep socket wrench for spark plugs and quick removal of bar nuts to replace guide bar or chain
- Flat head screwdriver for adjusting chain tension
- Compatible with most major manufacturers' chain saws
- Additional sizes available



FELLING WEDGE

TRILINK
PART NO.

DESCRIPTION / PACKAGING

FW001TL | Poly Felling Wedge - Blister Card Packaging

- Designed for use in preventing pinching of the chain saw guide bar and chain
- Used for aiding in directional felling of trees and bucking
- Made of heavy duty plastic material for durability
- 5-1/2" rasp length



FILING VISE

TRILINK
PART NO.

DESCRIPTION / PACKAGING

FV001TL | Logger Filing Vise - Clamshell or Box Packaging

- Hardened steel construction for longer tool life
- Forked ends firmly drive into tree stumps for easy field use
- Adjustable screw for secure grip of chain saw guide bar



CHAIN BREAKER

TRILINK
PART NO.

DESCRIPTION / PACKAGING

BK001TL | Saw Chain Breaker - Box Packaging

SBK001TL | Saw Chain Breaker and Rivet Spinner Combo Pack - Box Packaging

- Hardened steel construction for longer tool life
- Punch sizes for all saw chain sizes 3/8" LP, .325", 3/8", and .404"
- Mounts to benches for easy rivet breaking



RIVET SPINNER

TRILINK
PART NO.

DESCRIPTION / PACKAGING

SP001TL | Saw Chain Rivet Spinner - Box Packaging

SBK001TL | Saw Chain Breaker and Rivet Spinner Combo Pack - Box Packaging

- Hardened steel construction for longer tool life
- Produces strong and secure rivets for all saw chain sizes 3/8" LP, .325", 3/8", and .404"
- Mounts to benches for easy rivet breaking



BAR MOUNT SHARPENER

TRILINK
PART NO.

DESCRIPTION / PACKAGING

BMS2000TL | Bar Mount Sharpener - Clamshell Packaging

- Manually sharpens all major saw chain pitches: 3/8" LP, .325", 3/8", and .404"
- Precise settings allow for matching manufacturer's saw chain angles
- Firmly and easily attaches to all guide bars
- Accurately lowers depth gauges and supports both triangle and flat depth gauge files



SAFETY GLOVES

TRILINK
PART NO.

DESCRIPTION / PACKAGING

GV001TL | Chain saw Safety Gloves - Hang Tag Packaging

- Equipped with ballistic nylon on back of left hand for protection from chain saw kickback
- Breathable padded spandex with PVC secure grip patches located on inner palms
- Elastic velcro for snug fit
- One size fits most



EAR MUFFS

TRILINK
PART NO.

DESCRIPTION / PACKAGING

EM001TL | Branded Ear Muff Set - Clamshell Packaging

- Comfortable, adjustable foam ear cushions for optimum noise protection
- Noise reduction rating of 20 decibels
- Foldable and compact for easy storage
- One size fits most



SAFETY HELMET

TRILINK
PART NO.

DESCRIPTION / PACKAGING

PSH001TL | Safety Helmet, Ear muffs, and Face Shield - Box Packaging

- An adjustable ratchet-style harness for a comfortable fit
- Wide sealing ear muffs provide superior sound protection
- Meets ANSI/OSHA standards
- CE certified worldwide



BRANDED SAFETY HELMET

TRILINK
PART NO.

DESCRIPTION / PACKAGING

SM967 | Safety Helmet, Ear muffs, and Face Shield - Box Packaging

- An adjustable ratchet-style harness for a comfortable fit
- Wide sealing ear muffs provide superior sound protection
- Meets ANSI/OSHA standards
- CE certified worldwide



VISOR FACE SHIELD AND EAR MUFFS

TRILINK
PART NO.

DESCRIPTION / PACKAGING

JE206+JF502 | Mesh Visor Face Shield & Ear Muffs - Box Packaging

- An adjustable ratchet-style harness for a comfortable fit
- Wide sealing ear muffs provide superior sound protection
- Meets ANSI/OSHA standards

RIM SPROCKETS

TriLink[®] replacement rim sprockets are high quality cast to provide long wear life and excellent performance for the professional user. The rim rides on the hub splines allowing for the chain to be perfectly aligned with the bar groove. The rim sprocket takes the majority of the wear thereby reducing wear to the center drive sprocket. This reduces down time and cost of repair to the drive system.

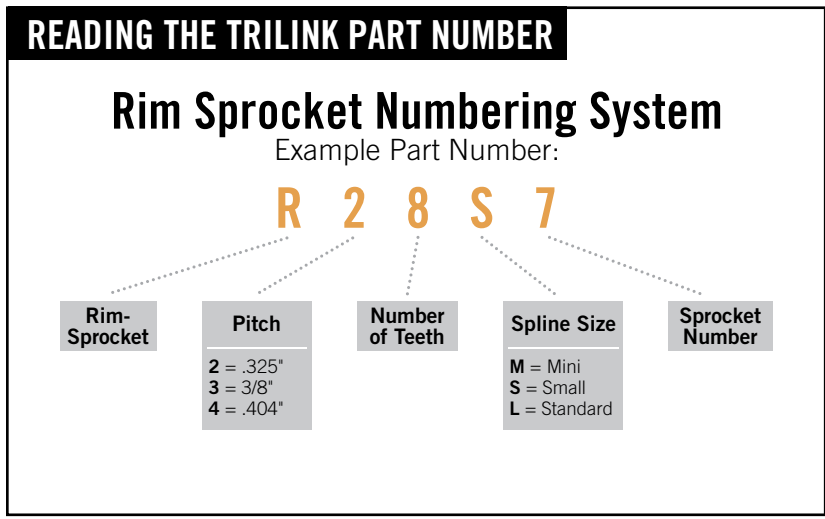

I.D.: 0.775"

O.D.: 1.460"

PITCH: .325"

R28S7

GB PART NUMBER: GBJ8S7

DESCRIPTION: **8 Tooth - Small - 7 Spline**

I.D.: 0.775"

O.D.: 1.265"

PITCH: .325"

R27S7

GB PART NUMBER: GBJ7S7

DESCRIPTION: **7 Tooth - Small - 7 Spline**

I.D.: 0.665"

O.D.: 1.257"

PITCH: .325"

R27M7

GB PART NUMBER: GBJ7M7

DESCRIPTION: **7 Tooth - Mini - 7 Spline**

I.D.: 0.886"

O.D.: 1.640"

PITCH: .325"

R29L7

GB PART NUMBER: GBJ9L7

DESCRIPTION: **9 Tooth - Standard - 7 Spline**

I.D.: 0.886"

O.D.: 1.405"

PITCH: 3/8"

R37L7

GB PART NUMBER: GBA7L7

DESCRIPTION: **7 Tooth - Standard - 7 Spline**



R38L7

GB PART NUMBER: GBA8L7

DESCRIPTION: **8 Tooth - Standard - 7 Spline**

PITCH: 3/8"

O.D.: 1.603"

I.D.: 0.892"



R37S7

GB PART NUMBER: GBA7S7

DESCRIPTION: **7 Tooth - Small - 7 Spline**

PITCH: 3/8"

O.D.: 1.406"

I.D.: 0.775"



R37M7

GB PART NUMBER: GBA7M7

DESCRIPTION: **7 Tooth - Mini - 7 Spline**

PITCH: 3/8"

O.D.: 1.395"

I.D.: 0.652"



R47L7

GB PART NUMBER: GBB7M7

DESCRIPTION: **7 Tooth - Standard - 7 Spline**

PITCH: .404"

O.D.: 1.513"

I.D.: 0.870"



R48L7

GB PART NUMBER: GBB8L7

DESCRIPTION: **8 Tooth - Standard - 7 Spline**

PITCH: .404"

O.D.: 1.765"

I.D.: 0.886"



CENTER DRIVE SPROCKETS

TriLink® center drive sprockets are solid one-piece construction. Center drive sprockets work in unison with the rim sprockets. The center drive sprocket system allows the user to change out the rim sprocket, due to wear and tear, instead of changing out the entire system. Additionally this allows the user to easily change the saws chain pitch.

READING THE TRILINK PART NUMBER

Center Drive Sprocket Numbering System
Example Part Number:

C ST 328 L 1 7 N

Center Drive Sprocket	Make	Sprocket Number	Spline Size	Pitch	Number of Teeth
	HO = Homelite MC = McCulloch PO = Poulan HU = Husqvarna EC = Echo ST = Stihl PA = Partner		M = Mini S = Small L = Standard	1 = 3/8" LP 2 = .325" 3 = 3/8" 4 = .404"	O = Bushing N = Bearing X = No Bushing or Bearing



CST328-L37N

GB PART NUMBER: GB/ST328-LCA7N

FITS:

STIHL: 064, 066

PITCH: 3/8"

7 SPLINE



CHU400-L37N

GB PART NUMBER: GB/HU400-LCA7N

FITS:

HUSQVARNA: 162, 222, 266, 268, 272, 61, 66, Rancher 61

PITCH: 3/8"

7 SPLINE



CPA475-S27N

GB PART NUMBER: GB/PA475-SCJ7N

FITS:

PARTNER: 350, 365, 405

PITCH: .325"

7 SPLINE



CST305-S27N

GB PART NUMBER: GB/ST305-SCJ7N

FITS:

STIHL: 017, 018, 021, 023, 025, MS170, MS180, MS210, MS230, MS250, MS019, MS350C, MS190

PITCH: .325"

7 SPLINE



SPUR SPROCKETS

TriLink® spur sprockets are a machine produced, solid steel construction. Produced to exact OEM specifications our spur sprockets incorporate both the clutch drum and the drive sprocket into a single piece. Sprockets are as important to your chain saw as the engine and the saw chain.

Our spur sprockets are available in inner packs of 10 and cases of 50.

READING THE TRILINK PART NUMBER

Spur Sprocket Numbering System
Example Part Number:

S HO 110 1 6 N

Spur Sprocket	Make	Sprocket Number	Pitch	Number of Teeth	0 = Bushing N = Bearing X = No Bushing or Bearing
	HO = Homelite MC = McCulloch PO = Poulan HU = Husqvarna EC = Echo ST = Stihl PA = Partner		1 = 3/8" LP 2 = .325" 3 = 3/8" 4 = .404"		



SHO110-16N

PITCH: 3/8" LP

6 TOOTH

GB PART NUMBER: GB/HO110-R6N
OREGON PART NUMBER: 38010

FITS:

HOMELITE: 245, XL1, Mini EZ, EZ, 101, Super EZ200, 150 AUTO, Super EZ 240



SHO113-37N

PITCH: 3/8"

7 TOOTH

GB PART NUMBER: GB/HO113-A7N
OREGON PART NUMBER: 30666X and 30681X

FITS:

HOMELITE: XL-12 (After Serial #1735838), SuperXL, XLAO, XL400, XL500, XL800, SXL952, VI944, VI955, 450, 550, 923



SHO100-16N

PITCH: 3/8" LP

6 TOOTH

GB PART NUMBER: GB/HO100-R6N
OREGON PART NUMBER: 27958

FITS:

HOMELITE: XLMINI, SLX Mini AO, 190, 200, XL-101XL, XL2, 180, Super 2, 192, VI Super 2



SMC443-37N

PITCH: 3/8"

7 TOOTH

GB PART NUMBER: GB/MC443-A7N
OREGON PART NUMBER: 32786X

FITS:

McCULLOCH: PM-55, PM-60, SP-60, CP-60, CP-70, 1-10, 2-10, Mac3-10, Mac4-10, Mac5-10, Mac6-10, Mac7-10, 10-10, 610, 650, PM750, PM655, PM700, PM800, 850, CP-80, SP81, SP81E



SMC446-16N

PITCH: 3/8" LP

6 TOOTH

GB PART NUMBER: GB/MC446-R6N
OREGON PART NUMBER: 29888

FITS:

McCULLOCH: MM-3AS, MAC6, PM6A, SuperPro 40, 3200, 365, All Mini Mac's, Titan 35-40, ProMac 3205, 2000-2016, 2316, 2318, 3000, 3210-3216, Mac 110-140, Power Mac 310-340, PM 480, 120, Eager Beaver

6 TOOTH

PITCH: 3/8" LP

SPO529-16NGB PART NUMBER: GB/PO529-R6N
OREGON PART NUMBER: 28004

FITS:

DOLMAR: 101**POULAN:** 20, Micro 25, 1800, Micro S25, 180, 205, 225, 235, 2000,
2100, 2300, 2400

7 TOOTH

PITCH: 3/8"

SPO531-37XGB PART NUMBER: GB/PO531-A7X
OREGON PART NUMBER: 32790X

FITS:

POULAN: 375, 395, 3400, 3800, 4000, 3700

7 TOOTH

PITCH: .325"

SHU414-27NGB PART NUMBER: GB/HU414-J7N
OREGON PART NUMBER: 108308X

FITS:

HUSQVARNA: 350, 351, 345, 340, 346XP

7 TOOTH

PITCH: .325"

SPO527-27NGB PART NUMBER: GB/PO527-J7N
OREGON PART NUMBER: 107504X

FITS:

POULAN: 285, 305, 355, 336, 2800, 3000, 3300

7 TOOTH

PITCH: .325"

SEC206-27NGB PART NUMBER: GB/EC206-J7N
OREGON PART NUMBER: 37509

FITS:

ECHO: 3900, CS4100, 3600, 4510K, CS4400, CS3700, CS400,
CS4200, CS4400, CS4500



SST316-37N

PITCH: 3/8"

7 TOOTH

GB PART NUMBER: GB/ST316-A7N
OREGON PART NUMBER: 38145X

FITS:

STIHL: 034, 036, 029, 039, MS310, MS290, MS360, MS390



SEC208-37N

PITCH: 3/8"

7 TOOTH

GB PART NUMBER: GB/EC208-A7N
OREGON PART NUMBER: 21358X

FITS:

ECHO: CS451, CS451VL, 550, CS500, CS452, Farma, CS510, CS600 EVL
TWN, 610, CS650, CS660



SST315-27N

PITCH: .325"

7 TOOTH

GB PART NUMBER: GB/ST315-J7N

FITS:

STIHL: 028



SH0121-16N

PITCH: 3/8" LP

6 TOOTH

GB PART NUMBER: GB/HO121-R6N
OREGON PART NUMBER: 108567

FITS:

HOMELITE: 3300, 3350, 3800, 3850, 3014, 23, 25, 3816, 3850, 4450,
PS33, Timberman, UT10926, UT10901, i3850b, i4150b, i4550b



SPA 475-27N

PITCH: .325"

7 TOOTH

GB PART NUMBER: GB/PA475-J7N
OREGON PART NUMBER: 41726X

FITS:

PARTNER: 365, 405, 350

6 TOOTH

PITCH: 3/8" LP

SPA475-16NGB PART NUMBER: GB/PA475-R6N
OREGON PART NUMBER: 41569X

FITS:

PARTNER: 365, 405

6 TOOTH

PITCH: 3/8" LP

SPO532-16NGB PART NUMBER: GB/PO532-R6N
OREGON PART NUMBER: 106114

FITS:

POULAN: 230, 260, 2050, 2075, 2150, 2175, 2250,
2155, 2375, 2450, Wildthing, Woodshark

6 TOOTH

PITCH: 3/8" LP

SEC202-16NGB PART NUMBER: GB/EC202-R6N
OREGON PART NUMBER: 106906X

FITS:

ECHO: 3000, 3400, 3500, 3450, CS300, CS305, CS340,
CS341, CS345, CS446

7 TOOTH

PITCH: .325"

SST305-27NGB PART NUMBER: GB/SST305-J7N
OREGON PART NUMBER: 106657X

FITS:

STIHL: 021, 023, 025, 017, 018, 019, MS210, MS250, MS170, MS180

7 TOOTH

PITCH: .325"

SST316-27NGB PART NUMBER: GB/ST316-J7N
OREGON PART NUMBER: 38145X

FITS:

STIHL: 029, 034, 036, 039, MS290, MS310, MS360, MS390



SST305-16N

PITCH: 3/8" LP

6 TOOTH

GB PART NUMBER: GB/ST305-R6N
OREGON PART NUMBER: 100962X

FITS:

STIHL: 021, 023, 025, 017, 018, MS210, MS250, MS170, MS180



SHU400-37N

PITCH: 3/8"

7 TOOTH

GB PART NUMBER: GB/HU400-A7N
OREGON PART NUMBER: 32071

FITS:

HUSQVARNA: 61 (After SN 0510572), 266 (After SN 0510000),
368 (After SN 0510000), 272 (After SN 0510000)

JONSERED: 625 (After SN 0510123), 630 (After SN 0510000), 630 Super
(After SN 0510000), 630 West Coast (After SN 0510000), 670 (After SN 0510153)



SST311-37N

PITCH: 3/8"

7 TOOTH

GB PART NUMBER: GB/ST311-A7N
OREGON PART NUMBER: 32061X

FITS:

STIHL: 038, 038 Super Magnum



SST322-47N

PITCH: .404"

7 TOOTH

FITS:

STIHL: 070

www.trilinksawchain.com

TriLink Saw Chain LLC

101 Marietta Street Suite 2425
Atlanta, GA 30303
sawchainsales@trilinkglobal.com
1.877.492.9829

TriLink Saw Chain Sales

130 Corridor Road # 661
Ponte Vedra Beach, FL 32082
dwedow@trilinkglobal.com
1.904.285.0687

TriLink Saw Chain Engineering

P.O. Box 68204
Portland, OR 97268
1.404.985.1672

TriLink Latin America Sales

Avenida General Las Heras 1845
C.P. 11.600
Montevideo Uruguay
ricardod@trilinkglobal.com
p. 598.2487.5593
c. 598.9377.0774