



**RM1**  
**(ALBR1372-11)**



Use & Care Instructions

## TABLE OF CONTENTS

1. Welcome to iio .....	page 2	7. Energy saving tips .....	page 13
2. Product overview .....	page 3	8. Cleaning .....	page 14
3. Important safety notes .....	page 4	9. Troubleshooting .....	page 16
4. Installation .....	page 6	10. Warranty .....	page 17
5. Product dimensions .....	page 8	11. Your appliance information .....	page 18
6. Operation .....	page 10		

## WELCOME TO iio!

*Congratulations and thank you for your purchase!* We truly appreciate your business and are grateful for the trust you have placed in us and our products.

You have purchased one of the most efficient refrigeration products available today. We are proud of this beautifully designed refrigerator and believe it will bring you years of reliable service.

At iio, we design our appliances for both space and energy efficiency. Our mission is to create a range of stylish home appliances that fit your life, your style, space parameters, taste, eco aspirations, functional needs, budget and way of shopping. We want to help turn any space where you live, into a home.

Please register your refrigerator at [www.iioKitchen.com](http://www.iioKitchen.com).

For any inquiries, please contact us at: 1-833-446-4461 or visit [www.iioKitchen.com](http://www.iioKitchen.com) for additional information regarding your appliance.

### **Extend your warranty today!**

- Receive up to 1 month of extended warranty for submitting a photo and 2 months of extended warranty by submitting a video (pending review).

### **To be considered for approval:**

- Photo upload must demonstrate the product's use or application in a natural setting, and should clearly show the product from a perspective not already shown on the site.
- Video review must be at least 30 seconds in duration, clearly show the product in use in a natural setting, and include insightful product-specific audio commentary.
- The photo or video must be of sufficient quality, in the opinion of the iio™ management, that it can be used on our website and in other promotional materials.
- Submitting the photo and video represents your permission that we may have unlimited use of these materials wherever we require, at no additional cost.

## PRODUCT OVERVIEW

- The images in this guide may differ from the actual components and accessories, which are subject to change without prior notice for product improvement purposes.

**Note: The appearance of components of the appliance may differ from model to model.**

- The refrigerator is intended for storing fresh food at temperatures above 32° F (0° C).
- Appliance temperature may be changed by adjusting the control panel settings.
- The freezer section is intended for freezing fresh and already frozen food and for long-term storage. Length of storage time is dependent on the type of food being stored.

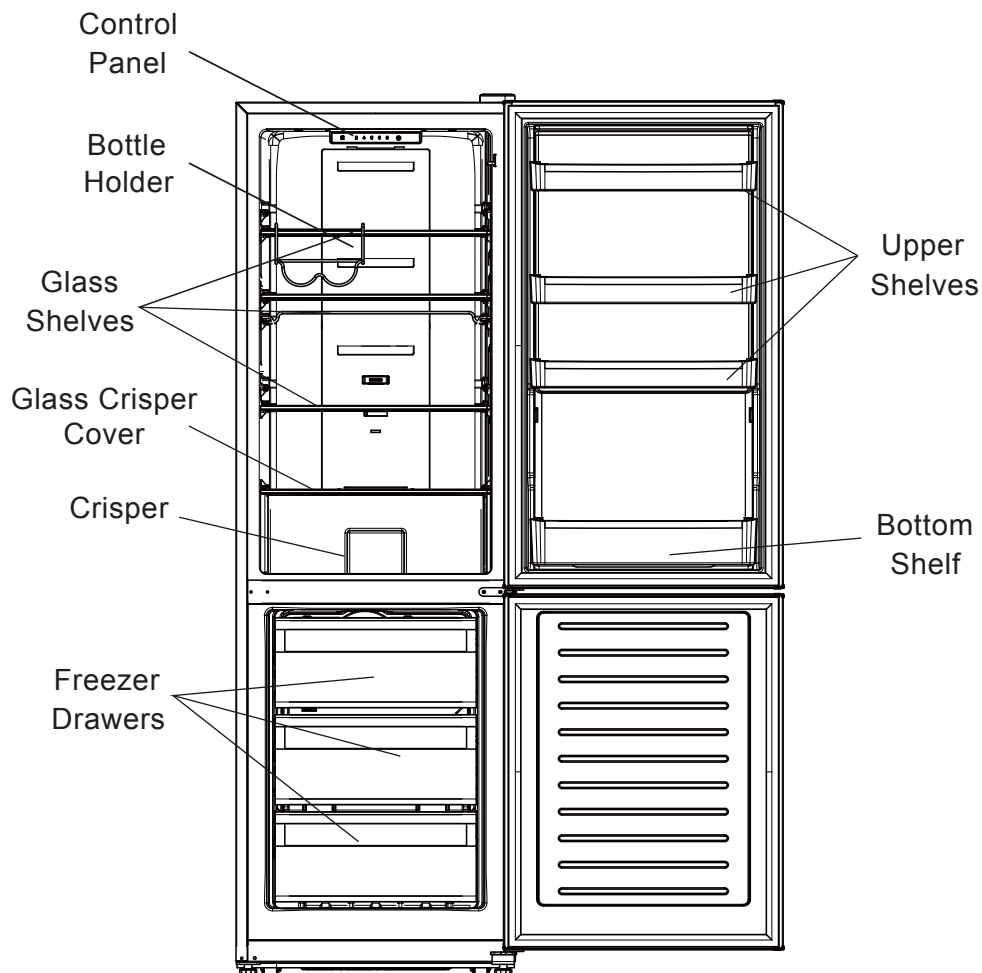

## IMPORTANT SAFETY NOTES

Always read and follow all safety messages.

### READ ALL INSTRUCTIONS BEFORE USE.



**Alert Symbol** – will display **WARNING** or **CAUTION** beside the instruction. Messages with the Alert Symbol will inform you of the potential hazard, provide guidance for reducing the hazard, and inform of the possible outcome if the instruction is not followed.

**WARNING – YOU MAY BE KILLED, SERIOUSLY INJURED OR DAMAGE THE APPLIANCE IF THE INSTRUCTION IS NOT FOLLOWED.**

**CAUTION – YOU MAY BE INJURED OR DAMAGE THE APPLIANCE IF THE INSTRUCTION IS NOT FOLLOWED.**



### WARNING

- Flammable refrigerant used. To be repaired by trained service personnel only. Do not puncture refrigerant tubing or other parts that use refrigerant. Consult user manual before attempting any repairs. All safety precautions must be followed.
- When using this appliance follow basic precautions to reduce the risk of electrical shock, explosion, fire, serious injury or death.
- Do not put flammable, explosive, volatile and highly corrosive items in the appliance to prevent damage to the appliance and prevent injury or death. Keep materials and vapors, such as gasoline and alcohol, away from appliance.
- Use non-flammable cleaner to clean the appliance.
- Do not use electrical appliances (i.e. hair dryer or fan) inside the appliance compartments.
- Disconnect the power before servicing or cleaning.



- This appliance is not intended to be used by children under the age of 8.
- Children shall not play with the appliance. Do not allow any child to get into, climb the appliance or play with the appliance doors.
- Do not allow children to play in, on or around the fridge. It is not a toy. THERE IS A DANGER OF SUFFOCATION IF A CHILD BECOMES TRAPPED INSIDE.
- When the appliance is not in use, secure or remove the doors to prevent children from playing inside the cabinets.
- Risk of child entrapment. Before throwing away an old appliance remove the door(s), remove the shelves to prevent children from climbing inside.
- This appliance is not intended for use by persons (including children) whose physical, sensory or mental capabilities may be different or reduced, or who lack experience or knowledge, unless such persons receive supervision or training to operate the appliance by a person responsible for their safety.
- Cleaning and user maintenance shall not be made by children without supervision.



### CAUTION

- Appliance **MUST** be in a vertical position for 24 hours before being connected to power.
- Replace all appliance parts and panels before operation.
- To avoid injury two or more people are required to move and install the appliance.

### Prop. 65 Warning for California Residents



**WARNING:** This product may contain chemicals known to the State of California to cause cancer, birth defects, or other reproductive harm.



**Dispose of properly in accordance with federal and/or local regulations. In case of punctured tubing follow all handling instructions carefully.**

# INSTALLATION



## WARNING

- When using this appliance follow basic precautions to reduce the risk of electrical shock, explosion, fire, serious injury or death.
- Only connect this product to a dedicated grounded electrical outlet rated for use with this product (110-125V, 1.0A, 60Hz, AC only). It is the user's responsibility to replace a standard 2-prong wall outlet with a standard 3-prong (grounded) wall outlet. Ensure that the grounding electrode is equipped with a reliable grounding line.
- Do not damage the refrigerant circuit.
- Never attempt to operate this appliance if it is damaged, malfunctioning, partially disassembled, or has missing or broken parts, including a damaged cord or plug.
- Do not remove the ground prong from the power cord.
- Do not use an extension cord.
- Do not use an adapter on the wall socket.
- Do not pull out plug using the power cord. Firmly grasp the plug and pull it out from the socket.
- When moving the appliance, be careful not to roll, bend, pinch or damage the power cord.
- Do not install the appliance in a damp or dusty place where insulation or electrical parts may deteriorate.
- Do not place electrical appliances on top of the appliance.
- Keep packing materials out of the reach of children. Packaging material can be dangerous for children as there is a risk of suffocation.
- Do not place the appliance in direct sunlight or expose it to the heat from heating appliances such as stoves or heaters.
- Do not place heavy objects on top of the appliance as they may fall and cause injury when the appliance door is opened.
- Do not use sharp instruments, rubbing alcohol, flammable fluids, or abrasive cleaners to remove tape or glue. These products can damage the surface of your appliance.



## CAUTION

- Do not use an outlet that can be turned off with a switch.
- Appliance **MUST** be in a vertical position for 24 hours before being connected to the power outlet.
- Install the appliance in a dry and well ventilated room. Ambient temperature should be between 18 °C ~ 38 °C (64 °F ~ 100 °F).
- To avoid injury or damage to the appliance, installation should be carried out by two people.
- The appliance is heavy. Protect the floor when moving the appliance for cleaning or servicing.
- Always pull the appliance straight out when moving it. Do not wiggle or walk the appliance as floor damage could occur.
- Keep ventilation openings clear of obstructions.
- Never pick up or move the refrigerator by the door.





### Remove the Packaging

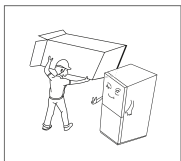

- Remove tape and any temporary labels from your refrigerator before use. Do not remove any warning labels, the model and serial number labels, or the circuit diagram from the appliance as this will void the warranty.
- Carefully remove the protective plastic film on the doors and refrigerator body.
- If required, carefully use tweezers or other small instruments to start the peeling at the corners.

### Appliance Location

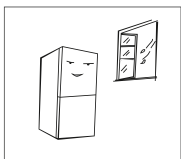
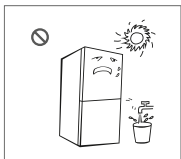

- To avoid noise and vibration, the appliance must be installed and leveled on a solidly constructed floor. If required, adjust the leveling legs to compensate for the unevenness of the floor.
- Keep away from heat and avoid direct sunlight.
- Do not place the appliance in humid or watery places to prevent corrosion or reduced insulation efficiency.
- Ensure that the appliance is placed in a well-ventilated indoor location.
- Ensure that there is enough space around the appliance, as indicated in diagram (pg. 8), to allow for proper ventilation.

**Note:** Installation on carpeting, soft tile surfaces, a platform or weakly supported structure is not recommended. Surface shall be flat and sturdy (rotate left and right to adjust the wheel for levelling if unsteady).

## PRODUCT DIMENSIONS

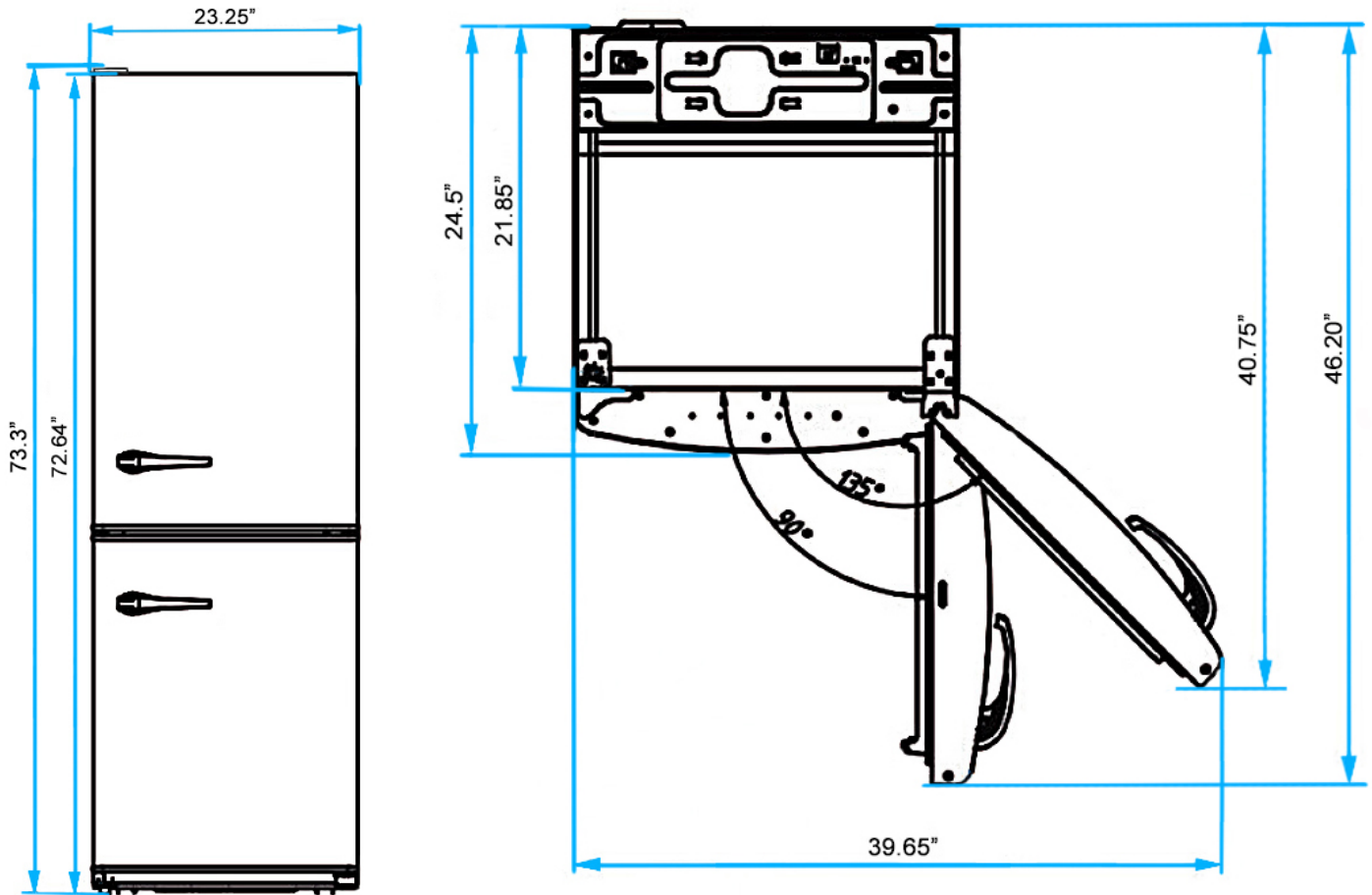

- Your refrigerator should be installed on a flat and even floor. Keep the refrigerator level by adjusting the front leg levers.



## Dimensions and Clearances

- Check the dimensions of the appliance and the installation path to ensure there is sufficient room to move the appliance through doors or narrow openings.
- The installation location chosen for the appliance should allow space behind the unit for connections and airflow as well as space in front to open the doors.
- Too small of a distance from adjacent items may result in reduced cooling and freezing capability and increased power consumption. Allow at least 29 1/8" inches (740 mm) in front of the appliance to open the doors, and at least 2 inches (50 mm) between the back of the appliance and the wall.

## Levelling

- The refrigerator has two front leveling legs. Adjust the legs to alter the tilt from front-to back or side-to side. If the refrigerator seems unsteady, or the doors do not close easily, adjust the refrigerator's tilt using the instructions below:
  1. Turn the leveling leg counterclockwise to raise that side of the refrigerator or clockwise to lower it. It may take several turns of the leveling leg to adjust the height of the appliance.
  2. Open the door and check to make sure that it closes easily. If the door does not close easily, tilt the refrigerator slightly more to the rear by turning both leveling legs counterclockwise. It may take several more turns.

## Positioning the Refrigerator

- Arrange the refrigerator so that it does not vibrate against adjoining surfaces or against the wall. Be sure to maintain a 2" clearance between the back of the appliance, sides and wall.

# OPERATION

## Before Use



### CAUTION

- Do not scratch the appliance with a sharp object or use a detergent that contains alcohol, a flammable liquid or an abrasive when removing any tape or adhesive from the appliance.

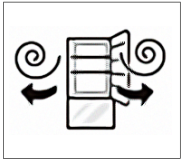

- Do not peel off the model or serial number label or the wiring diagram on the rear surface of the appliance as this will void the warranty.
- Open appliance doors to ventilate the interior as the appliance may have a "new car smell".
- Clean the appliance thoroughly by wiping off all surfaces with a soft cloth and mild detergent.



- The appliance may make a loud noise after initial operation. This is normal and will decrease as the temperature decreases.
- Remove any adhesive tape from inside the appliance and open the doors for ventilation.

## Control Panel Display

Depending on the model, some of the following functions may not be available. The control panel display may differ from model to model.

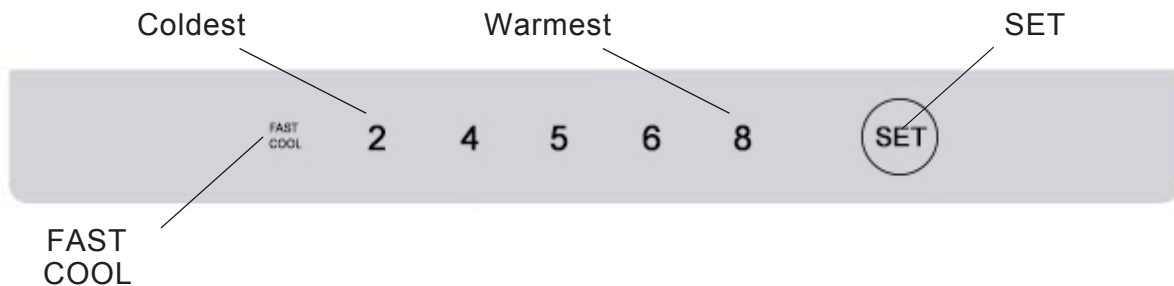

- The control panel regulates the appliance temperature. There are five (5) settings to choose from. The lowest number (2) provides the coldest temperature, the highest number (8) provides the warmest temperature.
- The default temperature setting is 5.
- Cycle through the different temperature settings by pressing and releasing the SET button until the desired setting has been reached.
- As you cycle through the different temperature settings the illuminated number for each setting will flash several times and will stop flashing once it has been set.

## FAST COOL

- FAST COOL Function - operates the appliance at maximum cooling for 30 hours. This feature can be used after placing a large quantity of food in the fridge.
- To activate the FAST COOL function press and release the SET button to cycle through the settings until the FAST COOL setting is illuminated. FAST COOL will flash and then stop flashing once it sets.
- To exit the FAST COOL setting press the SET button.
- After 30 hours FAST COOL mode will revert to the previous setting if it is not exited by the user.

## Open Door Alarm (Refrigerator Door Only)



- An audible alarm will sound if the appliance door is kept open for more than 3 minutes. Close the door to deactivate the alarm. If the door is kept open for more than 10 minutes the interior lighting will turn off.

## Bottle Holder Feature

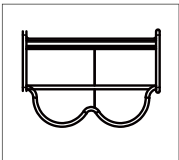

- The bottle holder is used to hold bottles and cans and can be positioned on the glass shelves.

## Glass Shelves

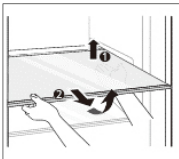

- Glass shelves can be positioned to the desired height by the user.
- To reposition a shelf, place one hand in the back of the shelf and one at the front of the shelf. Gently lift the back of the shelf and carefully pull the shelf out towards you.
- Tilt the front of the shelf up about 60° and completely pull out the shelf.
- Gently re-install the shelf at the desired position by reversing these steps.
- Ensure that the shelf is gently pushed towards the back of the refrigerator and that the tabs on either side of the shelf are properly seated in their slots located at the back of the refrigerator.



### CAUTION

Exercise care when moving shelves, drawers, and door shelves to avoid breakage.

## Crisper

- The crisper is typically used to hold vegetables and fruit.
- Preferably, place the items in a sealed bag or container to maintain the proper humidity levels.

## Door Shelves

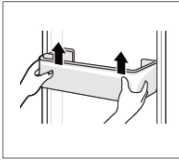

- The upper and lower door shelves are used to hold smaller items such as drinks, eggs, cheese, etc.
- The third upper shelf can be adjusted higher to allow taller containers to be placed in the bottom shelf. Gently lift up the third upper shelf and re-install it in the holding slot above.
- All of the four door shelves can be removed for cleaning. Gently lift up the shelf using both hands placed on both ends of the shelf. Lift both sides the same amount to avoid jamming or causing damage to the shelf or refrigerator panel.
- Re-install the shelf ensuring that it is lowered evenly and horizontally. Tap the shelf gently to ensure it is properly seated.

## Freezer Drawers

- Freezer drawers are used for storing frozen food and for freezing fresh food.

## Ice Cube Tray

- The ice cube tray may be placed in a freezer drawer for making ice.

## Defrosting the Refrigerator

- This appliance is frost free but occasionally a buildup of frost may occur. This is dependent on a variety of reasons such as frequent opening of the door or seasonal changes.
- If defrosting is required disconnect the appliance from the power supply and gently wipe down surfaces with a dry cloth and place a towel in the appliance to collect any excess water.

## ENERGY SAVINGS TIPS

- Do not install the fridge close to sources of heat, such as a stove, boiler, heater, chimney, etc, and avoid exposure of the appliance to direct sunlight.
- Locate the appliance in a cool well-ventilated room and make sure that the air vents of the compressor housing cover are not obstructed. Also allow adequate spacing around the cabinet for air circulation (2").
- Avoid unnecessary frosting in the cabinet by packing all food and liquids in airtight packages or containers.
- Always keep food stored in tightly sealed packaging or containers, and allow some space for air to circulate around each item.
- Avoid keeping the door open for extended periods of time or opening the door too frequently as warm air will enter the cabinet and cause the compressor to run unnecessarily.
- Ensure there are no obstructions preventing the doors from closing properly and forming a tight seal.
- To ensure a safe food storage temperature, maintain an operating temperature inside the fridge cabinet of 2°C/36°F to 4°C/39°F. Fridge temperatures warmer than 4°C/39°F can promote unsafe bacterial growth in food.

# CLEANING



## WARNING

- Unplug the appliance from the power source before cleaning.
- Do not use large amounts of water or liquid when cleaning the appliance as this may affect electrical components and insulating properties of the appliance.



## CAUTION

- Do not use any detergents or flammable substances such as alcohol, thinner, bleach, or other flammable liquids to clean the appliance.
- Cleaning solutions that contain abrasives, acids or solvents are not suitable for cleaning and may damage the fridge and cause discoloration. Do not use these types of cleaners.
- Do not use sharp objects when cleaning the appliance as these may scratch the appliance.
- Do not peel off or damage the model or serial number labels on the surfaces of the appliance as this will void the warranty.
- Regular cleaning of the appliance is recommended to prevent odors and ensure efficient operation of the unit. This includes interior surfaces such as interior walls, shelves, and door shelves as well as exterior components such as door gaskets, handles, sides, and the condenser unit.
- Use a soft damp cloth with mild detergent to clean all surfaces.
- Removable parts such as shelves, drawers and door shelves may be taken out for cleaning.
- Wipe up spills immediately.
- Surfaces should be dried after being wiped.



## CAUTION

Exercise care when moving shelves, drawers, and door shelves to avoid breakage.

## Freezer Drawers

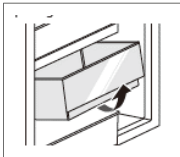

- Freezer drawers can be pulled out for cleaning.
- Hold the handle of the drawer and gently pull it out until it stops.
- Tilt the drawer upwards about 30° up to be able to remove it completely.
- Gently reinstall the drawer by reversing these steps.

## Exterior Cleaning

- Check and clean the door gasket regularly to ensure that there is no debris on it.
- Exterior surfaces of the appliance can also be cleaned with a soft damp cloth with mild detergent.
- Periodically clean the dust that accumulates under and behind the appliance to improve the cooling efficiency.

## Compressor Cavity



### WARNING

- Turn off the appliance and unplug the appliance from the power source before attempting to clean the compressor cavity.
- Take extreme care when cleaning this section of the appliance as it contains electrical and mechanical components as well as delicate refrigerant tubes that must not be damaged.

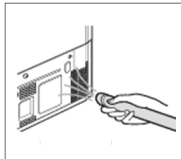

- Check and clean the door gasket regularly to ensure that there is no debris on it.
- Exterior surfaces of the appliance can also be cleaned with a soft damp cloth with mild detergent.
- Periodically clean the dust that accumulates under and behind the appliance to improve the cooling efficiency.



## TROUBLESHOOTING

PROBLEM	POSSIBLE CAUSE OR REMEDY
<b>Appliance is connected but does not work:</b>	<ul style="list-style-type: none"> <li>• Ensure that the appliance is plugged in and there is power in the outlet.</li> <li>• Confirm that circuit breaker or fuse has not tripped.</li> </ul>
<b>Cooling system operates continuously for extended periods of time:</b>	<ul style="list-style-type: none"> <li>• Ambient temperature too high.</li> <li>• Door opened frequently or for too long.</li> <li>• Door not closed properly (misaligned, damaged or dirty door seals).</li> <li>• Large load of food added at once.</li> <li>• Temperature sensor blocked by food, preventing proper air circulation.</li> <li>• Ensure recommended clearances are adhered to.</li> <li>• Ensure there is adequate air circulation behind the appliance.</li> </ul>
<b>Excessive ice build up on the back wall:</b> (Note: some moisture buildup is normal)	<ul style="list-style-type: none"> <li>• Temperature setting is too cold.</li> <li>• Door not shut properly or opened excessively.</li> <li>• Recently added a large quantity of warm food to the cabinet.</li> <li>• Close proximity to heat source or direct sunlight.</li> <li>• Ambient temperature or humidity is very high.</li> </ul>
<b>Ice or frost build up in the freezer:</b>	<ul style="list-style-type: none"> <li>• Door opened too frequently or for too long.</li> <li>• Door not closed properly.</li> <li>• Poor door sealing.</li> <li>• Door seal damaged or dirty, replace or clean seal.</li> <li>• Extremely humid environment.</li> </ul>
<b>Door will not close:</b>	<ul style="list-style-type: none"> <li>• Check and clean the door gasket regularly to ensure that there is no debris on it.</li> </ul>
<b>Door difficult to open:</b>	<ul style="list-style-type: none"> <li>• Clean door gaskets and contact surfaces with mild soap and warm water.</li> </ul>
<b>LED lighting does not work:</b>	<ul style="list-style-type: none"> <li>• Call a service technician. Do not attempt to repair this yourself as there is danger of making contact with high voltage.</li> </ul>

For other troubleshooting inquiries or for an iio™ authorized repair center please contact us at: 1-833-446-4461 or email us a [service@iiookitchen.com](mailto:service@iiookitchen.com).

## WARRANTY

iio™ warrants all refrigerators will be free from defects in materials or workmanship for a period of TWO YEARS from the date of original purchase.

THERE ARE NO OTHER WARRANTIES, EXPRESSED OR IMPLIED, INCLUDING BUT NOT LIMITED TO, WARRANTIES OR MERCHANTABILITY OR FITNESS FOR A PARTICULAR PURPOSE. Proof of purchase/original invoice may be required to claim warranty. Keep a photocopy easily accessible.

If the home in which the refrigerator is installed is sold within the warranty period, the new owner is protected until the expiration of the original purchaser's warranty. During this two-year period, iio™ will at its option, repair or replace, without charges, any product or part which is found to be defective under normal use and service.

**This warranty does not cover:**

- a) normal maintenance and service;
- b) any products or parts which have been subject to misuse, negligence, accident, improper maintenance, or repair (except by an authorized iio™ repair center), faulty installation or installation contrary to recommended installation instructions;
- c) cosmetic damage.

iio™ OBLIGATION TO REPAIR OR REPLACE, AT iio™ OPTION, SHALL BE THE PURCHASER'S SOLE AND EXCLUSIVE REMEDY UNDER THIS WARRANTY. iio™ SHALL NOT BE LIABLE FOR INCIDENTAL, CONSEQUENTIAL OR SPECIAL DAMAGES ARISING OUT OF, OR IN CONNECTION WITH, PRODUCT USE OR PERFORMANCE.

This warranty applies only within North America, to refrigerators installed for use for PRIVATE SINGLE FAMILY USE. If used for COMMERCIAL, MULTI-FAMILY USE or any other purpose, the warranty will be voided.

Removal or disfigurement of the serial plate, will void the warranty. The purchaser will be responsible for any extra expenses involved in making the refrigerator readily accessible for servicing. The purchaser will be responsible for any extra charges where the installation is in a remote location such as un-assumed roads, islands, and areas known as cottage country, 20 km outside a Metropolitan area or where a technician is not available. Freight damage is not covered by this warranty.

For a iio™ authorized repair center please contact us at: 1-833-446-4461 or you can visit [www.iio.com](http://www.iio.com) for more information.





We do the utmost to ensure that the provided information is complete and accurate, however, images and specifications are subject to change without notice.

Visit [www.iioKitchen.com](http://www.iioKitchen.com) to download the latest version of the user manual.