



## **ALL WEATHER WICKER 3PC GLIDER SET**

### **ASSEMBLY INSTRUCTIONS**

**IF YOU PURCHASED THE CHAIR ONLINE AND HAVE ANY  
QUESTIONS OR CONCERNS**

**PLEASE CONTACT US**

**WITH EMAIL OR TEXT**

**EMAIL: [hiwarrantyservice@outlook.com](mailto:hiwarrantyservice@outlook.com)**

**TEXT: +1 628-263-4608**

## GENERAL BEST PRACTICE FOR ASSEMBLY:

Read all instructions before starting

Clear a flat covered space to begin assembly

Always best to do it with a friend

Note that hardware required is provided for every step

Pay attention to orientation

Letter of the part corresponds to a sticker on the product

Number of the hardware corresponds to its letter in the package

Helpful hints provided along the way

Retain these assembly instructions for future reference.

## WARNINGS:

**Use the correct bolts as indicated. All bolts should be hand tighten until the complete piece is assembled ( This will make the assembly process much easier ). Once the piece is fully assembled, then go back and tighten all bolts with provided tool.**

Regularly check hardware and tighten if necessary.

Use the correct bolts as indicated. **Do not tighten any of the bolts until the chair is completely assembled.**

Do not discard any of the packaging until you have checked that you have all of the parts and fittings required.

Keep children and pets away during assembly. This item contains small parts that can be swallowed by children.

Children should always be under direct adult supervision while using this product.

Chair is for sitting purposes only. Standing on or misuse of chair may result in damage or injury.

**Weight limit is 300 lbs ( 136.4 kg). Not intended for commercial use.**

## MAINTENANCE:

Wash frame and fabric parts with mild soap and water, rinse thoroughly, and dry completely. Do not use bleach, acid, or other solvents on the frame or fabric parts.

The cushions may be washed on the surface only by using mild soap and water or a commercial foaming upholstery cleaner if necessary.





















If washed, rinse well and hang to dry. Do not machine wash or dry.

We recommend the use of furniture covers when not in use.

Inspect and tighten all of the bolts and fasteners on a regular basis to ensure the proper performance and safety of your chair.

In order to prolong the life and beauty of your chair, we recommend that it be stored in a dry and protected area during off season periods.

# PARTS LIST:

Part No.	Part	Qty	Image	Part No.	Part	Qty	Image
1	Chair Back	1		8	Short Bolt (M6x15mm)	8	
2	Seat Panel Frame	1		9	Bolt (M6x28mm)	4	
L3	Left Armrest	1		10	Bolt (M6x36mm)	6	
R3	Right Armrest	1		11	Bolt (M6x41mm)	4	
L4	Left Armrest Support (with one threaded hole)	1		12	Bolt (M6x48mm)	4	
R4	Right Armrest Support (with one threaded hole)	1		13	Washer	26	
L5	Left Armrest Support (with two threaded holes)	1		14	Nut	4	
R5	Right Armrest Support (with two threaded holes)	1		15	Spring Washer	4	
6	U-shaped Fitting	1		16	Back Cushion	1	
7	Chair Base	1		17	Seat Cushion	1	

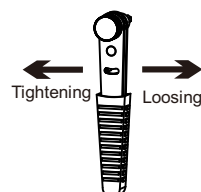
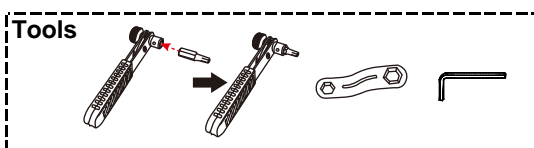



# STEP 1

**PART REQUIRED: L3, R3, L4, R4, L5 & R5**  
**Keep the bolts loose.**

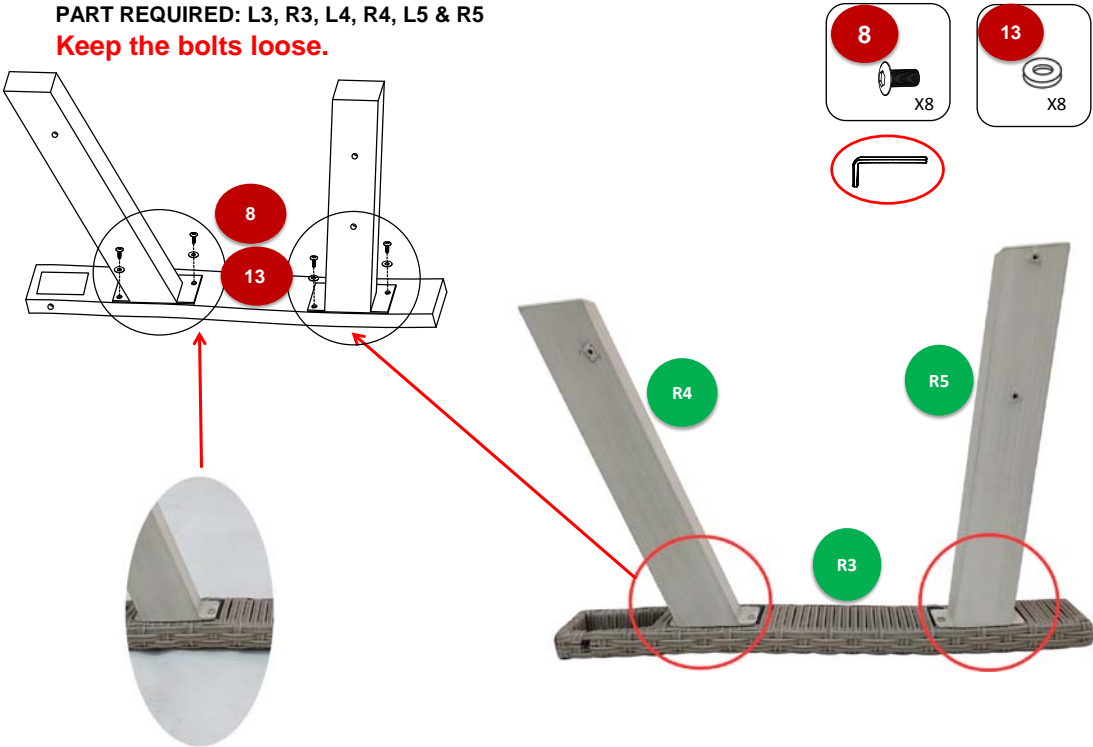

**Note: After assembled, keep all the threaded holes inwards.**

# STEP 2

**PART REQUIRED: 6, 7**  
**Keep the bolts loose.**

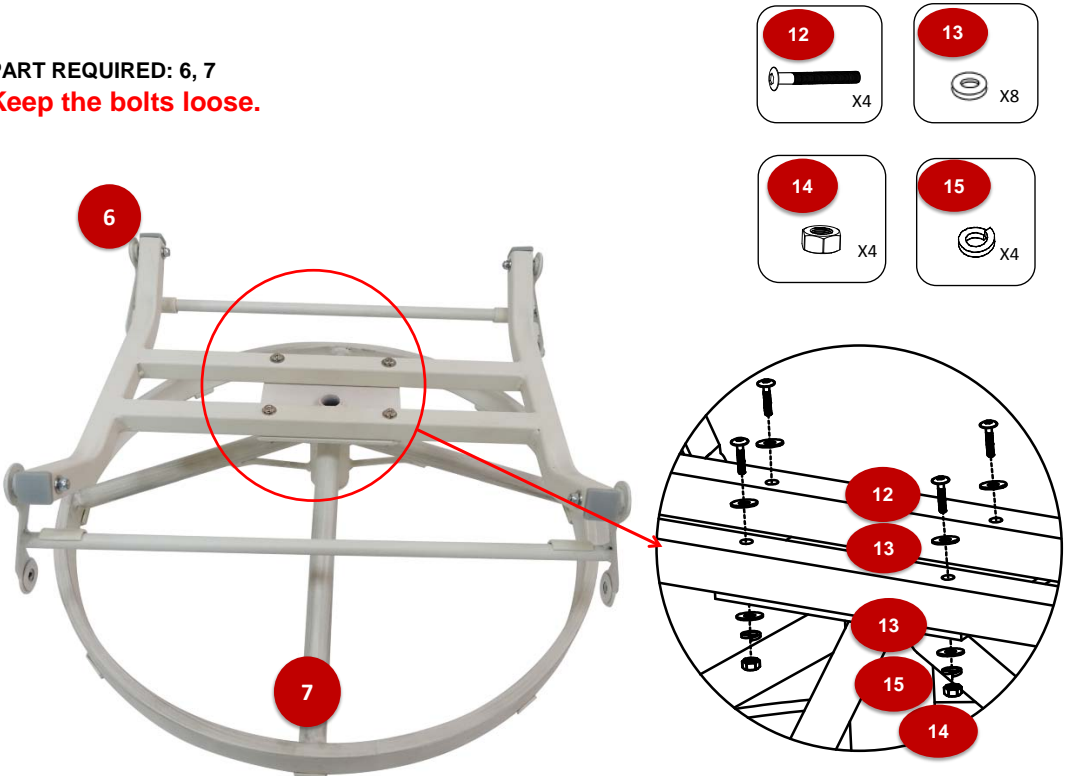

### STEP 3

PART REQUIRED: 1 & 2  
**Keep the bolts loose.**

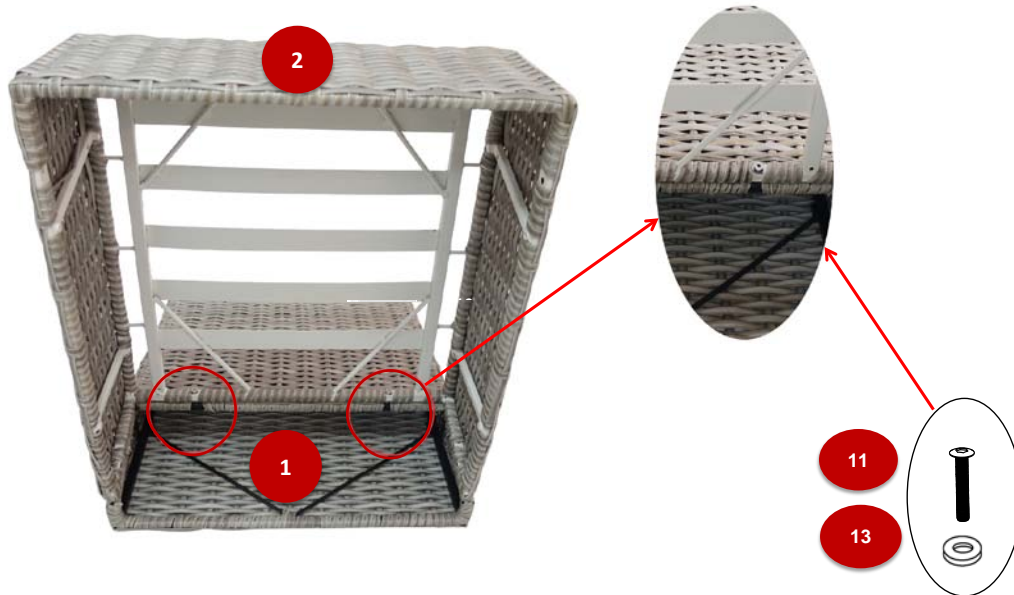
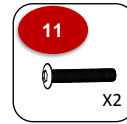

### STEP 4

PART REQUIRED: L3, R3 & 2  
**Keep the bolts loose.**

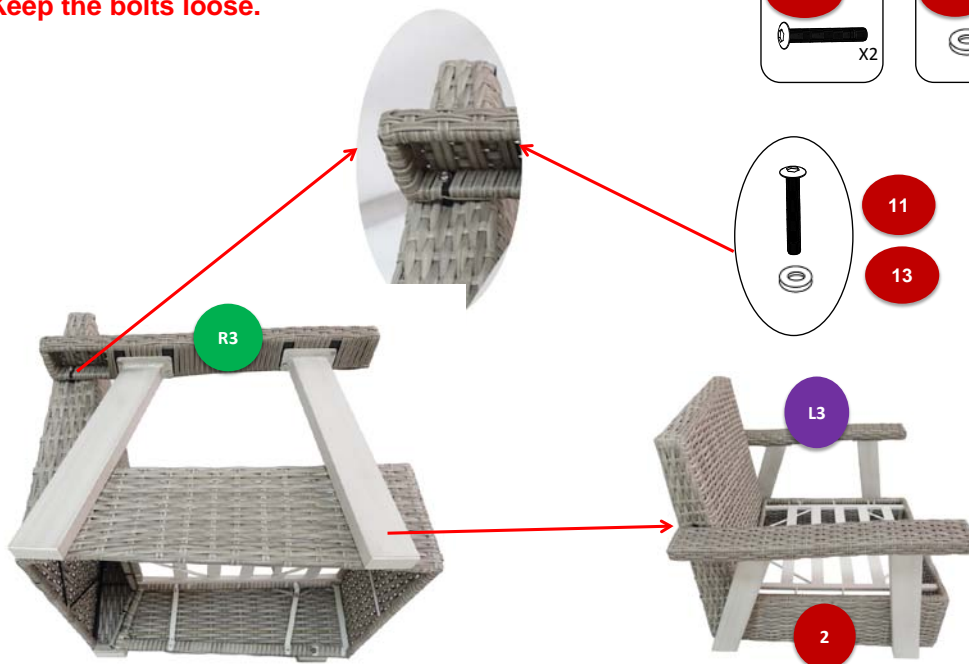
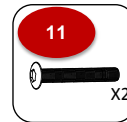

## STEP 5

PART REQUIRED: 2, L4, R4, L5 & R5  
**Keep the bolts loose.**

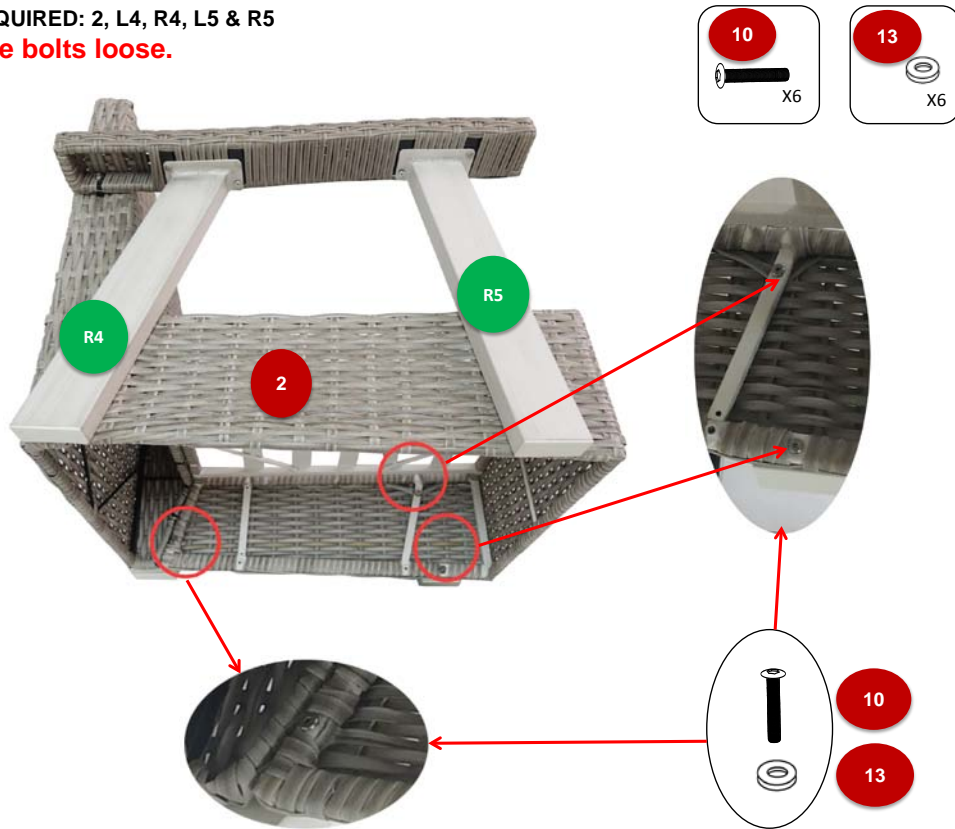

## STEP 6

PART REQUIRED: 2, 6 & 7  
**Keep the bolts loose.**

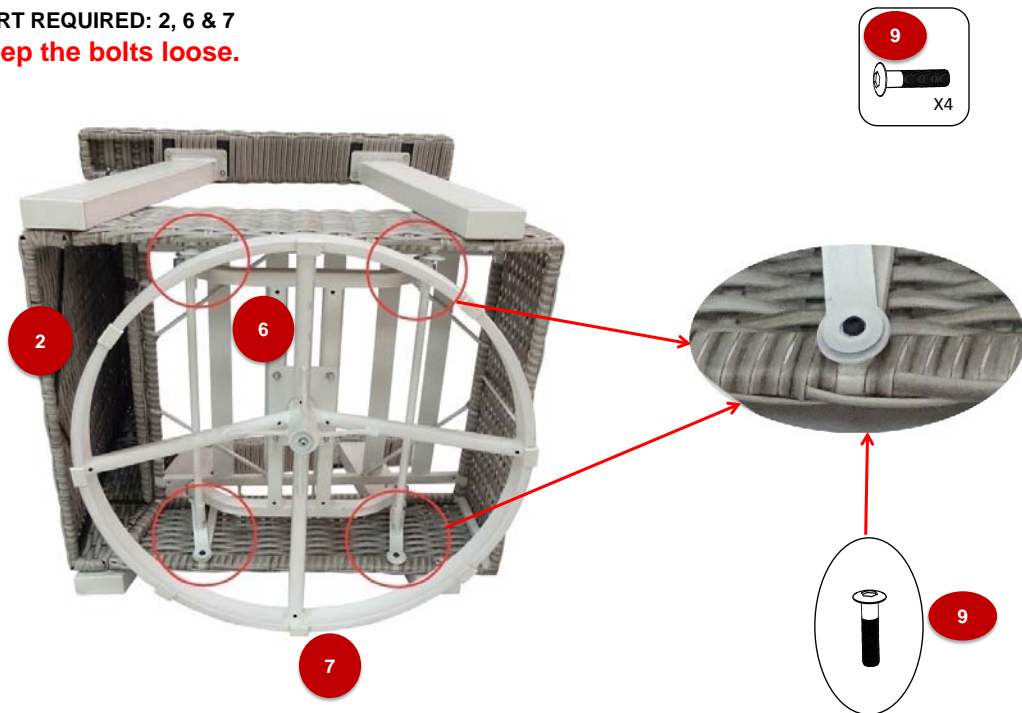

## STEP 7

**PART REQUIRED: 16 & 17**  
**Finished!**



**Caution:**

To ensure one's safety during use of this swivel glider, make sure that all of the bolts are completely tightened. The chair has the ability to swivel and glider; therefore use by young children should be under adult supervised.

**Warranty**

One-year limited warranty.

Proof of purchase (dated register receipt) is required for warranty claims.

It remains the customer's responsibility for freight and packing charges to and from the service center.



# PARTS LIST:

Part No.	Part	Qty	Image	Part No.	Part	Qty	Image
1	Table Top	1		8	Short Bolt (M6x15mm)	8	
2	Table Leg	4		18	Long Bolt (M6x28mm)	4	
3	Table Tray	1		13	Washer	12	

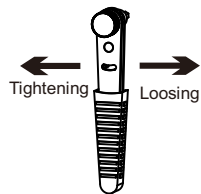
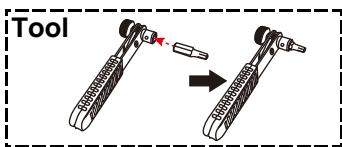

## STEP 1

**PART REQUIRED: 1 & 2**  
**Keep the bolts loose.**

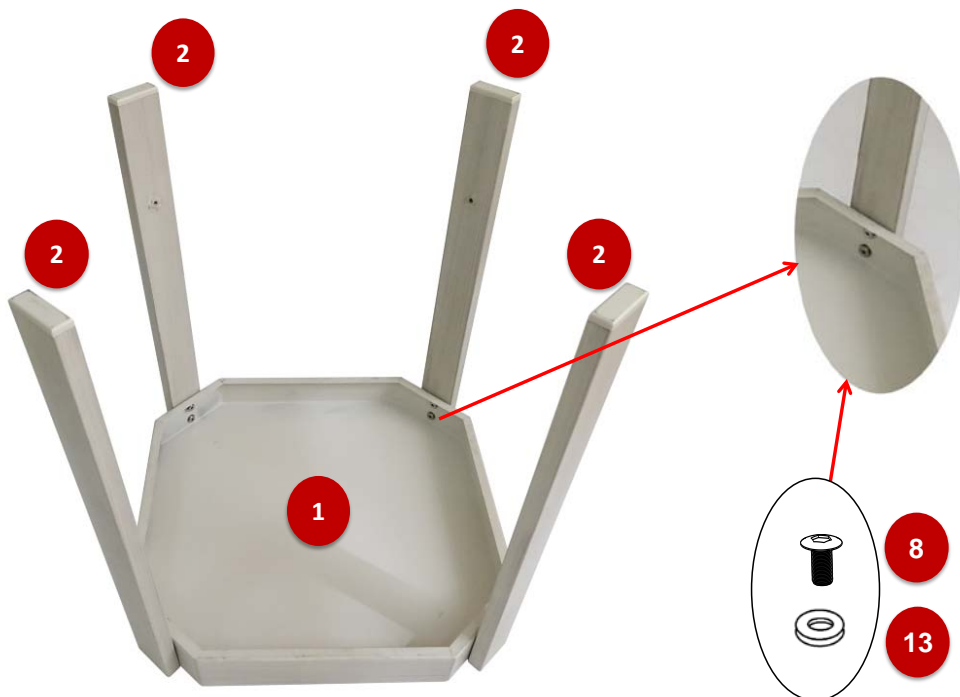
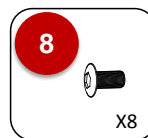

## STEP 2

**PART REQUIRED: 1, 2 & 3**

Tighten all bolts by using the supplied Tool.

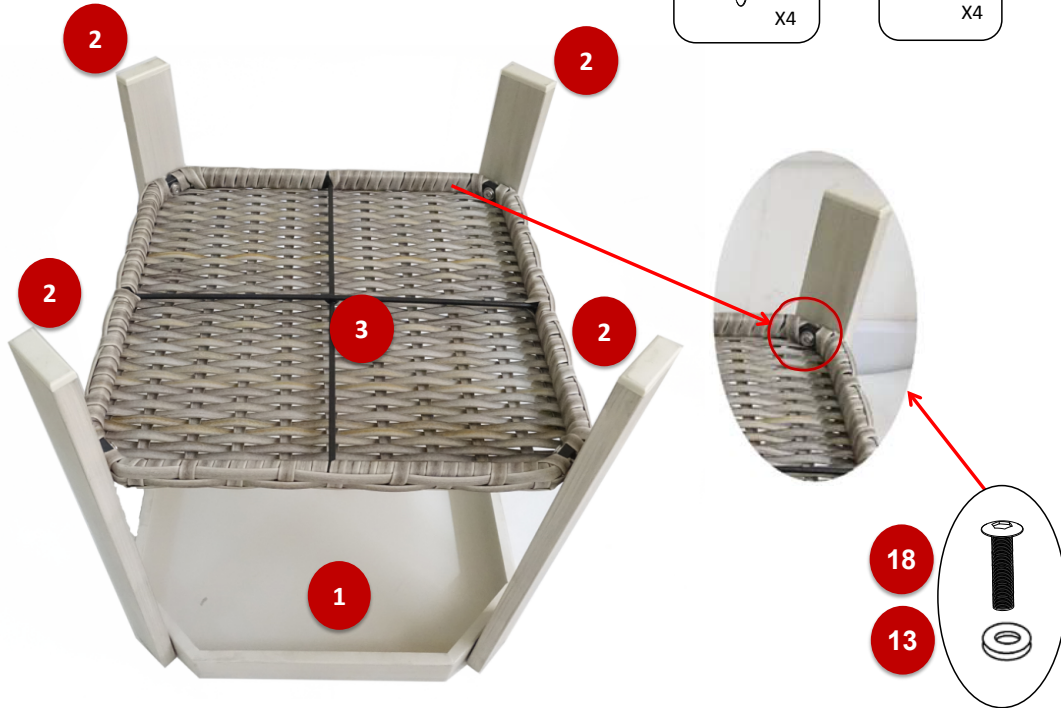

## STEP 3



**Email: [hiwarrantyservice@outlook.com](mailto:hiwarrantyservice@outlook.com)**  
**TEXT: 1 628-263-4608**