



# BB1000

---

OWNER'S MANUAL

---





**PRODUCT INFORMATION**

Important Safeguards & Cautions.....4  
Cautions Before Installation.....6  
Main Unit & Parts.....8

**PRODUCT INSTALLATION**

Installation.....9  
How To Detach the Unit.....12  
Testing & Seat Bumpers.....13

**PRODUCT OPERATION**

Operation.....14  
Maintenance.....25  
Troubleshooting Guide.....28  
Specifications.....30

**WARRANTY**

Warranty.....32



## IMPORTANT SAFEGUARDS & CAUTIONS

### READ ALL OPERATING INSTRUCTIONS BEFORE INSTALLATION

- This product should be installed according to this manual.
- Read this manual carefully and install properly.
- Do not attempt to service this appliance yourself.
- Doing so will void the warranty.

### READ ALL INSTRUCTIONS BEFORE USING

- Do not open the product to repair or remodel. Only qualified service personnel should service this product. Do not use attachments not recommended by the manufacturer.
- Connect this product to cold water supply pipe carrying portable water. Do not connect to an industrial water supply line that does not carry water of drinking quality.
- **Low Temperature Burns-** A burn occurs when the skin has been exposed to high temperatures. However, a low temperature burn may occur when the skin has been in contact with an object at relatively low temperature (about 104°F). Close supervision is necessary when this product is used by children or adults with sensitive skin.
- If using any chemical toilet bowl cleaner, be sure to wipe up any spills that splash onto this Electric Bidet. Do not use benzene or any acid chemical detergent. Only neutral detergent permitted.
- Do not plug in the power cord before connecting the water supply hose.
- This product must be grounded. An approved Ground Fault Circuit Interrupt must be used.
- Do not splash water on this product. Please provide adequate ventilation to avoid damage to electronic components due to high level of humidity. It is necessary to provide adequate ventilation with a fan, open door or open a window when bathing.
- Do not touch the power cord with wet hands. Do not reach for a product that has fallen into water. Unplug immediately!

- This product must be connected to a standard voltage power source. Do not connect power cord if the cord is damaged or broken. Do not plug the unit into a loose electric outlet.
- Please disconnect the power cord when you clean this product or detach it from the toilet bowl. Do not supply electrical power to the unit until the plumbing work has been completed.
- Keep the electrical cord away from heated surfaces to prevent a fire hazard. Also Keep any flammable materials away from this product at all times.

### CAUTION

- Never operate this product if it is not working properly, if it has been dropped or damaged, or dropped into water. Return the product to a service center for examination and repair.
- Do not obstruct or put anything into the dry air outlet. Do not apply excessive force to the shower nozzle.
- Do not stand or sit on the seat cover lid. It is not designed to support a user's body weight.
- Allow the seat and lid to close automatically do not force the lid closed.
- Do not strain or push the connected hose and tube connector. It may cause water leakage. Never drop or insert any object into any opening or hose. Use proper plumbing supplies if any modifications are to be made.
- Use this product only as described in the operating instructions. Never use while sleeping or drowsy. Do not use while bathing.
- Be careful so that this product does not become stained with excrement and urine.
- Drain the water from the unit and unplug the power if it is not going to be used for an extended period of time.

### SAVE THESE INSTRUCTIONS



**WIRING REQUIREMENT**

This product **MUST** be plugged into a regular voltage Grounded GFCI outlet (North America 120V ac, 60Hz/ Europe 220-240V ~, 50/60Hz). The rated power consumption is 660W/600-700W. In locations where only a standard two-prong outlet is available, it is the responsibility of the user to install a grounded three-prong outlet. Using a higher voltage is dangerous and may result in a fire or other accident. This product is not responsible for damage resulting from the use of it on other than specified voltage, or operating it without proper grounding.

**WARNING**

This product must be on a separate circuit. No other appliance should share the circuit with this product. Sharing a circuit could cause the branch circuit fuse to blow or the circuit breaker to trip. Continuous usage under these conditions could result in fire or property damage.

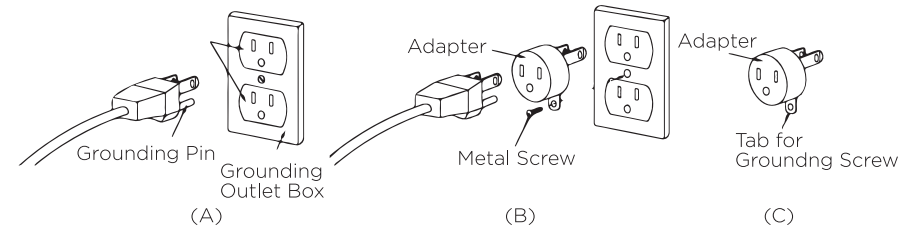

**GROUNDING INSTRUCTIONS**

- This product has a three-prong grounding plug, which must be plugged into an outlet that is properly installed and grounded. In the event of an electrical short circuit, grounding reduces the risk of electric shock by providing an escape wire for the electric current. If repair or replacement of the cord or plug is necessary, do not connect the grounding wire to either flat blade terminal. The wire with insulation having an outer surface that is green with or without yellow stripes is the grounding wire. Check with a qualified electrician or serviceman if the grounding instructions are not completely understood, or if in doubt as to whether the product is properly grounded.
- This product is for use on a nominal 120V circuit, and has a grounding plug that looks like the plug illustrated in sketch A in Figure 1. A temporary adapter, which looks like the adapter illustrated in sketches B and C, may be used to connect this plug to a 2-pole receptacle as shown in sketch B if a properly grounded outlet is not available. The temporary adapter should be used only until a properly grounded outlet (sketch A) can be installed by a qualified electrician. The green colored rigid ear, lug, or the like extending from the adapter must be connected to a permanent ground such as a properly grounded outlet box cover. Whenever the adapter is used, it must be held in place by a screw.

**THIS APPLIANCE HAS TO BE GROUNDED.**



## OPTIONAL GROUNDING INSTRUCTIONS

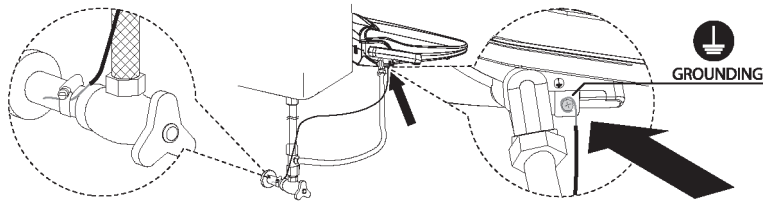

## DANGER

IMPROPER USE OF GROUNDING CAN RESULT IN A RISK OF ELECTRIC SHOCK. ELECTRIC WIRING HAS TO BE DONE IN ACCORDANCE WITH ALL LOCAL CODES, OR IN THE ABSENCE OF LOCAL CODES, WITH THE NATIONAL ELECTRICAL CODES.

The use of an extension cord is not recommended or advised. If it is necessary to use an extension cord, use only a three-prong extension cord (one to one), and a three slot built-in GFCI receptacle that will accept the plug on this product. The marked rating of the extension cord should be equal to or greater than the electrical rating of the unit (10amp). Consult a qualified electrician or service person if you are not sure whether the unit is properly grounded.

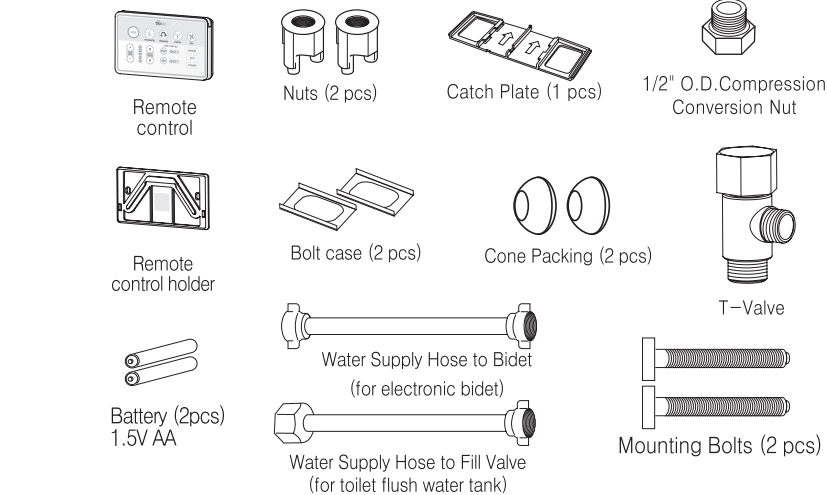
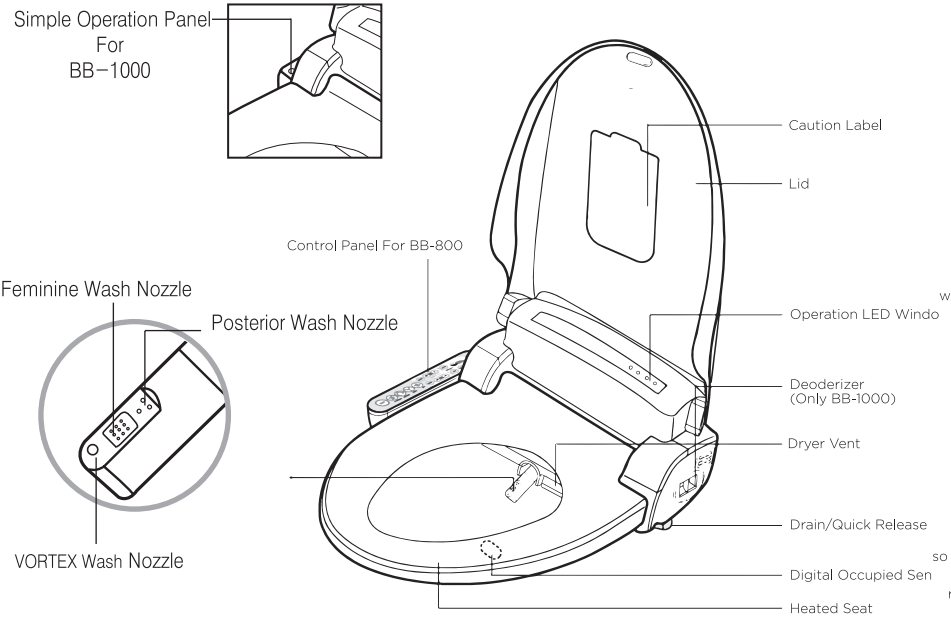

**CAUTION BEFORE INSTALLATION**

- Do not plug in before installation
- If you need an electric power system or extension, please consult a qualified electrician.
- Please contact our service center at 847.458.2334 when you want to reinstall the bidet product (move or replacement).

**1. Turn off the water.**

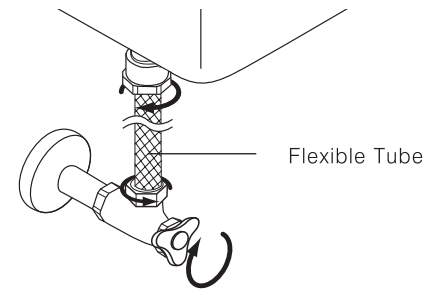

**2. Remove the existing seat and lid.**



- Shut off the water supply valve. Drain the toilet tank completely. Then remove the existing fill valve water supply hose.
- Remove mounting bolts to release existing toilet seat from the toilet.



### 3. Connect the T-valve.

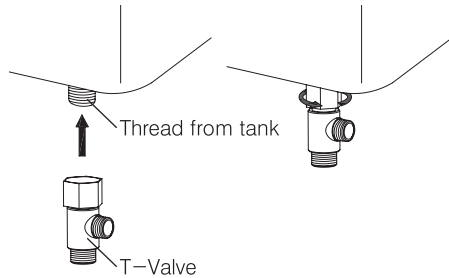

- Remove existing supply hose connected to the toilet tank. Make sure not to damage the water supply hose.
- Install the T-valve at the thread from the tank.

### 5. Installation Catch Plate.

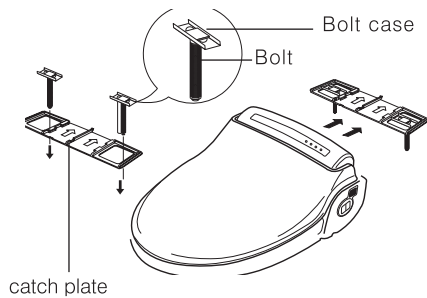

- Place the plate and guides over each mounting hole. Insert the mounting bolts through the plate and mounting holes.

### 4. Connect the water supply hose to the assembled T-valve.

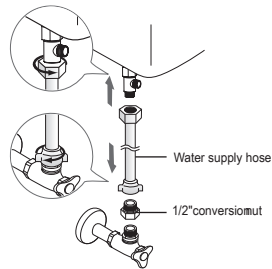

- Remove the existing supply hose from the toilet tank
- If your shut off valve is 1/2" size, use supplied 1/2" conversion nut as shown.

### 6. Bolt and Nut Assembly.

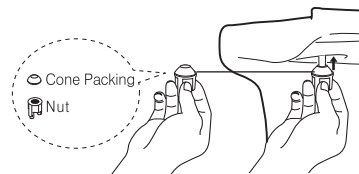

- Slide cone packing and washers onto the bolts then fasten to securely mount bidet seat to toilet.

### 7. Assembly.

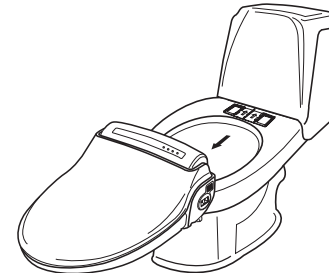

- Slide this product onto the catch plate centering the unit with the guide arrows on the base.
- You will hear a click once this product is securely mounted to the catch plate.
- This product will feel a little loose on the toilet bowl. Adjust the fit from front to back and side to side for balance.
- Tighten the nuts on both bolts securely.

### 8. Bidet Hose Assembly.

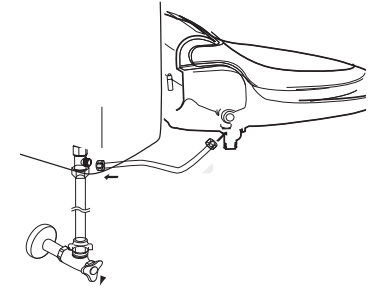

- Customers should use the new hose set provided with the product. Do not use used set again.



**9. Deodorizer Installation**

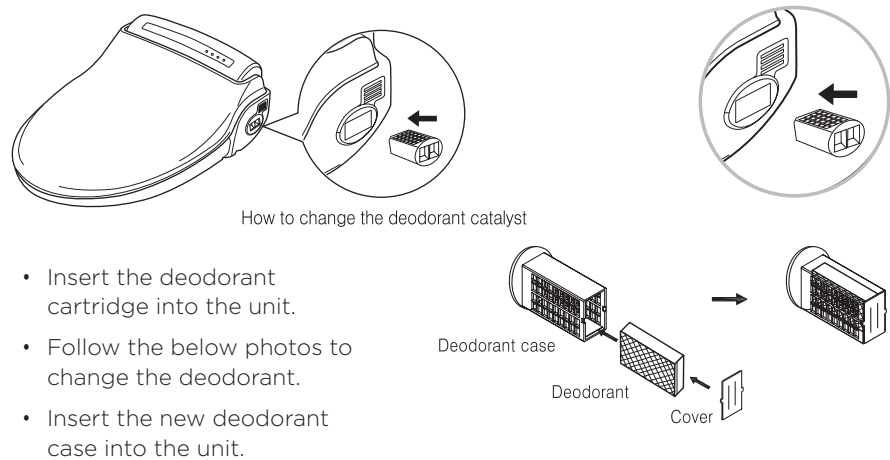

- Insert the deodorant cartridge into the unit.
- Follow the below photos to change the deodorant.
- Insert the new deodorant case into the unit.

**10. Wireless Remote Mounting Guide**

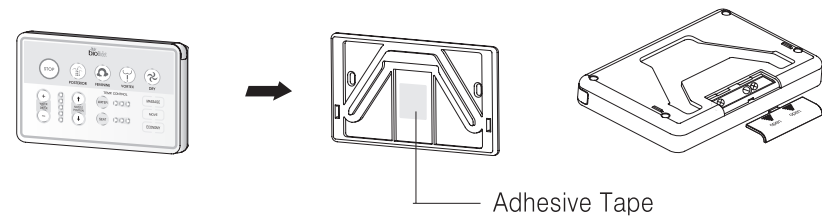

- Remove adhesive from the back of the bracket and place the bracket where desired.
- Place the remote into the remote bracket.
- Insert the batteries and close the batter cover.

**DO NOT TURN UNIT UPSIDE DOWN.**

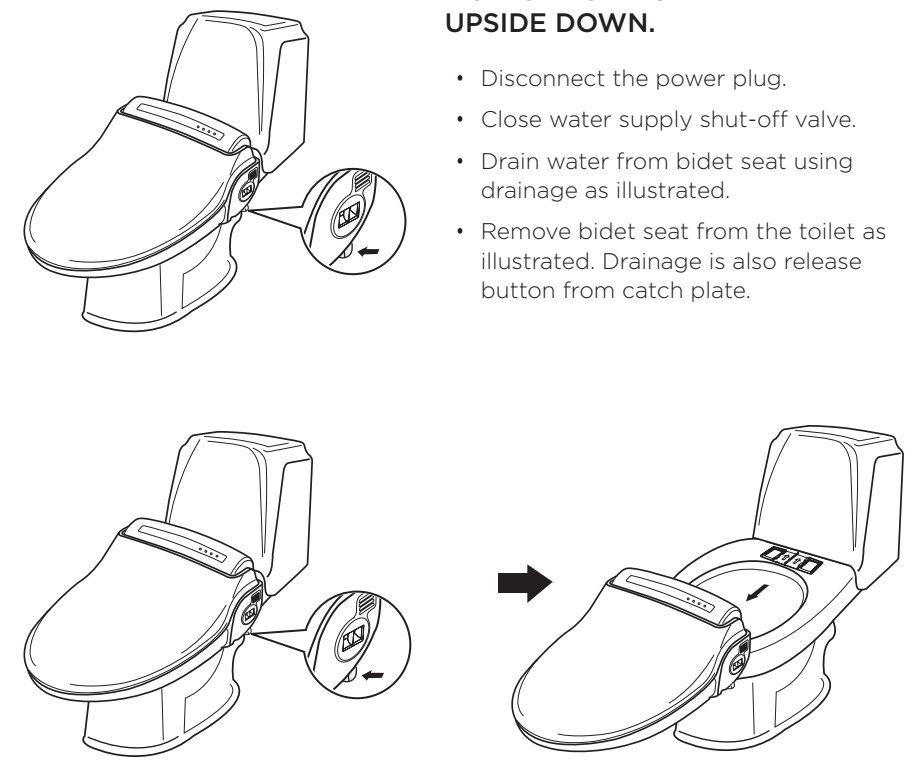

- Disconnect the power plug.
- Close water supply shut-off valve.
- Drain water from bidet seat using drainage as illustrated.
- Remove bidet seat from the toilet as illustrated. Drainage is also release button from catch plate.



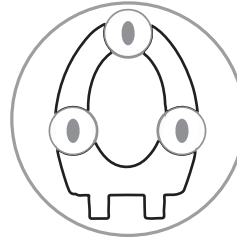
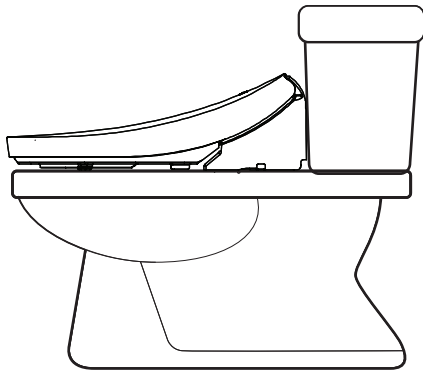

- Plug the power cord into the outlet, and then the water tank will be filled with water in 2 minutes.
- Check all the functions. Cover the toilet using the sheet of plastic wrap on the unit to prevent the washing water from being sprayed out of the toilet. Then check for all functions described in this manual.
- There are possibilities of water coming out that remains in the unit while heating.
- After installing your bidet attachment, check to see if there is a gap between the toilet base and toilet seat.
- If necessary, place the bumpers on the underside of your toilet seat as indicated above.



Adjust the water pressure and warm air dryer temperature.



Adjust the oscillation function and nozzle position (5 levels).



Adjust the water and seat temperature (4 levels).



Power Saving mode button.

**When you sit on this product, please sit down on the central position in order to activate the sensor.**

**After an extended wash, allow water to be reheated for 3 minutes.**

**Preparation**

- Check for any water leaks
- Plug the unit into the proper power source and the LED power light will start flashing,
- Wait until the LED power light stops flashing and becomes solid red.
- The water tank will be filled after pushing a “Wash” button.
- When the water tank is filled the buzzer “Beeps” continuously, after the water tank is full the buzzer will end with “One Solid Beep.”



### OPERATION

#### Sit Down On the Seat

- When you sit down on the seat, the ORANGE LED lamp on the control panel will light up.
- When the digital sensor on the seat is activated, the operation LED window on the main unit will light “Occupied sensor” and simultaneously, the deodorizer fan will start to work.

### STOP

- Press this button to stop all operation.

### POSTERIOR WASH

- Press “Posterior Wash.” Automatically, the nozzle comes out and sprays warm water to posterior.
- Additional functions during your Posterior Wash experience are available such as Oscillation and Massage.

### FEMININE WASH

- Press “Feminine Wash.” Automatically, the nozzle comes out and sprays warm water to feminine area.
- Additional functions during your Feminine Wash experience are available such as Oscillation and Massage.

### TURBO WASH

- Press “Turbo Wash,” the nozzle spray is more or focused to produce the effect of strong wash, to help stimulate bowel movement.
- Press “Water pressure - High & Low button” to adjust the water pressure.

### CAUTION!

DO NOT ALLOW CHILDREN TO USE THE TURBO WASH FUNCTION! SUPERVISION IS STRONGLY RECOMMENDED FOR THE ELDERLY OR OTHER PERSONS THAT MAY HAVE LIMITATIONS IN BODY MOVEMENT, ILLNESS, OR DISABILITIES!



### TURBO WASH

- Press “Turbo Wash” continuously for 3 to 5 seconds. Automatically, the water nozzle comes out and sprays a warm stream of water to the posterior center of the rectum.
- If necessary, adjust “Position” of water stream with the  $\uparrow/\downarrow$  buttons.
- Press “Water Pressure High & Low button”  $\oplus/\ominus$  to adjust the water pressure to your desired comfort.
- Press the “STOP” button when you feel your abdomen is full or wait until the “Turbo Wash” function stops, approximately 1 minute.
- You will shortly feel the urge to push the water out of your colon, push the water and feces out as thoroughly as you can,
- Relax for a few minutes and be sure you feel your colon is empty and then use the “Posterior Wash” and “Air Dry” function to finish.

### WARM AIR DRYER

- Press “Dry” and warm, dry air is gently directed to washed area for about 3 minutes.
- You may adjust the warm air temperature by pressing High  $\oplus$  and Low  $\ominus$  buttons.

This product memorizes the air temperature of prior use.

### WATER PRESSURE ADJUSTMENT

- After sitting down on this product, the LED lamp for water pressure on the Power Control will light at third or middle level.
- Press High  $\oplus$  or Low  $\ominus$  to adjust the pressure of the water spray to your desired comfort level.

### WARM WATER TEMPERATURE AND SEAT TEMPERATURE ADJUSTMENT

- The temperature of water and seat are adjustable to the desired level by pressing the “WATER” and “SEAT” button.

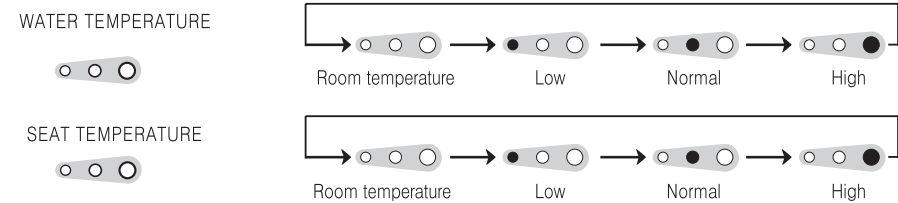

### NOZZLES POSITION ADJUSTMENT

- Nozzle position is adjustable to the desired position by pressing “Front”  $\uparrow$  or “Rear”  $\downarrow$  button from 1 to 5 positions.
- After using this product, the nozzle will return to position 3.

### OSCILLATION (Nozzle Movement Function)



- When using Posterior for Feminine Washing functions, pressing the “MOVE” button will provide a short-motion, front to back oscillating spray for a much wider cleansing experience. Note: This function will not work during the “Turbo Wash” function.
- You may change the position of the Oscillating spray by pressing the “MOVE” button again and “Front”  $\uparrow$  or “Rear”  $\downarrow$  buttons simultaneously.
- Push the “MOVE” button again and the oscillation motion will stop automatically.



### Auto-Setting of Oscillation Feature

You can set this function to automatically oscillate whenever the seat is occupied and the Posterior or Feminine washes are in operation.



- Do not sit on the product.
- Press the “MOVE” button for 3 seconds or until you hear a single chime.
- Sit on the product and proceed with Posterior or Feminine Wash.

NOTE: In the automatic setting, you may still adjust the position of the Oscillating spray by pressing the “Front”  or “Rear”  buttons.

### Canceling the Automatic Oscillation Function

- Do not sit on the product
- Press the “MOVE” button for 3 seconds or until you hear a double Chime.



### MASSAGE

- When using the Posterior Wash or Feminine Wash Functions, pressing the “MASSAGE” button will provide you with a pulsation spray.
- You may change the pressure of the spray by pressing the “High”  button or “Low”  buttons.
- Push the “MASSAGE” button again and the pulsating action will stop automatically.

### AUTO SETTING OF MASSAGE FEATURE

You can set this function to automatically pulsate whenever the seat is occupied and the Posterior or Feminine washes are in operation.

- Do not sit on the product
- Press the “MASSAGE” button for 3 seconds or until you hear a single chime.
- Sit on the product and proceed with Posterior or Feminine Wash.

NOTE: In the automatic setting, you may still adjust the pressure of the pulsating spray by pressing the “High”  or “Low”  functions.

### CANCELING THE AUTOMATIC OSCILLATION FUNCTION

- Do not sit on the product
- Press the “MASSAGE” button for 3 seconds or until you hear a double chime.

### ECONOMY (Energy Saving Mode)

- The ENERGY SAVER is not on when the LED light is off.
- Press button once to choose “ECONOMY 1”
- Press button again to choose “ECONOMY 2”
- Press button a third time to turn “ECONOMY” off

The ECONOMY 1: the water temperature will be kept at 90°F (32°C) when it is not being used, and raise the water temperature back to normal level during the time of use. It takes about 5 days for the unit to “learn,” and “remember,” the usage pattern of the user(s).



### NOZZLE CLEANING (Automatically)

- This product has an automatic nozzle self-cleaning function that cleans the nozzle before and after each use.

### NOZZLE CLEANING (Manual)

- Nozzle can be cleaned manually by pressing “Posterior Wash” button for 3 seconds without being occupied on the seat and the nozzle will come out without spraying water. After cleaning the nozzle, Press “Stop” button to return the nozzle to the stand-by mode.

### CHIME SOUND ON/OFF SET

- While sitting on the product, press “MOVE” button for 3 seconds and you can hear the chime sound change to ON or OFF.

### CLEANING THE NOZZLE

- When the “Posterior Wash” button is pressed for 3 seconds without occupying the seat, the nozzle can be cleaned with a soft toothbrush.
- After cleaning the nozzle, push the “Stop” button once again, and the nozzle retracts itself.

### CLEANING THE BODY OF THE UNIT

- When you clean this product, do not use thinner, benzene, or toilet bowl cleaner. It may cause damage to the surface of unit.
- Use a wet cloth when you clean this product.
- Do not spray water directly on to this product.
- When you clean this product, disconnect the power plug.

### WATER FILTER MAINTENANCE

- Use of external water filter is only recommended in areas with known hard water issues. If a filter is used, it must be replaced every 3 months.
- This product is designed and intended for use exclusively with Bio Bidet Carbon & Iodine water filters. The purchase or use of any other water filter is not the responsibility of BBC Innovation LLC. As such, any use of non Carbon or Iodine water filters is prohibited and will void the warranty for those Bio Bidet products. Bio Bidet will not be responsible for any resulting damages or claims related to the misuse or distribution of non Bio Bidet Carbon & Iodine filters.



### WATER DRAINING

If you do not intend to use this product for 14 days or longer, drain the water from the product's warm water tank

- Disconnect the power plug.
- Close the water shut off valve
- Press the drain lever until the water is completely drained from the water tank.
- To re-supply water after draining, open the water shut off valve.

Do not drink the drained water. Do not insert finger into the drain hole. Before draining, unplug the power cord and wait 30 minutes until the unit has cooled down.

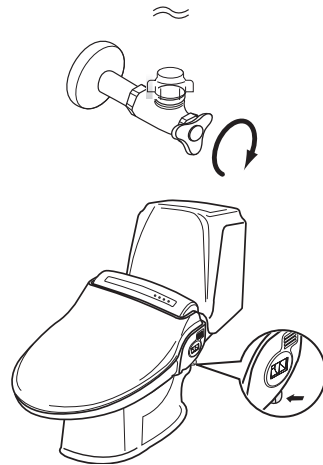

### MAINTENANCE FOR WINTER SEASON

- Check the power cord if it is plugged in or not.
- Keep the water temperature on "Middle or High Level" to prevent water from freezing.
- If you do not intend to use the unit for 14 days or longer, disconnect the power plug and drain the water.

### CLEANING THE STRAINER

THIS PRODUCT WILL NOT OPERATE PROPERLY IF THE STRAINER IS CLOGGED. PLEASE CLEAN THE STRAINER REGULARLY.

- Close the water shut off valve.
- Flush the toilet to empty the water reservoir.
- Unscrew the water hose nut.
- Clean the strainer with a small brush or water.
- Re-screw the water hose nut.
- Open the water shut off valve.

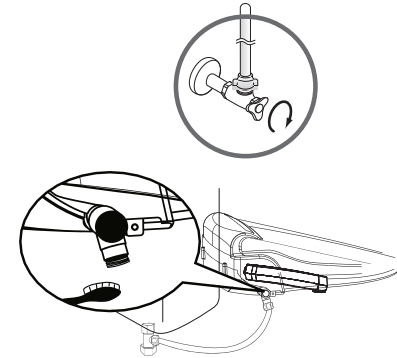



PROBLEM	POSSIBLE CAUSE	POSSIBLE SOLUTION
The washing water does not spray	<ul style="list-style-type: none"> <li>The water tank is not filled.</li> <li>The shutoff valve is closed.</li> <li>Freezing inside the main unit or the water supply pipe.</li> </ul>	<ul style="list-style-type: none"> <li>Wait about one minute. Press the desired washing button once again.</li> <li>Turn the shutoff valve to open.</li> <li>Heat the room (for about two hours). Operating the unit while parts are frozen will cause a malfunction.</li> </ul>
The unit is not operating.	<ul style="list-style-type: none"> <li>Disconnect the power cord.</li> <li>The seat is not occupied</li> </ul>	<ul style="list-style-type: none"> <li>Connect the power cord. If problem persists, check the power cord supply system in your house</li> <li>Occupy the seat (The unit has an occupied seat sensor).</li> </ul>
Water is leaking.	<ul style="list-style-type: none"> <li>Check the water supply system</li> </ul>	<ul style="list-style-type: none"> <li>If the water is leaking from the main unit, call the service center or the place you purchased the unit.</li> </ul>

PROBLEM	POSSIBLE CAUSE	POSSIBLE SOLUTION
The washing water pressure is weak	<ul style="list-style-type: none"> <li>The water pressure level is set to "LOW"</li> <li>The strainer is clogged.</li> </ul>	<ul style="list-style-type: none"> <li>Set the water pressure to be "HIGH."</li> <li>Clean the strainer</li> </ul>
The washing water is not warm	<ul style="list-style-type: none"> <li>The water temperature is set to "LOW."</li> <li>Continuous Operation has depleted the supply of warm water.</li> </ul>	<ul style="list-style-type: none"> <li>Set the water pressure to "HIGH."</li> <li>Clean the strainer.</li> </ul>
The seat and dryer is not warm	<ul style="list-style-type: none"> <li>The seat &amp; dryer temperature is set to "LOW."</li> </ul>	<ul style="list-style-type: none"> <li>Set the seat &amp; dryer temperature to "HIGH."</li> </ul>



SPECIFICATION		BB-800
Power Rating		Australia or Europe: 240-240V-, 50/60Hz, 600-700W America or Canada: 120Vac, 60Hz, 660W
Water Inlet Type	Type	Direct Inlet flow type
	Water inlet pressure	0.04 - 0.74MPa (0.4 - 7.5 kgf/cm)
Power cord		(1.2m (4feet): America) / (1.8m: Australia or Europe)
Wash Device	Posterior Wash	Max 1.2 l/min (Max. 0.32 GPM)
	Feminine Wash	Max 1.2 l/min (Max. 0.32 GPM)
	Water Pressure Adj.	5 Levels
	Warm Water Temp.	Room Temp, Low, Normal, High
	Heater	55W
Safety Devices		Thermal fuse, Thermal switch, Float switch
Heated Seat	Temperature	Room Temp, Low, Normal, High
	Heater	55W
	Safety Device	Thermal fuse
Warm Air Dryer	Adjustable Dry Temp. (Room Temp - 55°C)	Yes
	Heater/250W	
	Safety Device	
	(Thermal fuse, bitmetal)	

SPECIFICATION		BB-800	
Turbo Function		Yes	
Inlet water temperature		3°C-35°C (37.4°F - 95°F)	
Ambient Temperature		3°C - 40°C (37.4°F - 104°F)	
Dimension	ELONGATED (Control)	ROUND (Control)	
	W:495mm (19.4in) L:525mm (20.6in) H: 185mm (7.28in)	W: 495mm (19.4in) L: 493mm (19.4in) H: 185mm (7.28in)	
Weight (kg)		5.3kg	5.4kg





## THREE YEAR LIMITED WARRANTY

- 100% Coverage of all parts and labor for the entire product for the first year from original date of purchase
- 75% Coverage of all parts for the entire product for the second year from the original date of purchase
- 50% Coverage of all parts and labor for the entire product or the third year from original date of purchase.

BBC Innovation LLC warrants its product to be free from manufacturing defects under normal use and service for a period of three years prorated base as above from date of purchase. This warranty is extended only to the ORIGINAL PURCHASER.

BBC Innovation LLC's obligations under this warranty are limited to repair or replacement, at BBC Innovation LLC's option of products or parts found to be defective, provided that such products were properly installed and used in accordance with instructions, BBC Innovation LLC reserves the right to make such inspections as may be necessary in order to determine the cause of the defect. BBC Innovation LLC will not charge for labor or parts in connection with warranty repair or replacements. BBC Innovation LLC is not responsible for the cost of removal, return and/or re-installation of products.

This warranty does not apply to the following items:

- Damage or loss sustained in a natural calamity such as fire, earthquake, flood, thunder, electrical storm, etc.
- Damage or loss resulting from any unreasonable use, misuse, abuse, negligence, or improper maintenance of the product.
- Damage or loss resulting from removal, improper repair, or modification of the product.
- Damage or loss resulting from sediments or foreign matter contained in a water system.
- Damage or loss resulting from improper installation or from installation of a unit in a harsh and/or hazardous environment.

This warranty gives you specific legal rights. You may have other rights which vary from state to state.

To obtain warranty repair service under this warranty, you must take the product or deliver it prepaid to a BBC Innovation LLC service facility together with a letter stating the problem, or contact a BBC Innovation LLC distributor or products service contractor, or write directly to BBC Innovation LLC, 7900 S RT 31 Crystal Lake IL 60014.

This written warranty is the only warranty made by BBC Innovation LLC. Repair or replacement as provided under this warranty shall be the exclusive remedy available to the purchaser. BBC Innovation LLC shall not be responsible for loss of the product or for other incidental, special, or consequential damages or expenses incurred by the purchaser, or for labor or other costs due to installation or removal, or costs of repairs by others, or for any other expense not specifically stated above. Except to the extent prohibited by applicable law, any implied warranties, including that of merchantability or fitness for use, are expressly limited to the duration of this warranty. Some states do not allow limitations on how long an implied warranty lasts, or the exclusion or limitation of incidental or consequential damages, so the above limitation and exclusion may not apply to you.

**WARNING!** BBC Innovation LLC shall not be responsible or liable for any failure of, or damage to, this plumbing product or product component caused by either chloramines in the treatment of public water supply or in-tank bowl cleaners containing chlorine (calcium hypochlorite).

**Note: The use of high concentration of chlorine or chlorine related products can seriously damage the fittings. This damage can cause leakage and serious property damage.**



## INFORMATION TO THE USER (For America)

This equipment has been tested and found to comply with the limits for a Class B digital device, pursuant to part 15 of the FCC Rules. These limits are designed to provide reasonable protection against harmful interference in a residential installation. This equipment generates, uses and can radiate radio frequency energy and, if not installed and used in accordance with the instructions, may cause harmful interference to radio communications. However, there is no guarantee that interference will not occur in a particular installation. If this equipment does cause harmful interference to radio or television reception, which can be determined by turning the equipment off and on, the user is encouraged to try to correct the interference by one more of the following measures:

- Reorient or relocate the receiving antenna
- Increase the separation between the equipment and receiver.
- Connect the equipment into an outlet on a circuit different from that to which the receiver is connected.
- Consult the dealer or an experienced radio/TV technician for help.

## WARNING

Changes or modifications not expressly approved by the manufacturer could void the user's authority to operate the equipment.

NOTE: The manufacturer is not responsible for any Radio or TV interference caused by unauthorized modifications to this equipment. Such modifications could void the user's authority to operate the equipment.

For more information, please contact your dealer or us.

## BBC INNOVATION LLC

7900 S RT 31 Crystal Lake IL 60014

T: 847.458.2334

F: 847.854.1296

Email: [support@biobidet.com](mailto:support@biobidet.com)

[www.biobidet.com](http://www.biobidet.com)

# Thank You



Technical Support/Customer Service  
7900 S Route 31 Crystal Lake, IL 60014  
T: 847.458.2334  
U.S. TOLL FREE: 877.339.5214

[support@biobidet.com](mailto:support@biobidet.com)  
[www.biobidet.com](http://www.biobidet.com)