









Recliner Assembly Instructions

Your recliner comes packaged in one box.

DO NOT use any sharp objects to open plastic wrapped components as damage to product or components may result.

Carefully remove all of the components from the packaging and set aside for assembly. Assemble on a soft surface to prevent scratching the finish.

Parts List		Hardware List	
A 1 x Back		E 1 x Handle	
B 1 x Seat		F 1 x Bolt	
C 1 x Left Back wing		G 1 x Wing Nut	
D 1 x Right Back wing			
		 Hardware bag can be found under the seat	

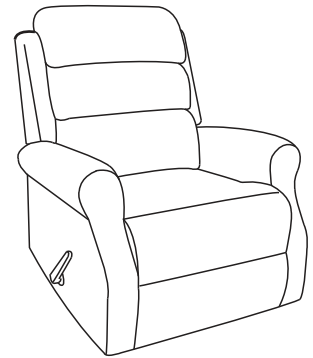

Assembly

Step 1

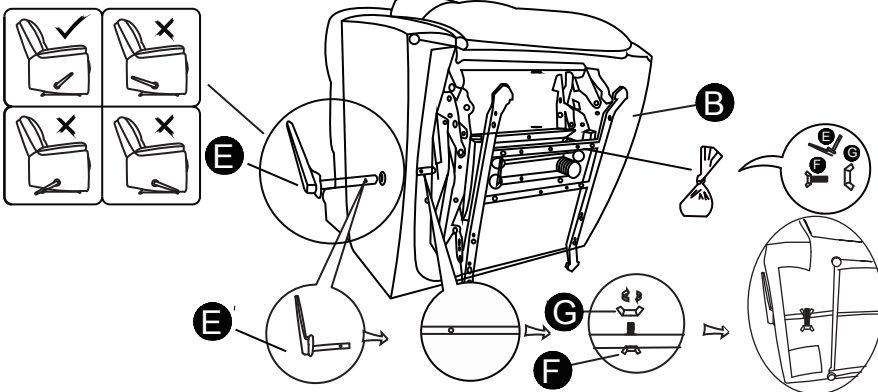

Step 2

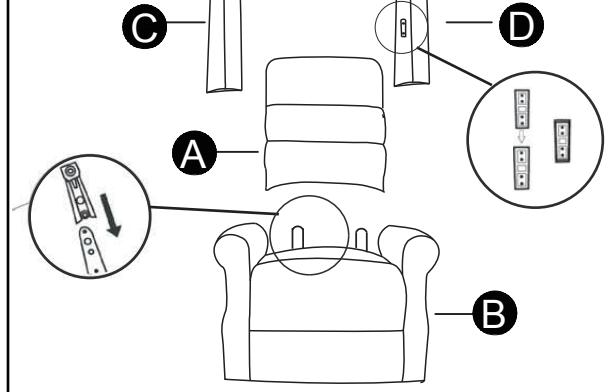

Step 3

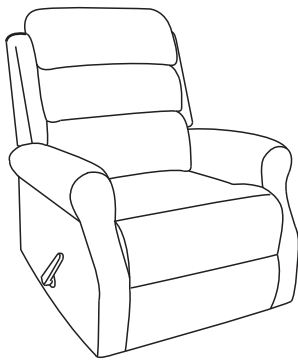

Please note the handle is used to release the foot rest. Use your arms to recline all the way back. To close, please use your legs to push the foot rest down.

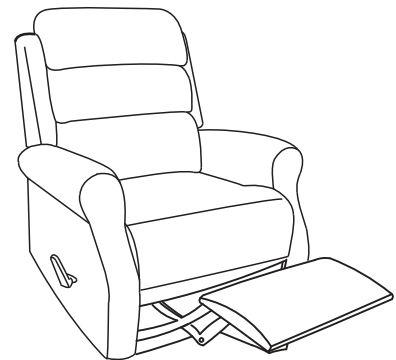

Your recliner style may differ from images. Care for your furniture by periodically tightening all bolts. Fabric will fade or discolor in direct sunlight. Minimize exposure to direct sunlight to extend the life of your furniture.

One Year Warranty: The furniture is warranted against defects in workmanship and materials. Items covered would be seam slippage, frame structural integrity, fit and finish of parts. Items not covered would be product abused by the user, normal wear and tear, stains or discoloration due to use, damage in any transportation. Softening of foam is considered normal wear and tear and is not covered by warranty. Warranty is for PARTS ONLY and does not include transportation and labor costs associated with any warranty claim.

CAUTION: Tighten all components securely before use. Failure to do so may result in personal injury.

Customer Support: 866-238-0531
 Mon-Fri 8:00am - 4:30pm CST
customerservice@furniturequestions.com