

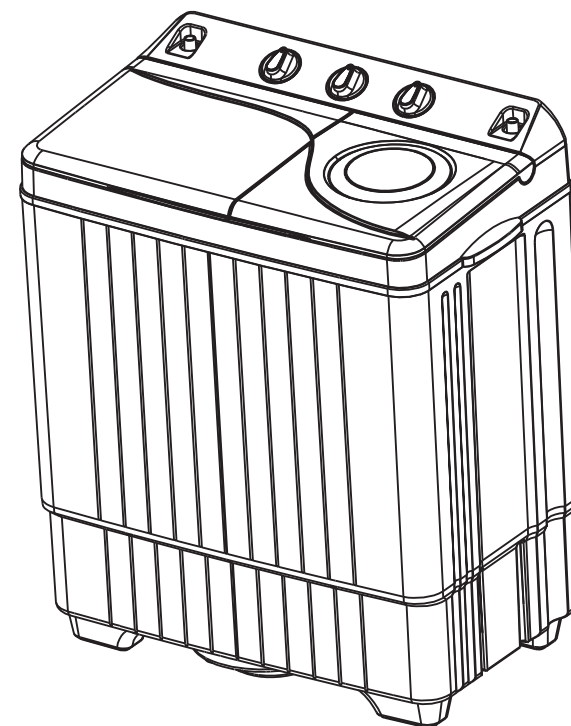

Please give us a chance to make it right and do better !

Contact our friendly customer service department for help first.
Replacements for missing or damaged parts will be shipped ASAP !

US office: Fontana **UK** office: Ipswich **AU** office: Truganina
DE office: Hamburg **FR** office: Saint Vigor d'Ymonville **PL** office: Gdańsk



Contact Us!

Do NOT return this item.

Contact our friendly customer service department for help first.



US: cs.us@costway.com
UK: cs.uk@costway.com
AU: cs.au@costway.com

USER'S MANUAL

Washing Machine



Before You Start

- ⚠ Please read all instructions carefully.
- ⚠ Retain instructions for future reference.
- ⚠ Separate and count all parts and hardware.
- ⚠ Read through each step carefully and follow the proper order.
- ⚠ We recommend that, where possible, all items are assembled near to the area in which they will be placed in use, to avoid moving the product unnecessarily once assembled.
- ⚠ Always place the product on a flat, steady and stable surface.
- ⚠ Keep all small parts and packaging materials for this product away from babies and children as they potentially pose a serious choking hazard.

Parts & Features

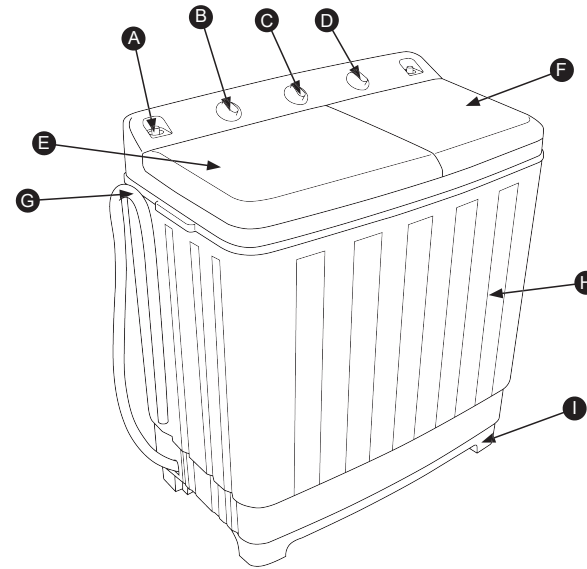

- A. Water Inlet Port
- B. Wash Timer Knob
- C. Wash Selector Knob
- D. Spin Timer Knob
- E. Washer cover
- F. Spin Dryer Cover
- G. Drain Hose
- H. Machine Cabinet
- I. Base

- J. Filter
- K. Washer tub
- L. Pulsator
- M. Spin Dryer lid

- N. Spin Dryer Tub
- O. Spin Dryer Safety Cover
- P. Water Inlet Hose

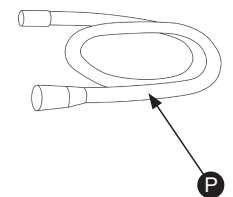
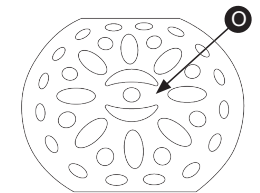
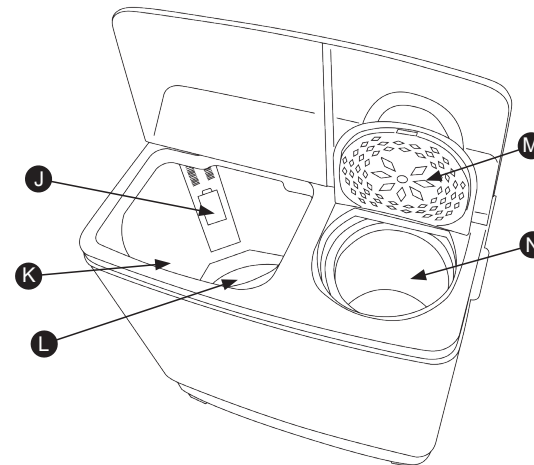

INSTALL

INSTALL IT IN THE FIRM AND SMOOTH PLACE

- ★ Washing machine should be installed in the firm and smooth ground
- ★ Put the washing machine more than 5 cm/2 inch away from the wall



METHOD OF CONNECTING THE INTAKE PIPE

- ★ Put the intake pipe correctly.
- ★ Put the affusion spigot into the affusion hole.

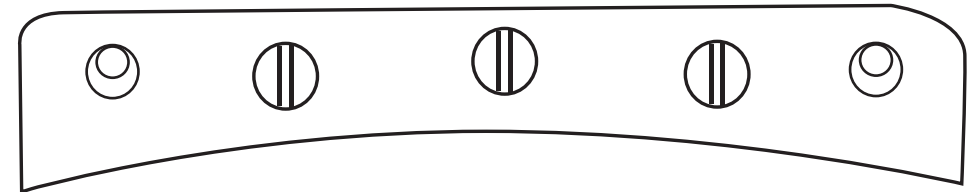
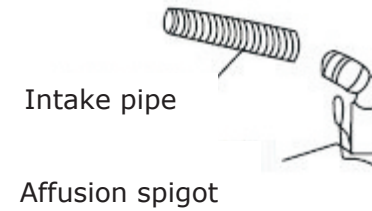

INSTALL IT IN THE FIRM AND SMOOTH PLACE



1. Take out the coin, nails or other things from the garments.



2. Never put chemical reagent into the washing machine



3. Turn clothes inside out before washing



4. Put clothes into laundry bag(not included in the package) before washing

WASHING OPERATION METHOD

Connect the intake pipe with the water spigot

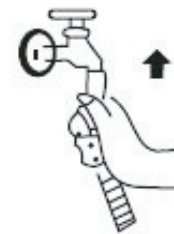

Plug in the power cord

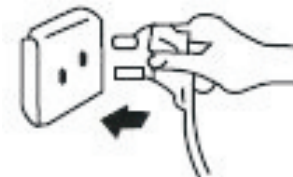

Put down the drain pipe

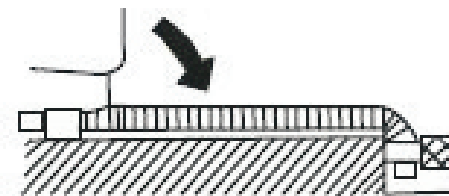

Put garments into the wash tub and put washing powder in.



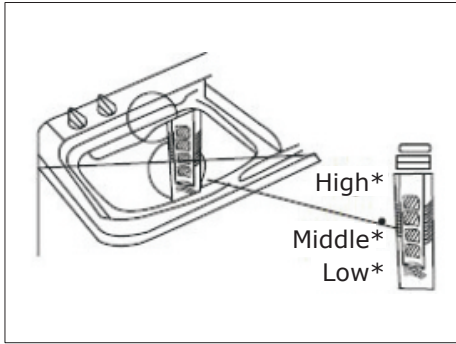

- ★ Choose the water level (high, middle, low) according to the quantity of the garments.
- ★ It's better to choose the middle or high position.

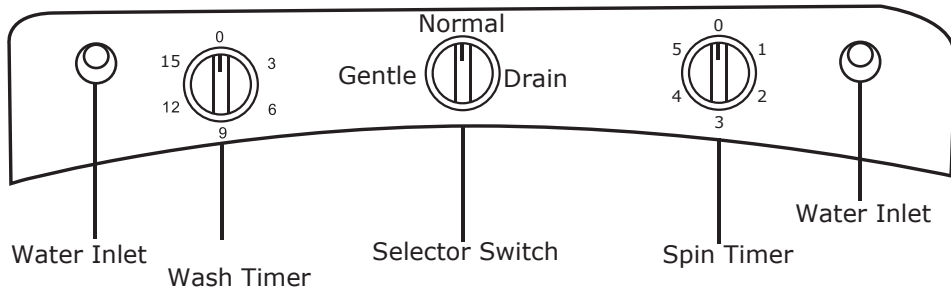

- Choose the washing mode

According to the quantity and material of the garments, turn the selector switch to normal or gentle mode

- Choose the washing time

Set the wash timer after the water reaching the level, then the washing machine begin to work.

Choose the washing mode	Gentle	Normal
Material of the garments	Silk or floss clothing	Linen or very dirty garments
Washing time	3-5min	5-9min 9-15min

Water level	Capacity of washing powder
High	40-57g
Middle	30-48g
Low	25-40g

- **Drain**
- ★ After washing, turn the selector switch to the drain position to drain
- **Choose the spin time**
- ★ Put garments into the spin tub after draining
- ★ Cover the inner and outer spin lid of the spin tub
- ★ Choose spin time to let the washing machine begin to work

Sort of the garments	Spin time
Shirt (synthetic fibre)	1-2min
Underwear	3-5min
Work clothes	5min

DRAIN NOTICE

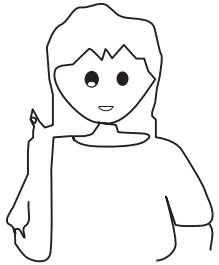

- ★ Put on the outer and inner spin cap on the washing machine.
- ★ Never choose the spin mode while draining. After draining, put the garments into the spin tub to avoid damage.

- ★ Use the safety cover to avoid clothes coming out of the spin tub.
- ★ Never put hands into the spin tub while it is working, especially for children.

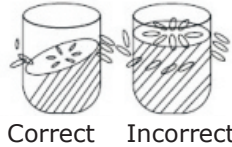

Correct Incorrect

AFTER WASHING

Remove the plug, turn off the spigot and hang up the drain pipe

Clean the spin tub and open the plastic cover to dry the tub

CLEAN THE LINT FILTER

Please clean the lint filter after washing every time.



- ★ Clean the lint filter by putting it in water



- ★ Install the filter at bottom

NOTICE



Don't install it in bathroom or other inclined ground



When you use warm water, make sure it doesn't exceed 122 °F



Don't pour water on the switch



Never use gasoline, alcohol or other organic solvent to clean the machine