



# MAXX ICE

AUTOMATIC

## ICE CUBE MACHINE

User's Manual



Models: MIM452/MIM600/MIM1000

\*Be sure the ice machine has been standing upright for at least 24 hours prior to plug in.

# TABLE OF CONTENTS

|                                                | <b>Page</b> |
|------------------------------------------------|-------------|
| ICE MAKER SAFETY.....                          | 2           |
| IMPORTANT SAFEGUARDS .....                     | 2 - 4       |
| MAJOR FEATURES .....                           | 4           |
| TECHNICAL INFORMATION.....                     | 5           |
| INTRODUCTION .....                             | 5           |
| COMPONENT LOCATIONS .....                      | 6           |
| ICE MAKER INSTALLATION .....                   | 7 - 11      |
| Unpacking .....                                | 7           |
| Location Requirements .....                    | 7 - 8       |
| Typical Installation of Ice Storage Bin .....  | 8 - 9       |
| Electrical Requirements .....                  | 9 - 10      |
| Connecting the Power Supply Line .....         | 10 - 11     |
| Water Supply .....                             | 11          |
| Installation Types.....                        | 11 - 12     |
| OPERATION .....                                | 12 - 14     |
| Final Checklist before Operation .....         | 12          |
| Operating Method .....                         | 12 - 13     |
| How the Machine Makes Ice .....                | 13 - 14     |
| Normal Sounds .....                            | 14          |
| Preparing the Ice Maker for Long Storage ..... | 14          |
| CLEANING AND MAINTENANCE .....                 | 15 - 18     |
| Exterior Cleaning.....                         | 15 - 16     |
| Interior Cleaning .....                        | 16 - 17     |
| Water Distribution Tube Cleaning .....         | 17          |
| Condenser Cleaning .....                       | 18          |
| CONTROL PANEL .....                            | 18 - 19     |
| TROUBLESHOOTING .....                          | 20 - 21     |

**Asbury Foodservice reserves the right to make changes in specifications and design without prior notice.**

**NOTICE: Models MIM452, MIM600, MIM1000 are ice-making units and do not include ice storage bins. If you order a bin, please follow this manual and the manual accompanying the bin regarding installation, adjustment of storage bin feet, cleaning, water drainage, etc.**

# ICE MAKER SAFETY

*Your safety and the safety of others are very important.*

We have provided many important safety messages in this manual and on your appliance. Always read and obey all safety messages.



This is the Safety Alert Symbol. This symbol alerts you to potential hazards that can injure or kill you and others. All safety messages will follow the Safety Alert Symbol and either the words “DANGER”, “WARNING” OR “CAUTION”.



DANGER means that failure to heed this safety statement may result in severe personal injury or death.



WARNING means that failure to heed this safety statement may result in extensive product damage, severe personal injury, or death.



CAUTION means that failure to heed this safety statement may result in minor or moderate personal injury, or property or equipment damage.

All safety messages will alert you to what the potential hazard is, tell you how to reduce the chance of injury, and let you know what would happen if the instructions are not followed.

## IMPORTANT SAFETY INSTRUCTIONS

WARNING: To reduce the risk of fire, electric shock or injury, when using your ice maker, follow these basic precautions:

- Plug into grounded 3-prong outlet
- Do not remove grounding prong
- Do not use an adapter
- Do not use an extension cord
- Disconnect power before cleaning
- Disconnect power before servicing
- Replace all panels before operating
- Use 2 or more people to move and install ice machine

SAVE THESE INSTRUCTIONS

## IMPORTANT SAFEGUARDS



Before the ice maker is used, it must be properly positioned and installed as described in this manual, so read the manual carefully. Maxx Cold strongly recommends that you have a professional install your new machine. The warranty may be affected or voided by an incorrect installation. To reduce the risk of fire, electrical shock or injury when using the ice maker, follow basic precautions, including the following:

## **⚠ DANGER ⚠**

- It is recommended that a separate circuit, serving only your ice maker, be provided. Use receptacles that cannot be turned off by a switch or pull chain.
- Do not connect or disconnect the electric plug when your hands are wet.
- Never unplug the ice maker by pulling on the power cord. Always grip the plug firmly and pull straight out from the outlet.
- Never clean ice maker parts with flammable fluids. Do not store or use gasoline or other flammable vapors and liquids in the vicinity of this or any other appliance. The fumes can create a fire hazard or explosion.
- Before proceeding with cleaning and maintenance operations, make sure the power line of the unit is disconnected and the water line is shut off. (EXCEPTION: When cleaning the machine's ice making and water systems, see pages 16 – 17.)
- Before operating, put all the enclosure panels back into their original place.
- Do not touch the evaporator with your hand when the machine is operating.
- Unplug the ice maker or disconnect power before cleaning or servicing. Failure to do so can result in electrical shock or death.
- Do not attempt to repair or replace any part of your ice maker unless it is specifically recommended in this manual. A qualified technician should do all other servicing.

## **⚠ WARNING**

- Use two or more people to move and install ice maker. Failure to do so can result in back or other injury.
- To ensure proper ventilation for your ice maker, the front of the unit must be completely unobstructed. Choose a well-ventilated area with temperatures above 50°F (10°C) and below 100°F (38°C). This unit **MUST** be installed in an area protected from the elements, such as wind, rain, water spray or drips.
- The ice maker should not be located next to ovens, grills or other sources of high heat.
- The ice maker must be installed with all electrical and water connections in accordance with state and local codes. A standard electrical supply against the nameplate rating (or seeing page 5 “Technical Information”), properly grounded in accordance with the National Electrical Code and local codes and ordinances is required.
- Do not kink or pinch the power supply cord or drain lines between the ice maker and the cabinet.
- The fuse (or circuit breaker) size should be 20 amperes for the ice makers.
- It is important for the ice maker to be well leveled for proper operation. You may need to make several adjustments to level it.
- All installations must be in accordance with local plumbing code requirements.
- Make certain that the hoses are not pinched or kinked or damaged during installation.
- Check for leaks after connection.
- Although the unit has been tested at the factory, due to long-term transit and storage, the first batch of cubes must be discarded.

- Remove the packing materials and clean the ice maker before using.
- Turn on the water supply tap before switching on the ice maker. Never turn off the water supply tap when the ice maker is working.
- Except to take ice from the storage bin, keep the bin door closed in order to reduce ice melting and to promote proper ice formation.
- If the ice maker will not be used for a long time, before the next use it must be thoroughly cleaned. Follow carefully any instructions provided for cleaning or use of sanitizing solution. Do not leave any solution inside the ice maker after cleaning.
- DO NOT touch the condenser fins. The condenser fins are sharp and can be easily damaged.
- DO NOT use solvent-based cleaning agents or abrasives on the interior. These cleaners may transmit taste to the ice cubes, or damage or discolor the interior.
- The ice machine cleaner contains acids. DO NOT use or mix with any other solvent-based cleaner products. Use rubber gloves to protect hands. Carefully read the material safety instructions on the container of the ice machine cleaner.
- Do not use this apparatus for other than its intended purpose.

## **SAVE THESE INSTRUCTIONS**

### **Electrical Connection**

Do not, under any circumstances, cut or remove the third (ground) prong from the power cord. For personal safety, this appliance must be properly grounded. The power cord of this appliance is equipped with a 3-prong grounding plug that mates with a standard 3-prong grounding wall outlet to minimize the possibility of electric shock hazard from the appliance. Have the wall outlet and circuit checked by a qualified electrician to make sure the outlet is properly grounded. When a standard 2-prong wall outlet is encountered, it is your responsibility and obligation to have it replaced with a properly grounded 3-prong wall outlet. The ice maker should always be plugged into its own individual electrical outlet which has a voltage rating that matches the rating label on the appliance. This provides the best performance and also prevents overloading house wiring circuits which could cause a fire hazard from overheated wires. Never unplug your ice maker by pulling on the power cord. Always grip the plug firmly and pull straight out from the outlet. Repair or replace immediately all power cords that have become frayed or otherwise damaged. Do not use a cord that shows cracks or abrasion damage along its length or at either end. When moving the ice maker, be careful not to damage the power cord.

### **Extension Cord**

Because of potential safety hazards under certain conditions, it is strongly recommended that you do NOT use an extension cord with this ice maker.

## **Major Features**

1. Completely automatic operation.
2. The different colors of the LED display indicate various working modes.
3. The fan motor responds to the ambient temperature. If room temperature is low, the motor will stop working to keep the cooling system in good working condition.
4. Ice cube size is adjustable (contact your service representative).
5. Periodically draining water allows for more pure ice and minimum mineral buildup.
6. A sensitive probe and accurate timer enhance the performance of the ice maker.

## Technical Information

| Model                                         | MIM452           | MIM600           | MIM1000          |
|-----------------------------------------------|------------------|------------------|------------------|
| Electrical input                              | 115VAC / 60Hz    | 230VAC / 60Hz    | 230VAC / 60Hz    |
| Power consumption<br>(kW • h /100 lbs of ice) | 7.3              | 6.49             | 5.8              |
| Ice-making/Ice-harvest<br>rated current       | 12.4A/15.3A      | 7.6A/9.85A       | 9.2A/11.3A       |
| Refrigerant                                   | R404A, 24.5 oz.  | R404A, 45.8 oz.  | R404A, 52.9 oz.  |
| High/Low side pressure                        | 350psig/120psig  | 380psig/190psig  | 400psig/190psig  |
| Unit width x depth x<br>height                | 30"x 24"x 20.78" | 30"x 24"x 20.78" | 30"x 24"x 26.58" |
| Unit weight                                   | 130 lbs maximum  | 155 lbs maximum  | 194 lbs maximum  |
| Ice-making capability                         | +340 lbs/day*    | +438 lbs/day*    | +780 lbs/day*    |
| Ice shape                                     | Cube             | Cube             | Cube             |
| Ice cube dimensions                           | 3/4"x 1"x 3/4"   | 3/4"x 1"x 3/4"   | 3/4"x 1"x 3/4"   |

\*Rated in accordance with ARI Standard 810. ( 90°F (32°C)air & 70°F(21°C) water)

The actual quantity of ice produced per day can vary with room and water conditions.

The technical data and performance indices listed above should be used for reference only. They are subject to change.

This product has been tested and certified to NSF standard 12 by NSF International.

## Introduction

Maxx Ice Automatic Commercial Ice Cube machines produce hard, crystal-clear, gourmet cube ice. This user's manual is intended as a resource for persons installing, using and servicing. It contains valuable information on safety and maintenance. Maxx Ice strongly recommends that this manual be kept in a place where it can be accessed when needed. Every Maxx Ice Ice Cube machine is designed and manufactured according to the highest standards of safety and performance. It meets or exceeds the safety standard of UL563 and sanitation standard NSF12.

Asbury Foodservice assumes no liability or responsibility of any kind for products manufactured by Maxx Ice, that have been altered in any way, including the use of any parts and/or other components not specifically approved by Asbury Service Warranty & Parts. Maxx Ice reserves the right to make design changes and/or improvements at any time. Specifications and designs are subject to change without notice.

# Component Locations

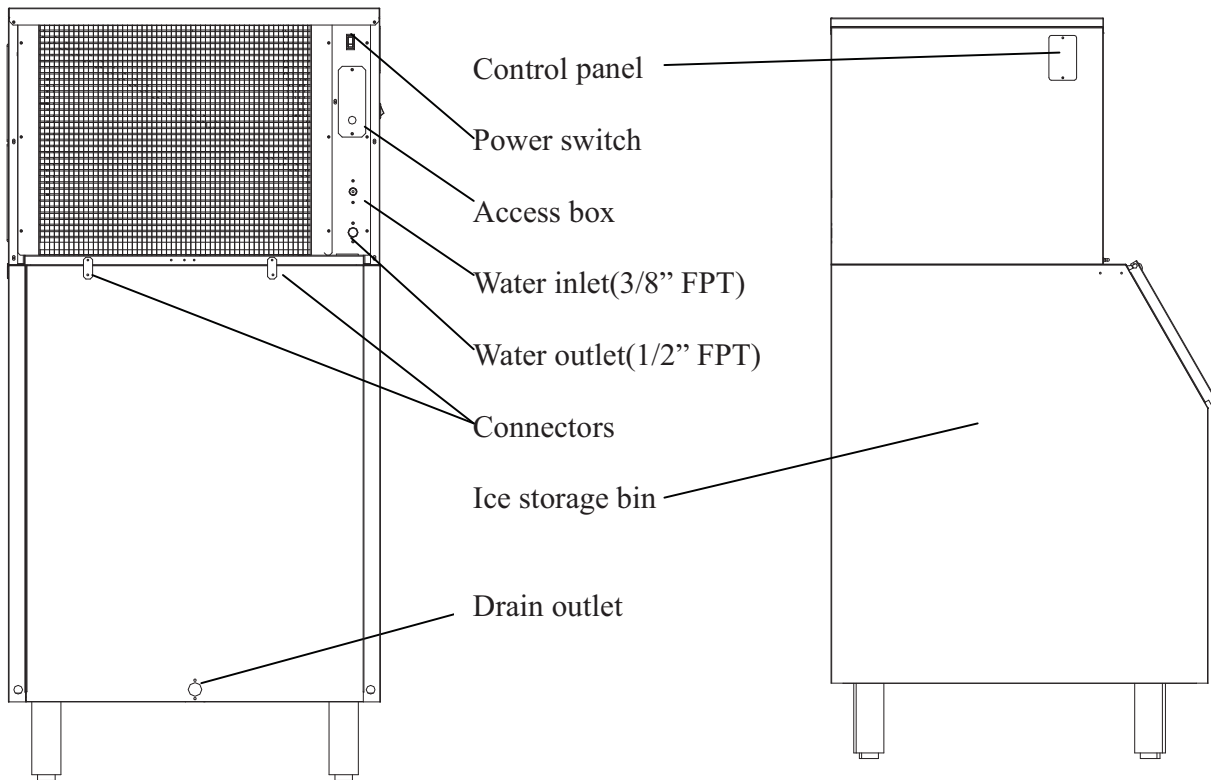
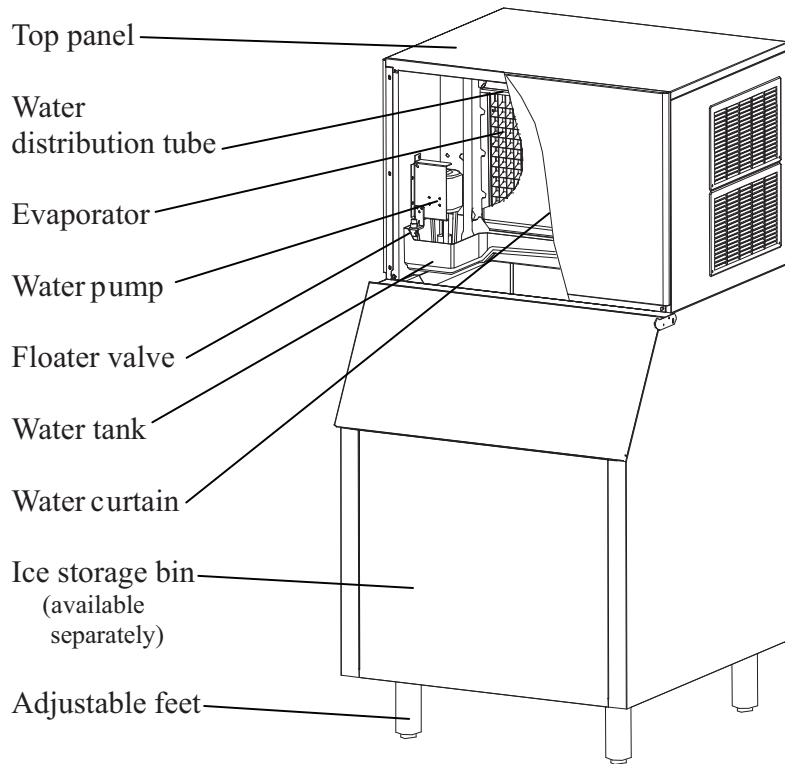

# Ice Maker Installation

## Unpacking

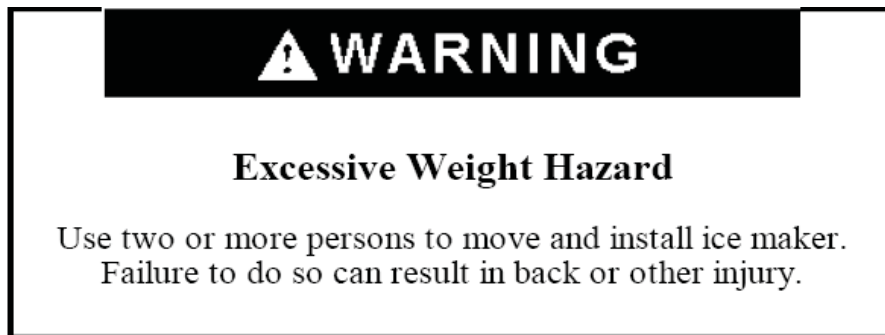

*This unit is an ice maker only. It requires a separate ice storage bin.*

### Remove packaging materials

*NOTE: Do not remove any permanent instruction labels or the data labels on your ice maker.*

Remove tape and glue from your ice maker before using:

- To remove any remaining tape or glue, rub the area briskly with your thumb. Tape or glue residue can also be easily removed by rubbing a small amount of liquid dish soap over the adhesive with your fingers. Wipe with warm water and dry with a soft cloth.
- Do not use sharp instruments, rubbing alcohol, flammable fluids, or abrasive cleaners to remove tape or glue. These products can damage the surface of your ice maker.

### Location Requirements

- This ice maker should be installed by qualified personnel.

### Installation clearance

#### TOP VIEW

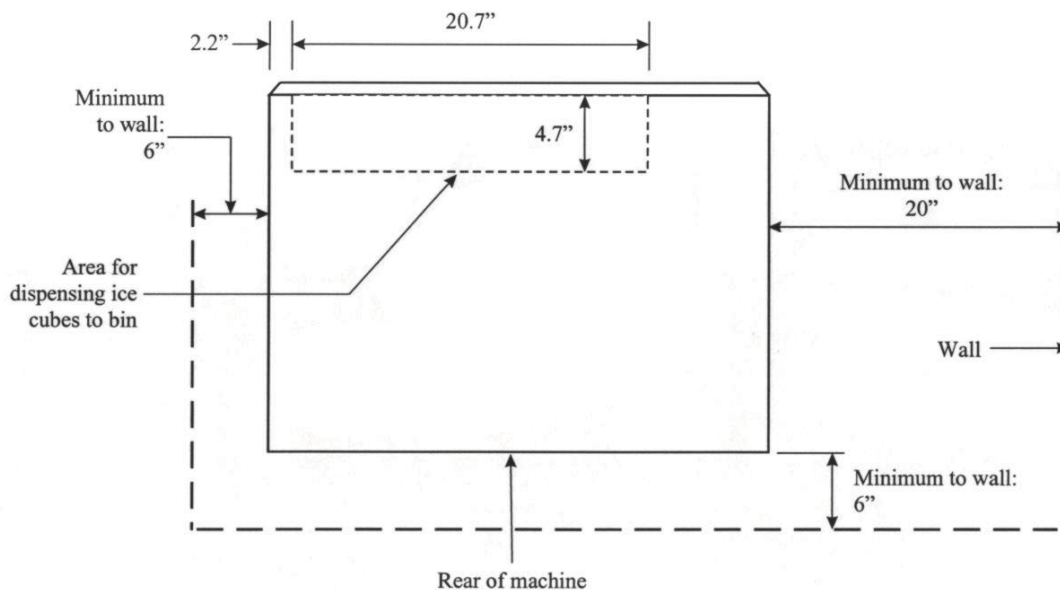



REAR VIEW

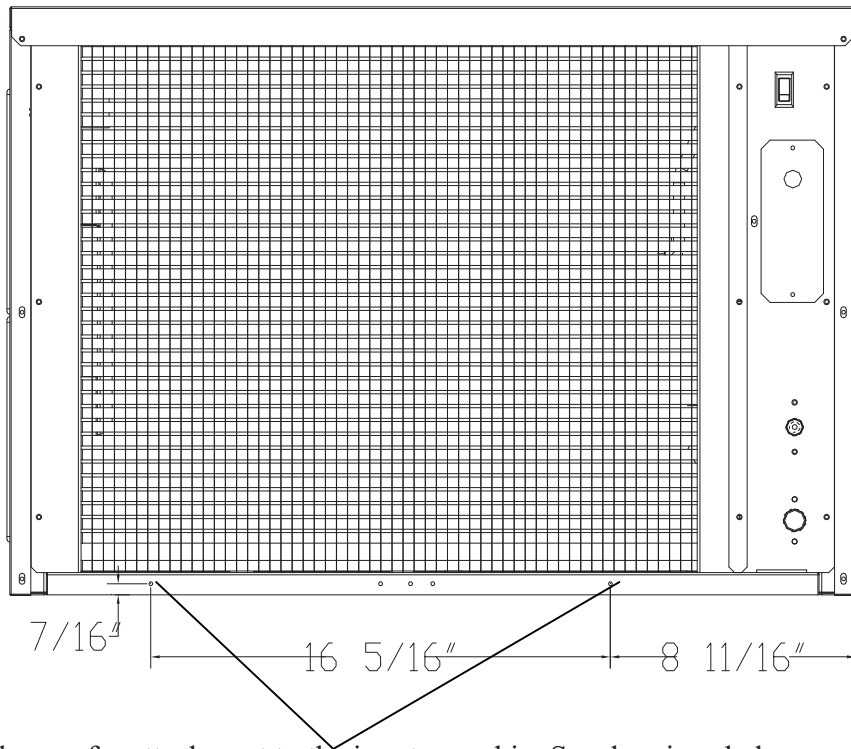

The two holes are for attachment to the ice storage bin. See drawings below.

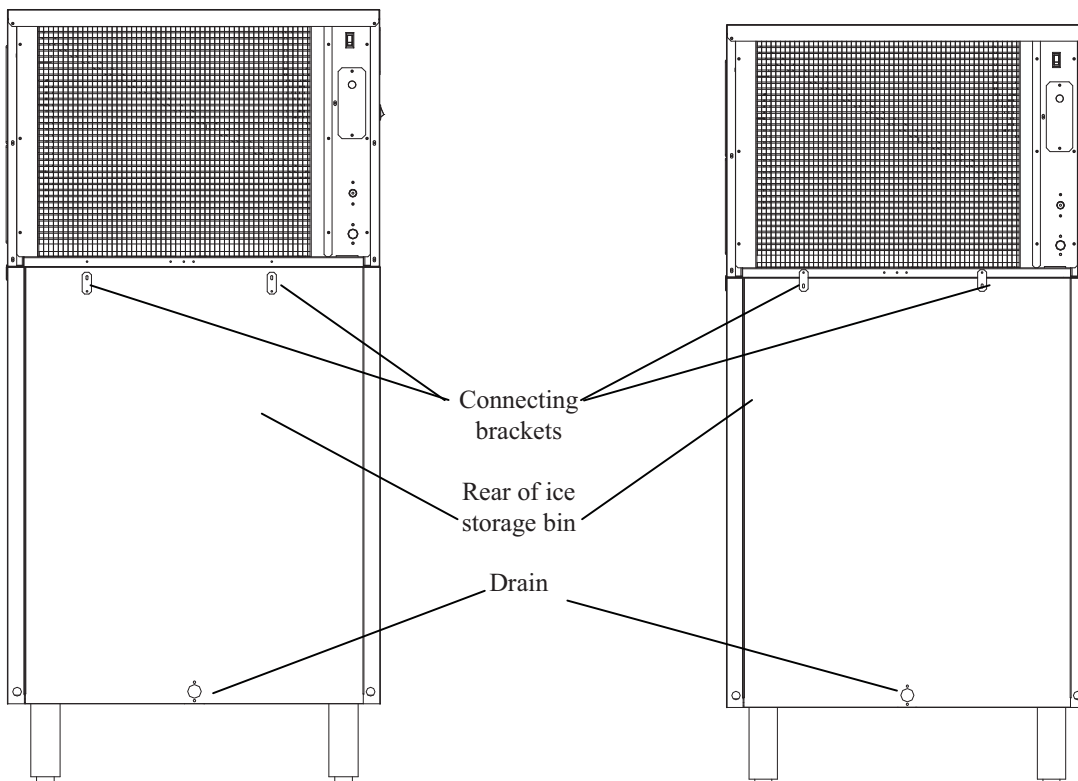

***Typical installation of ice storage bin***

Two connecting brackets are attached to the upper rear edge of the ice storage bin. Turn the brackets up ( $180^\circ$ ) and use two screws to connect the main machine and ice storage bin.



- To ensure proper ventilation for your ice maker, you need keep the front of the unit completely unobstructed.
- Choose a well-ventilated area with temperatures above 50°F (10°C) and below 100°F (38°C). This unit **MUST** be installed in an area protected from the elements, such as wind, rain, water spray or drips.
- The unit should not be located next to ovens, grills or other sources of high heat.
- Installation of the ice maker requires a cold water supply inlet of 3/8" (9.5 mm) soft copper tubing with a shut-off valve.
- The ice maker requires a continuous water supply with a minimum pressure of 15 psig and a static pressure not to exceed 80 psig. The temperature of the water feeding into the ice maker should be between 41°F (5°C) and 90°F (32°C) for proper operation.

|                                                                                                                                                                                                                                                                                                         |
|---------------------------------------------------------------------------------------------------------------------------------------------------------------------------------------------------------------------------------------------------------------------------------------------------------|
|  <b>WARNING</b>                                                                                                                                                                                                        |
| <p>Normal operating ambient temperature should be between 50°F (10°C) and 100°F (38°C). Normal operating water temperature should be between 41°F (5°C) and 90°F (32°C). Operation of the ice maker for extended periods outside of these normal temperature ranges may affect production capacity.</p> |

- In general, it is always a good idea to filter the water. A water filter, if it is of the proper type, can remove taste and odors as well as particles.
- The ice maker must be installed with all electrical and water connections in accordance with state and local codes.
- The ice maker and bin should be located on a firm and level surface. It is important for the ice maker to be perfectly level for proper operation; otherwise water may not flow properly through the evaporator (ice mold). Ice production will be less than expected and operation will be noisy.

The feet of most bins can be rotated to adjust the height if necessary. Follow instructions accompanying the bin you purchase.

### *Electrical Requirements*

|                                                                                                                                                                                                                                                                                                                              |
|------------------------------------------------------------------------------------------------------------------------------------------------------------------------------------------------------------------------------------------------------------------------------------------------------------------------------|
|  <b>DANGER</b>                                                                                                                                         |
|                                                                                                                                                                                                                                           |
| <p><b>Electrical Shock Hazard</b></p> <p>Plug into a grounded 3-prong outlet.<br/>         Never remove the grounding prong from the plug.<br/>         Never use an adapter.<br/>         Never use an extension cord.<br/>         Failure to follow these instructions can result in fire, electrical shock or death.</p> |

- Before you move your ice maker into its final location, be sure you have the proper

electrical connection. Refer to the nameplate rating at the left of the ice machine (or seeing page 5 “Technical Information”) to make sure proper voltage, properly grounded in accordance with National Electrical Code and local codes and ordinances, is required. The ice maker should always be plugged into its own individual electrical outlet. It is recommended that a separate circuit, serving only your ice maker, be provided. Use receptacles that cannot be turned off by a switch or pull chain. The fuse (or circuit breaker) size should be 20 amperes.

### **Recommended grounding method**

For your personal safety, this appliance must be grounded. The power supply cord (not included) must have a 3-prong grounding plug. To minimize possible shock hazard, the cord must be plugged into a mating 3-pronged and grounding-type wall receptacle, grounded in accordance with the National Electrical Code and local codes and ordinances. If a mating wall receptacle is not available, it is the personal responsibility of the customer to have a properly grounded, 3-prong wall receptacle installed by a qualified electrician.

### ***Connecting the power supply line***

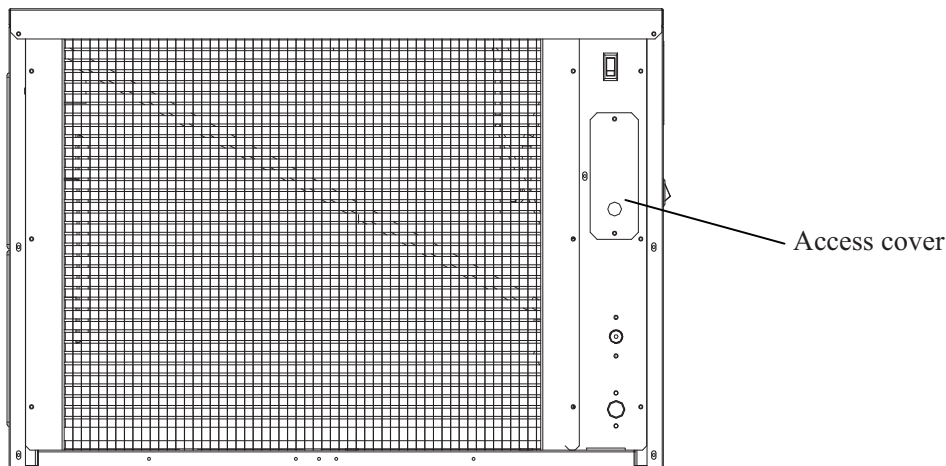

1. Unscrew the two screws holding the access cover and remove the cover. You will find two leads (black and white). See drawing below.

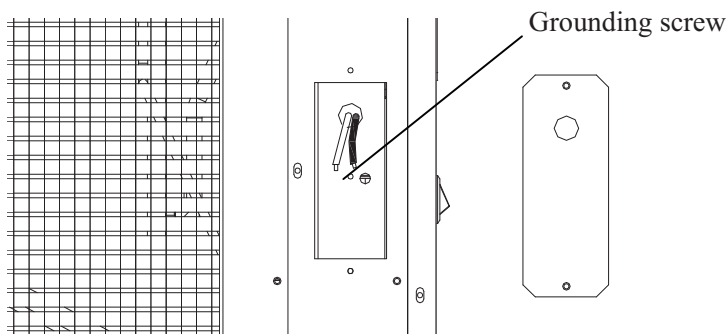

2. Feed a power supply cord (not included) through the access cover and connect it with the two leads. The ground line should be connected to the grounding screw. The two connectors must be insulated. Put the access cover back in place.

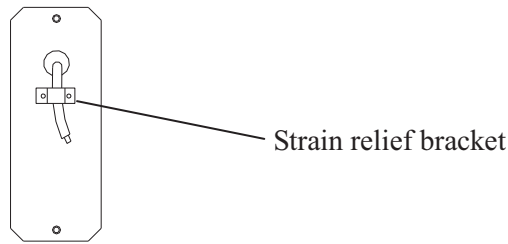

3. You will find a strain relief bracket in the accessory package. Fix the power supply cord below the bracket, as shown in the previous illustration.
4. The other end of the power supply cord should be connected to an outlet that is in accordance with the local electrical code.

***Note: This machine is stackable on any of the machines in this manual. If the machine is to be stacked on top of another machine, a stacking kit will need to be installed. Refer to the installation instructions included with the stacking kit.***

### ***Water Supply***

The water supply should be ready at the point of installation. The water supply pressure should be a minimum of 15 psig with a static pressure not more than 80 psig. *(A wall outlet directly behind the ice maker will make installation easier.)*

### ***IMPORTANT:***

- 1-It is extremely important for proper function and for the purity and taste of the ice to use a water filter when installing the machine. Using a water filter will protect your machine and prevent it from clogs that result from excess minerals in the water.
- 2-All installations must be in accordance with local plumbing code requirements. Professional installation is recommended.
- 3- Water inlet fitting: 3/8" FPT; drain line connection: 1/2" FPT.
- 4- Make certain that you have a proper water supply and a proper drain hose, the hoses are not pinched or kinked or damaged during installation.
- 5- Check for leaks after connection.

**Tools required:** 3/8" open-end wrench, Phillips screwdriver

### **Connecting the water line:**

1. Turn off main water supply.
2. Find a water supply line near the installation location. The distance should be less than the length of the water supply hose.
3. A shut-off valve must be installed to the main water supply.
4. Connect the water supply hose to tap and water inlet valve. Tighten firmly by hand, then one-half turn with wrench.
5. Connect the water drain hose to drain line connection. Tighten firmly by hand, then one-half turn with wrench.
6. Turn on main water supply and tap. Check for water supply connection leaks. Tighten every connection (including connections at the water inlet and drain connections).

### ***Installation Types***

This ice maker has only been designed for free-standing installation. There must be adequate air space around the unit for ventilation purposes. (See page 7.) You must follow the stated instructions for

- a. Electrical requirements
- b. Water supply
- c. Drainage

### **Cleaning before use**

After you remove all tape from the machine, clean the inside of your ice maker and ice storage bin before using them. See “Interior Cleaning” in the *Cleaning and Maintenance* section.

## **Operation**

### ***Final Check List before Operation***

1. Have all packing materials and tape been removed from the interior and exterior of the ice maker?
2. Did you clean the ice storage bin?
3. Have the installation instructions been followed, including connecting the machine to water and electricity?
4. Has the machine been leveled?
5. Is the ice maker in a site where the ambient temperature is between 50° F (10° C) and 100° F (38° C) and the water temperature between 41° F (5° C) and 90° F (32° C) all year round?
6. Has the water supply pressure been checked to ensure a minimum of 15 psig with a static pressure not to exceed 80 psig?
7. Is there a clearance of at least 6” at the rear and 6” at the sides for proper air ventilation?
8. Has the power supply voltage been checked or tested against the nameplate rating? Has proper grounding been installed for the ice maker?
9. Is the ice maker plugged in?
10. Have you turned on the main water supply and the tap?
11. Have you checked for leaks at all water supply connections?

### ***Operating Method***

1. Turn on the water tap; water enters the water tank. Then turn on the power switch; the red indicator LED of the power switch lights.
2. After 3 minutes, the ice maker will automatically proceed to the ice-making stage and the sound of flowing water will be heard.
3. When a batch of ice has been fully formed, it will be harvested into the ice storage bin automatically.
4. When the ice storage bin is full, the sheet of cubes will not fall completely and the

water curtain opens, the micro-switch will be kept open. The machine is in the Bin Full stage.

5. The unit will start making ice again after ice cubes are removed. At the same time, water curtain swings back to hold micro-switch be in operating position.

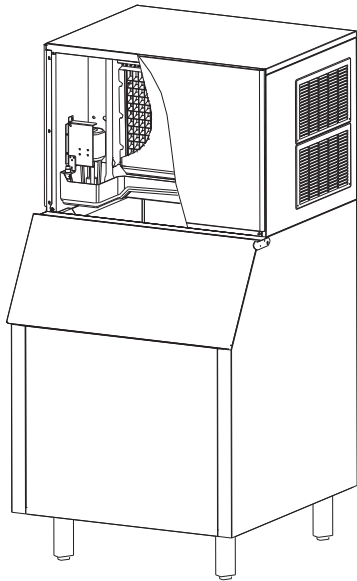

Ice-making stage

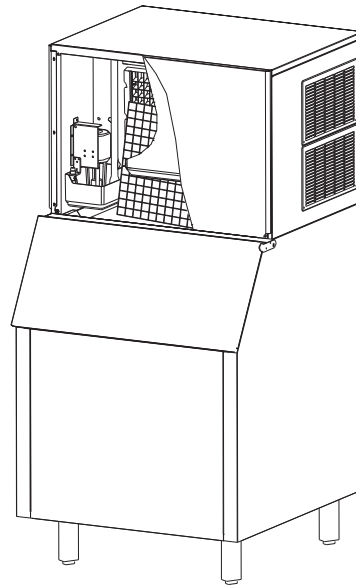

Ice harvest stage

**NOTE:**

- Although the unit has been tested and cleaned at the factory, due to long-term transit and storage, the first batch of cubes must be discarded.
- Never turn off the water supply tap when the ice maker is working.
- Never touch the evaporator when the machine is running.
- Except to take ice from the unit, keep the bin door closed to reduce melting and ensure proper ice formation.

**How the Machine Makes Ice**

Turn the power switch to the ON position. After about 3 minutes the machine will automatically go into the ice-making stage.

There are two distinct cycles: freeze and harvest. During the freeze cycle, water flows to the evaporator surface. In the harvest cycle, the ice is released and water enters the machine. A complete cycle (*freeze cycle and harvest cycle*) takes 15 to 40 minutes, depending on temperature and operating conditions.

**Freeze:** During the freeze cycle the compressor is pumping refrigerant, the fan motor is blowing air, and the water pump is pumping water. When the batch of ice has been fully formed, the ice maker stops the freeze cycle and the harvest cycle start.

**Harvest:** During the harvest cycle, the compressor is still operating and power is supplied to the hot gas valve. Every 10 cycles, the water purge valve opens and allows the water pump to purge the water from the water tank, removing all impurities and sediment. This allows the machine to make clear ice cubes and keep mineral build-up at a minimum. Then the water pump stopped. When the hot gas valve opens, it allows hot gas to go directly to the evaporator. The gas warms the evaporator, causing the cubes to slide off the evaporator and into the storage bin. The freeze cycle will restart when all the cubes drop into the bin.

### How the machine uses water:

The ice maker begins with a fixed charge of water that is contained in the water tank. As the water flows to the freezing evaporator surface, the water freezes and sticks to the ice cube molds. During the ice-making process, fresh water enters the water tank continuously as the water from the tank freezes continuously on the evaporator.

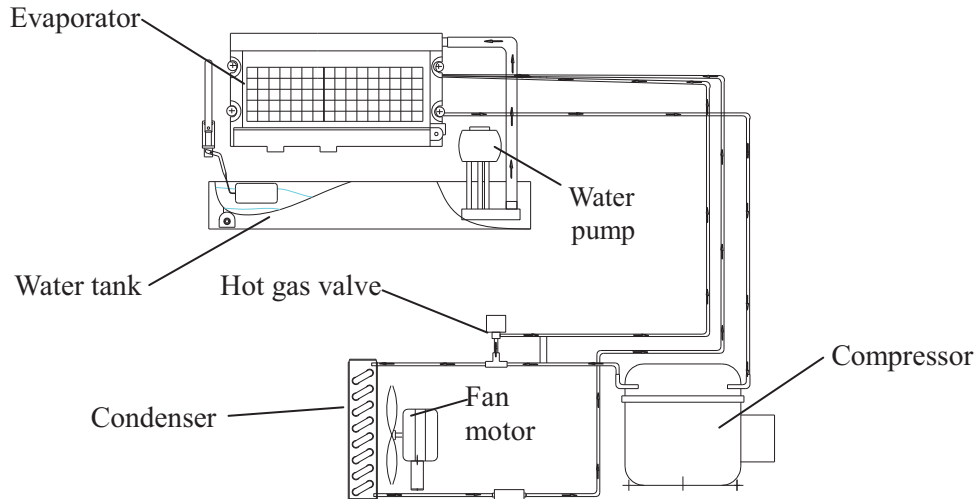

### Normal Sounds

Your new ice maker may make sounds that are unfamiliar to you. Most of the new sounds are normal. Hard surfaces like the floor and walls can amplify the sounds. The following describes the kinds of sounds that might be new to you and what may be causing them.

- Rattling noises may come from the flow of the refrigerant or the water line. Items stored on the top of the ice maker can also make noises.
- The high-efficiency compressor may make a pulsating or high-pitched sound.
- Running water may make a splashing sound.
- You may hear air being forced over the condenser by the condenser fan.
- During the harvest cycle, you may hear the sound of ice cubes falling into the ice storage bin.

### Preparing the Ice Maker for Long Storage

If the ice maker will not be used for a long time, or it is to be moved to another place, it will be necessary to drain water from the system.

1. Shut off the water supply at the main water source.
2. Disconnect the water supply pipe from the water inlet.
3. Depress the clean button and hold over six seconds, the machine will go into the draining mode automatically, with harvest and ice-making indicators blinking, till the water flush down the drain completely. The harvest indicator and ice-making indicator LEDs will be on. The drain process complete.
4. Shut off the power supply at the main electrical power source.
5. Dry the water tank.
6. Remove all ice cubes from the ice storage bin and dry it.
7. Keep the door opening to allow for ventilation and to prevent mold and mildew.
8. Leave the water supply pipe and power cord disconnected until ready to reuse.

## Cleaning and Maintenance

### CAUTION

If the ice maker is left unused for a long time, before the next use it must be thoroughly cleaned. Follow carefully any instructions provided for cleaning or use of sanitizing solution. Do not leave any solution inside the ice maker after cleaning.

Periodic cleaning and proper maintenance will ensure efficiency, top performance, and long life. The maintenance intervals listed are based on normal conditions. You may want to shorten the intervals if you have pets or there are other special considerations.

#### **What shouldn't be done?**

Never keep anything in the ice storage bin other than ice: objects like wine and beer bottles are unsanitary, and the labels may slip off and block the drain.

#### **What should be kept clean?**

There are 5 things to keep clean:

1. The exterior
2. The interior
3. Water distribution tube
4. The ice-making system
5. Condenser fins

### ⚠ WARNING

Before proceeding with cleaning and maintenance operations, make sure the power line of the unit is disconnected and the water line is shut off. (EXCEPTION: Cleaning of ice-making system)

#### ***Exterior Cleaning***

Commercial grades of stainless steel are susceptible to rusting if not properly maintained. It is important that you properly care for the stainless steel surfaces of your ice machine and bin to avoid the possibility of rust or corrosion. Use the following recommended guidelines for keeping your stainless steel looking like new:

1. Clean the stainless steel thoroughly once a week. Clean frequently to avoid build-up of hard, stubborn stains. Also, hard water stains left to sit can weaken the steel's corrosion resistance and lead to rust. Use a nonabrasive cloth or sponge, working with, not across, the grain.
2. Don't use abrasive tools to clean the steel surface. Do not use steel wool, abrasive sponge pads, wire brushes or scrapers to clean the steel. Such tools can break through the "passivation" layer - the thin layer on the surface of stainless steel that protects it from corrosion.



3. Don't use cleaners that use chlorine or chlorides. Do not use chlorine bleach or products like Comet to clean the steel. Chlorides can also break down the surface layer and can cause rusting.

4. Rinse with clean water. If chlorinated cleansers are used, you must thoroughly rinse the surface with clean water and wipe dry immediately.

5. Use the correct cleaning agent. The table below lists the recommended cleaning agents for common stainless steel cleaning problems:

| <b>Cleaning Activity</b>            | <b>Cleaning Agent</b>                                                                                | <b>Method of Application</b>                                                                    |
|-------------------------------------|------------------------------------------------------------------------------------------------------|-------------------------------------------------------------------------------------------------|
| Routine Cleaning                    | Soap, Ammonia, or detergent with water, for stainless steel, use an approved stainless steel cleaner | Apply with a clean cloth or sponge. Rinse with clean water and wipe dry                         |
| Removing grease or fatty acids      | Approved degreaser or oven cleaners                                                                  | Apply generously, allow to stand for 15-20 minutes. Rinse with clean water. Repeat as required. |
| Removing hard water spots and scale | Vinegar                                                                                              | Swab or wipe with clean cloth. Rinse with clean water and dry                                   |

### ***Interior Cleaning***

It is the USER'S RESPONSIBILITY to see that the unit is properly maintained. It is always preferable and less costly in the long run, to avoid possible down time by keeping it clean and adjusted as needed; and by replacing worn components before they can cause failure. The following is a list of recommended maintenance that will help keep the machine running with a minimum of problems.

Maintenance and Cleaning should be scheduled at a minimum of twice per year.

Note: Electrical power will be ON when performing the following cleaning instructions.

1. Remove ice machine front panel.
2. Make sure all ice is off evaporator. If ice is being made, initiate harvest or wait for cycle completion, then turn machine off at the power switch.
3. Remove all ice cubes from the storage bin.
4. Keep the ice maker connected to the water supply. Pour 8 oz. of Nickel-Safe Ice Maker Cleaner Solution into the water tank.
5. Turn on the power switch. Within 3 minutes press the **Clean** button. The machine will go into the cleaning mode automatically.
6. The ice-making system cleaning cycle will continue for 30 minutes unless you press the power switch (you can press the power switch to stop the cleaning cycle any time during the 30 minutes).
7. Press the **Clean** button for 6 seconds and the water will be purged and the green and yellow LEDs will be blinking together. Allow to drain for at least two minutes and press the "OFF" button.
8. Remove the splash curtain and inspect the evaporator and water spillway to ensure all mineral residue has been removed. If necessary, wipe the evaporator, spillway and other water transport surfaces with a clean soft cloth to remove any remaining residue. If necessary, remove the water distribution tube, disassemble and clean with a bottlebrush. Reassemble all components and repeat steps 4 through 7 as required to remove residue

9. Repeat step 6-7 WITHOUT ADDING ICE MACHINE CLEANER above three times to rinse the ice-making system thoroughly. This will complete ice-making system cleaning.
10. Prepare 1½ to 2 gallons (5.7 to 7.5 liters) of approved (EPA/FDA) sodium hypochlorite food equipment sanitizer to form a solution with 100 to 200 max. ppm free chlorine yield.
11. Add enough sanitizing solution to fill the water trough to overflowing and begin the cleaning cycle as indicated in 5 (without adding the CLEANER), and allow circulation to occur for 5 minutes and inspect all disassembled fittings for leaks. During this time, wipe down all other ice machine splash areas, plus the interior surfaces of the bin, deflector and door with the remaining sanitizing solution. Inspect to insure that all functional parts, fasteners, thermostat bulbs (if used), etc. are in the correct position.
12. Press the Clean button for 6 seconds and the water will be purged and the green and yellow LEDs will be blinking together. Allow to drain until sanitizer has been flushed down the drain and continue to purge to the diluted sanitizing solution for another 1 to 2 minutes. Then press the controller to “OFF”
13. Turn the machine ON and replace the front panel.
14. Discard the first two ice harvests. DO NOT USE any ice produced from the cleaning solution.

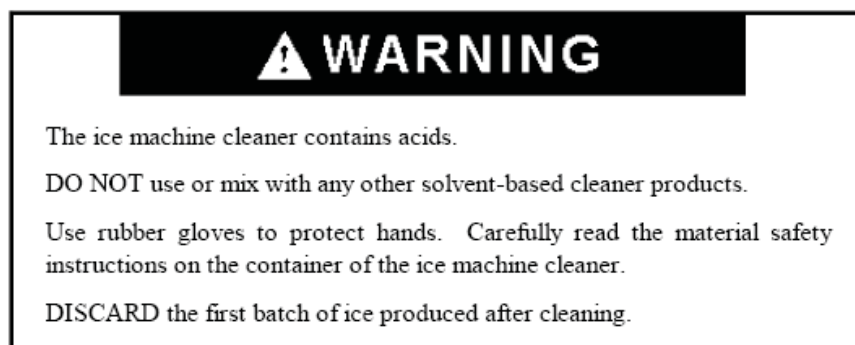
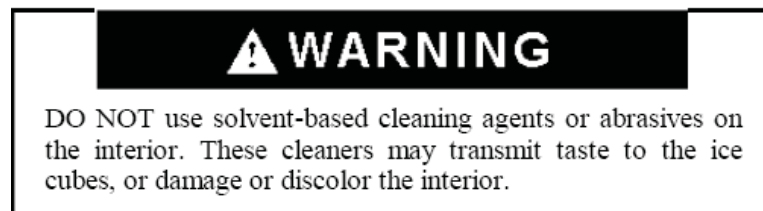

### ***Water Distribution Tube Cleaning***

If you find that the ice cubes are incompletely formed or the output of ice cubes is low, the water distribution tube may be blocked. To correct this problem, first set the power switch to OFF. Unscrew the six screws holding the top panel and remove the panel. You will see the water distribution tube. Rotate the water distribution tube so that the holes in it are facing up. Using a toothpick or similar tool, dredge the holes, then rotate the water distribution tube back to its original position. If the tube is badly blocked, clean it as follows:

1. Shut off the water and power supplies.
2. Disconnect the water hose from the distribution tube.
3. Lift one side, remove the distribution tube.
4. With a brush, clean the tube with a diluted solution of warm water and a mild detergent such as dishwashing liquid. After removing the dirt and lint from the surface, rinse the tube with clean water.
5. Replace the distribution tube.
6. Reconnect the water supply and power supply lines.
7. Re-attach the top panel.

## Condenser Cleaning

1. See drawing below.

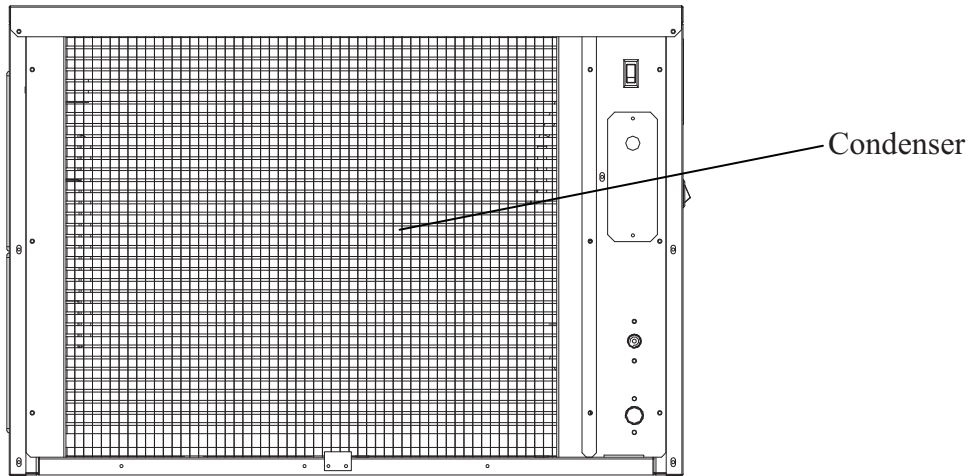

2. The air cooled condenser should be vacuumed once or twice per year to remove any lint that may have been drawn into it. using a tool that seems like a probe to remove any lint from the condenser fins.

## Control Panel (at the left side of the machine)

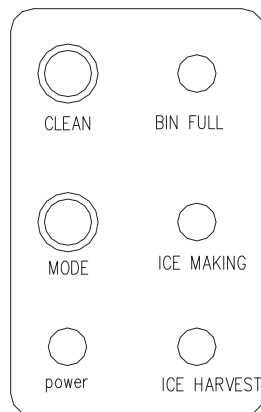

You will find the control panel in the side of the machine. This panel includes two button and four indicator LEDs.

### Operation of the control panel:

1. When the unit is plugged in and the power switch is turned on, the power indicator and the other three indicator lights are all on.
2. After three minutes for water inlet, the ice maker will start to make ice automatically. Only the power and ice-making indicators will be on.
3. During harvest, the harvest indicator light is on and ice-making indicator off. When the ice storage bin is full, only the ice-full indicator and power indicator are on.
4. If the Clean button is pressed during the ice-making or harvest mode, it will be ignored. The ice-making or harvest will continue.
5. When you want to clean the machine, turn off the power switch first, then turn it on again. Press the Clean button within 3 minutes and the ice maker will start the cleaning mode, with harvest and ice-making indicators blinking. After 30 minutes, the cleaning mode stops and the harvest indicator and ice-making indicators are on steady. If you want to restart the ice-making process after cleaning, turn off the power switch first, then turn on

the power switch again and the machine will automatically go into the ice-making process.

6. If you want to interrupt the cleaning mode before it is finished, do not press the Clean button again. Instead, turn the power switch off. This stops the cleaning cycle.
7. If the machine is on but only the power indicator light is lit, this may indicate that not enough water is reaching the system, that the water pump is not functioning, or some similar problem. First check the level in the water tank, then examine the water pump, etc.
8. If the unit is connected to the power supply but no visual indicator lights up when the power switch is turned on, the fuse in the control panel box may need to be replaced.
1. Bin Full (white) LED: Bin Full indicator light When this LED is on, it indicates that the ice level in the bin is high enough to hold the water curtain open, the microswitch is open, or there is something obstructing the closing of the water curtain. The unit will stop working. When ice cubes are removed from the ice storage bin, clearing the ice-full probe, the white LED will flash for 3 minutes. Then the unit will restart and return to the ice-making mode.
2. Ice Making (Green) LED: Ice Making indicator light When this LED is on, the unit is in the ice-making mode.
3. Ice Harvest (Yellow) LED: Ice Harvest indicator light When this LED is on, the unit is working in the ice harvest mode.
4. Power (White) LED: Power indicator light When the main power switch that is located on the left side of the unit is turned on, The power indicator LED is on ,the unit starts working after 3 minutes.
5. Mode button: This button is mainly for service. When it is pressed, the ice making mode changes to ice harvest mode or vice versa. The mode is indicated by the status of the green or yellow LEDs.
6. Clean button If you press the Clean button within three minutes after the power has been turned on, the ice maker will enter the cleaning mode. If press the Clean button and hold it for more than six seconds, the machine will enter the draining mode. The green and yellow LEDs will be blinking together.

#### **Ice Size Adjustment Guide:**

1. Press and hold the “Clean” button and the “Mode” button together for at least 3 seconds. The unit will enter the Ice Size Adjustment mode. The “ICE” LED (green) will be blinking continuously during the ice size adjustment.
2. While in the Ice Size Adjustment mode, press the “Clean” button or the “Mode” button for the desired ice size.

#### **Smaller ice setting:**

By pressing the “Clean” button, you can decrease the size of the ice cubes. The “FULL” LED (red) will flash as you lower the ice size and will finally be blinking at the setting of smallest ice size.

#### **Larger ice setting:**

By pressing the “Mode” button, you can increase the size of the ice cubes. The “HARVEST” LED (yellow) will flash as the larger size is set and will blink when the setting of largest ice size has been reached.

*After 10 seconds without any operation, the unit will automatically memorize the current state and return to the previous mode.*

**NOTE:** If during the ice size adjustment, the “BIN FULL”, “ICE” and “HARVEST” LEDs blink all at once, this indicates that the unit is in the default factory setting of the ice size adjustment.

**IMPORTANT:** .Avoid letting water contact the control box

## Troubleshooting

### *Before Calling for Service*

If the unit appears to be malfunctioning, read through the OPERATION section of this manual first. If the problem persists, check the Troubleshooting Guide below and on the following page. The problem could be something very simple that can be solved without a service call.

### Troubleshooting Guide

| <b>Problem</b>                                                                 | <b>Possible cause</b>                                                                                | <b>Probable correction</b>                                                                         |
|--------------------------------------------------------------------------------|------------------------------------------------------------------------------------------------------|----------------------------------------------------------------------------------------------------|
| <b>The machine doesn't operate.</b>                                            | The ice maker is unplugged.                                                                          | Plug the ice maker in.                                                                             |
|                                                                                | The fuse is blown.                                                                                   | Replace fuse. If it happens again, call for service to check for a short circuit in the ice maker. |
|                                                                                | The ice maker power switch is OFF.                                                                   | Turn the ice maker power switch ON.                                                                |
|                                                                                | The ice storage bin is full of ice.                                                                  | Remove some ice. Make sure the water curtain and micro-switch are closed.                          |
| <b>Water doesn't feed in after the ice maker starts.</b>                       | The water tap is turned off.                                                                         | Turn on the water supply tap.                                                                      |
|                                                                                | The water supply line is not connected properly.                                                     | Reconnect the water supply line.                                                                   |
| <b>Machine makes ice cubes, but ice storage bin does not fill up with ice.</b> | Condenser may be dirty.                                                                              | Clean the condenser air filter.                                                                    |
|                                                                                | The air flow to the ice maker may be obstructed.                                                     | Check the installation.                                                                            |
|                                                                                | The ambient and water temperatures are high, or the machine is near some heat source.                | Check the installation.                                                                            |
| <b>Water is leaking from the unit.</b>                                         | A few water drops fall to the floor when you open the door to take out ice from the ice storage bin. | Normal condensation on the door or some water together with ice. Take care when you take out ice.  |
|                                                                                | Water supply connection leaking.                                                                     | Tighten fitting. See "Connecting the water line".                                                  |

| <b>Problem</b>                                              | <b>Possible cause</b>                                        | <b>Probable correction</b>                                                                                     |
|-------------------------------------------------------------|--------------------------------------------------------------|----------------------------------------------------------------------------------------------------------------|
| <b>Cube are partially formed or are white at the bottom</b> | Not enough water in the water trough.                        | Check if the water supply pressure is below 15 psig.                                                           |
|                                                             |                                                              | Check water supply; filter may be restricted.                                                                  |
|                                                             |                                                              | Check for a water leak at the water trough.                                                                    |
| <b>Noise during operation.</b>                              | The feet are not leveled and locked                          | Level and lock the feet. See “Leveling the Ice Maker”.                                                         |
|                                                             | Certain sounds are normal.                                   | See “Normal Sounds”.                                                                                           |
| <b>The ice maker stops suddenly while making ice.</b>       | The electricity is off.                                      | Reconnect the power supply line.                                                                               |
|                                                             | The room temperature is out of the stated temperature range. | Cut off the electricity; Let the ice maker stop working until the temperature returns within the stated range. |
|                                                             | The ice storage bin is full of ice.                          | Remove some ice cubes; Make sure the water curtain and micro-switch are close.                                 |
| <b>The body of the ice maker is electrified.</b>            | The grounding line isn’t in the socket.                      | Use a socket meeting the required electrical standard.                                                         |
| <b>Scaling occurs frequently inside the machine.</b>        | The hardness of the water is too high.                       | Use a water-softening device installed in front of the water inlet.                                            |



Tested and certified to NSF standard 12 by NSF International



**MAXXICE**

**3355 Enterprise Avenue, Suite 160 Weston, Florida 33331**

**Tel: 954-202-7419 - Fax: 954-202-7337**