



Hodedah

www.hodedah.com
support@hodedah.com

ASSEMBLY INSTRUCTIONS

HI D 8600 (2 DOOR WARDROBE)

~ Before assembly, please read the instructions ~ ~ Follow these steps to assemble the 2 DOOR WARDROBE ~
~ Keep these instructions for future reference ~

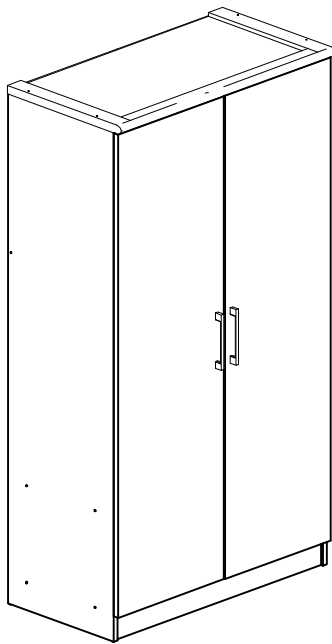

FRONT VIEW

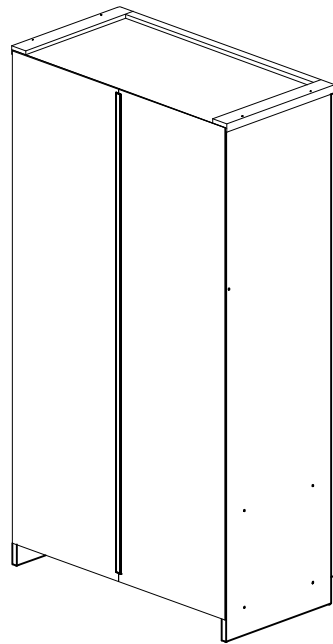

BACK VIEW



THIS INSTRUCTION BOOKLET CONTAINS IMPORTANT INFORMATION ABOUT ASSEMBLY AND SAFETY. PLEASE READ AND KEEP FOR FUTURE REFERENCE.



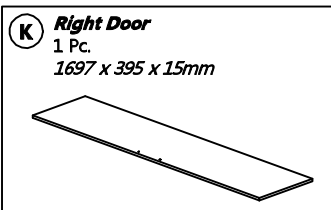
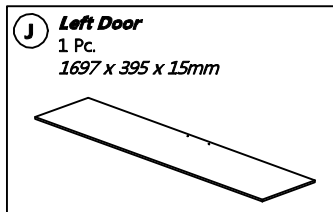
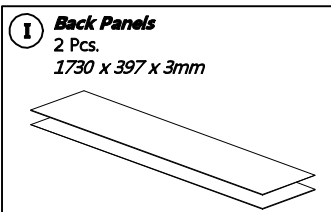
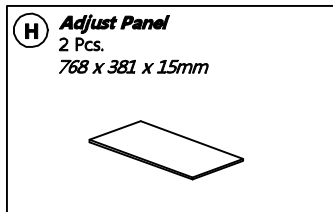
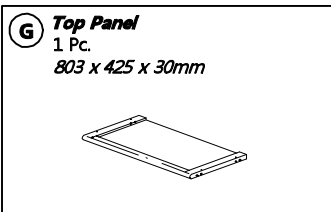
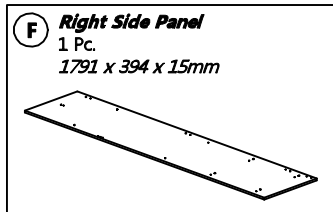
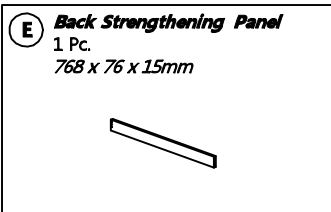
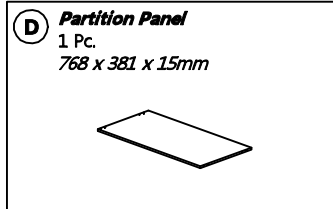
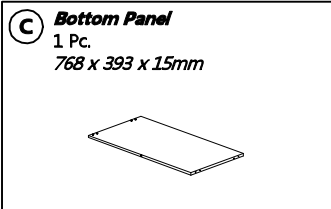
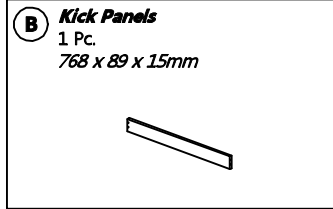
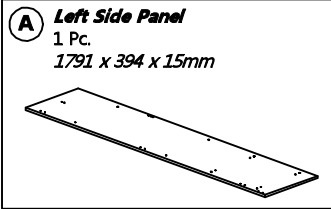



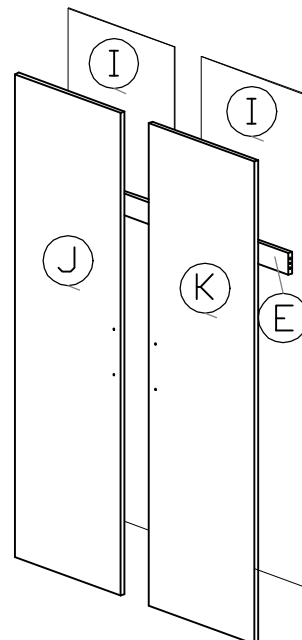
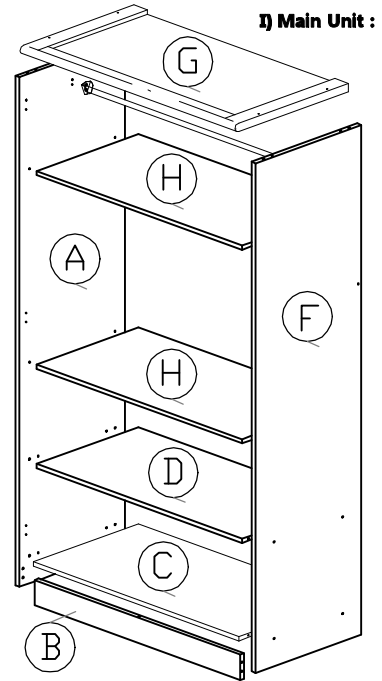



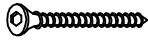

Parts

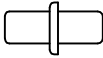

The parts of the product are packed in one box.
There are inner box(es) or package(s) that included components and accessories required to complete the assembly

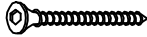

Hardware And Accessories

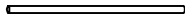
<p>1 Screw M6 x 40mm 10 Pcs.</p> 	<p>2 Screw M3.5 x 14mm 28 Pcs.</p>  <p>* For # 5 HINGERS</p>	<p>3 Nail 60 Pcs.</p> 	<p>4 Pvc Dowel 21 Pcs.</p> 	<p>5 HINGES 6 Pcs.</p> 
<p>6 SHELF SUPPORT 12 Pcs.</p> 	<p>7 Protection Nail 4 Pcs.</p> 	<p>8 SCREW M 10 X 1/2 MM 12 Pcs.</p> 	<p>9 Handle 2 Pcs.</p>  <p>SCREW M4 X 20mm 4Pcs</p>	<p>10 Allen Key 1 Pc.</p> 
<p>11 V-BRACKET 2 Pcs.</p> 	<p>12 Screw M6 x 50mm 4 Pcs.</p> 	<p>13 Pvc Cap 14 Pcs.</p> 	<p>14 H-PROFILE 1 Pc.</p> 	<p>15 IRON TUBE 1 Pc.</p> 





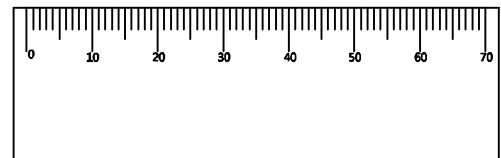

IMPORTANT

Check the measure of the bolts on the scale below or with a measuring tape before applying them in the parts

Observe correctly the application and the position of each bolt accessory, as the step-by-step instructions, before applying them in the parts.



Required Or Recommended Tools

<p>Sample Screwdriver</p> 	<p>Sample Hammer</p> 	<p>Sample Measuring Tape</p> 	<p>Sample Electric Screwdriver</p> 
---	--	--	--



IMPORTANT!

The required or recommended tools for assembly are not supplied with the product.



Hodedah

www.hodedah.com
support@hodedah.com

- This product contains small components, please ensure that they are kept away from small children.
- THIS INSTRUCTION BOOKLET CONTAINS **IMPORTANT** SAFETY INFORMATION. PLEASE READ AND KEEP FOR FUTURE REFERENCE.



DO NOT RETURN PRODUCT TO THE STORE.

If a part is missing or damaged, email our customer service. We will gladly ship your replacement parts **FREE** of charge.

Need Parts or Assistance?

email us at

support@hodedah.com

For prompt, reliable service; please have your assembly manual ready.



Hodedah
www.hodedah.com
support@hodedah.com

Thank you for purchasing from Hodedah

**To learn more about hodedah and our products visit
www.hodedah.com**

READ BEFORE BEGINNING ASSEMBLY

- Read each step carefully. It is very important that each step of instruction is performed in the correct order. If these steps are not followed in sequence, assembly difficulties will occur.
- Make sure all parts are included. Most parts are labelled or stamped on the raw edge.
- Work in spacious area, preferably on a carpet, near the place the unit will be used.
- Do not use power tools to assemble your furniture. Power tools may strip or damage the parts.

HELPFUL HINTS

- Call us if you need assistance.
- Move your new furniture carefully, with two people lift and carry the unit to it's new location.
- Never push, drag or pull your furniture (especially on carpet).

Warranty Information

Hodedah warrants this product to be free from defects in material and workmanship agrees to remedy any such defect. This warranty covers one year from the date of original purchase. This is solely limited to be repair or replacement of defective parts and no assembly labor is included.

This warranty does not apply to any product which has been improperly assembled, subjected to misuse or abuse or which has been altered or repaired in any way.

To obtain warranty service, purchaser must present original bill of sale. Components repaired or replaced warranted through the remainder of the original warranty period only. The defective components will be repaired or replaced without charge, subject to the terms and conditions described above.

For help with assembly, identifying parts, product information or to order parts, please contact us:

Call us at:
718-456-0505
Monday-Friday
9:00am-5:00pm

Visit our website:
www.hodedah.com

Pre - Assembly

Insert the PVC dowels ④ to top edge of panel A and F's non-thru holes, using hammer to tap them in.

Tighten V-Bracket ⑪ on panel A and F as shown by using 2 screws ②.

Insert 4 shelf supports ⑥ into panel A and F's non thru holes as shown.

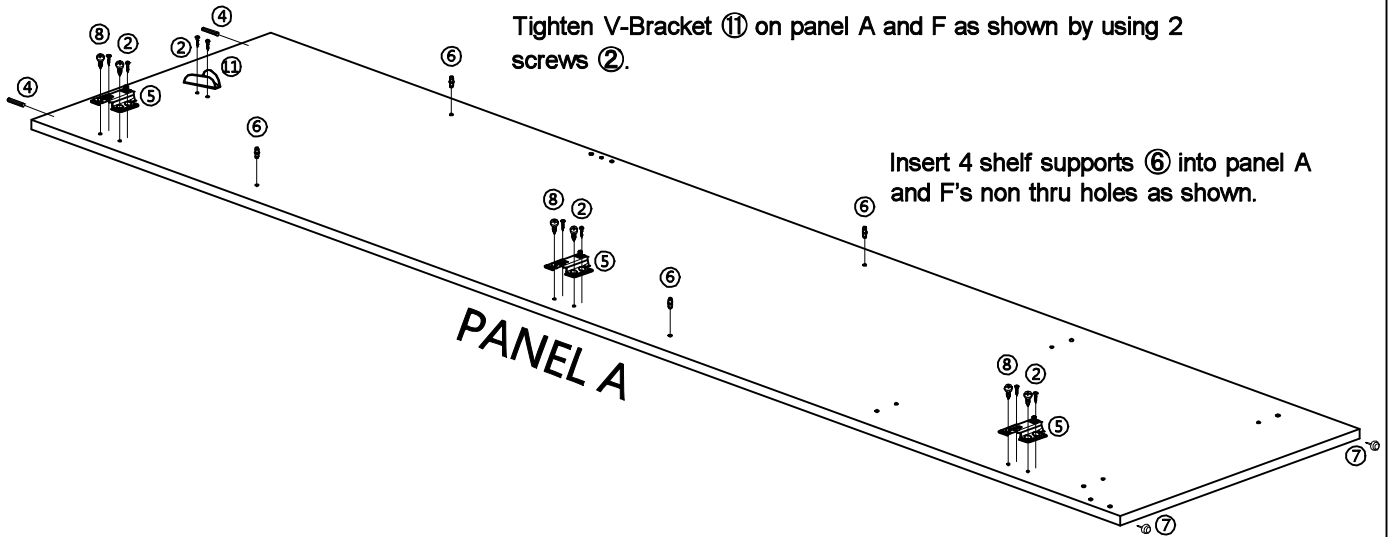

Nail Protection Nail ⑦, provided with hammer onto the bottom edge of panel A and F as shown.

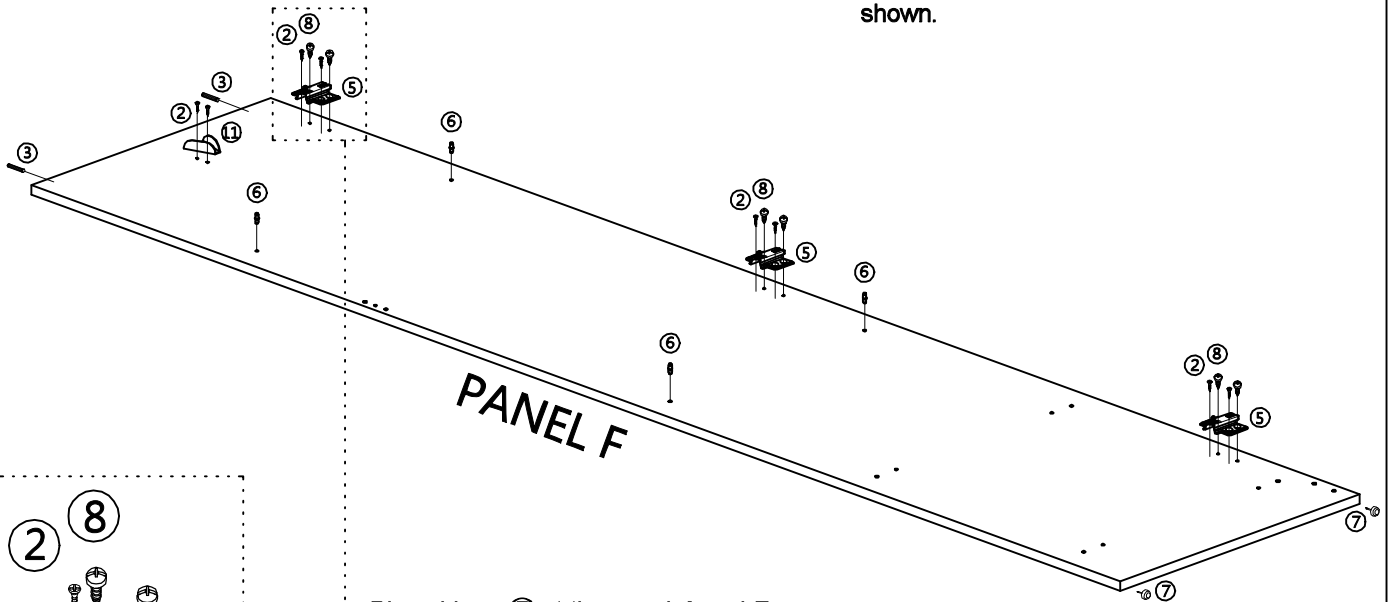

Place hinge ⑤ at the panel A and F as shown. Then tighten the hinge ⑤ with 2 screws ② and 2 screws ⑧.

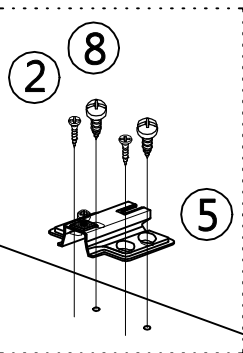

Pre - Assembly

Insert the PVC dowels ④ to panel B, C, D and E's non-thru holes as shown, using hammer to tap them in.

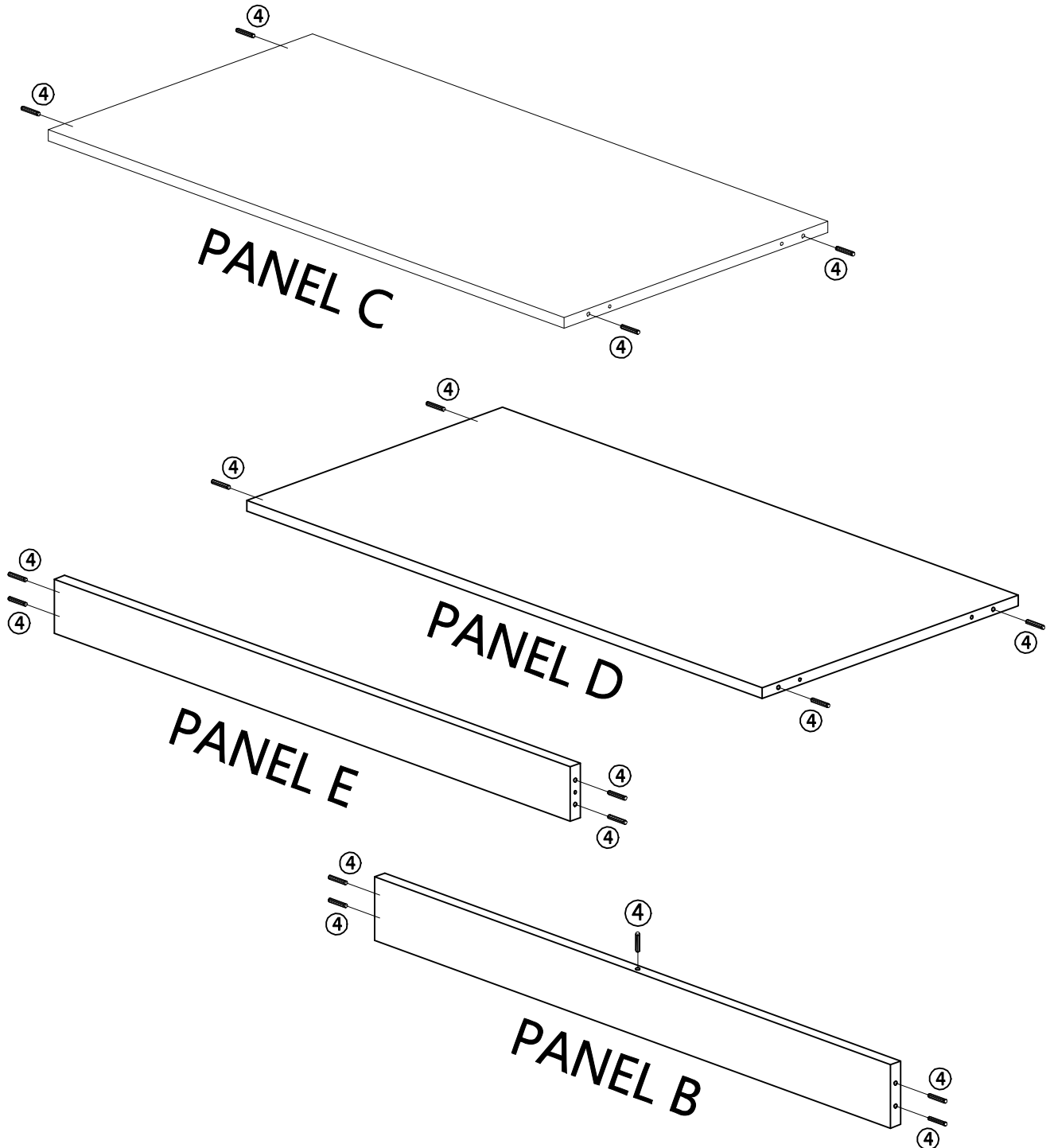

Door Panel Assembly Instruction Step 1

* Insert 6 Hinges ⑤ into door panel J and K's non-thru hole as shown, then tighten screws ② through hinges ⑤'s thru hole.

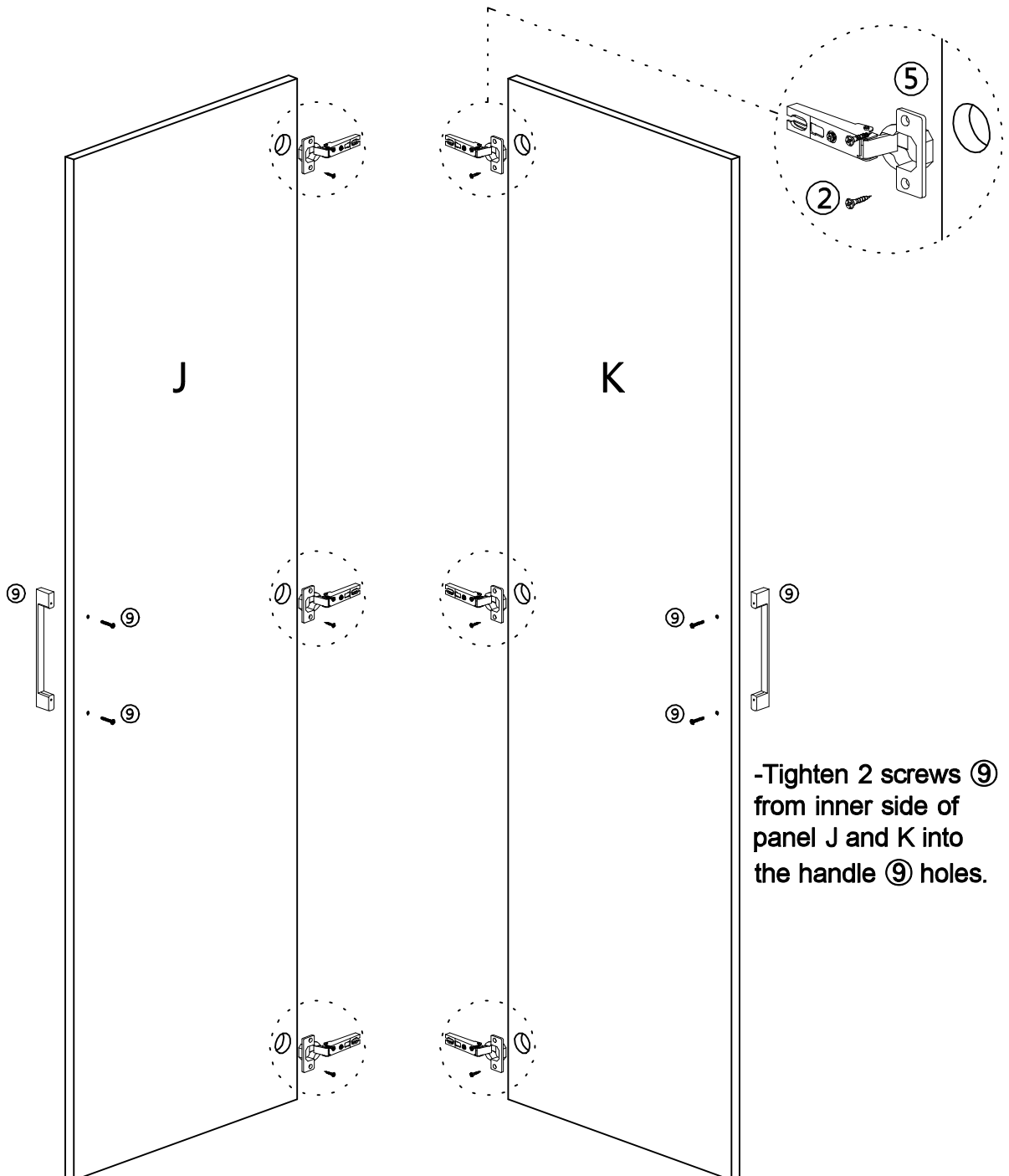

-Tighten 2 screws ⑨ from inner side of panel J and K into the handle ⑨ holes.

Assembly Instruction Step 1

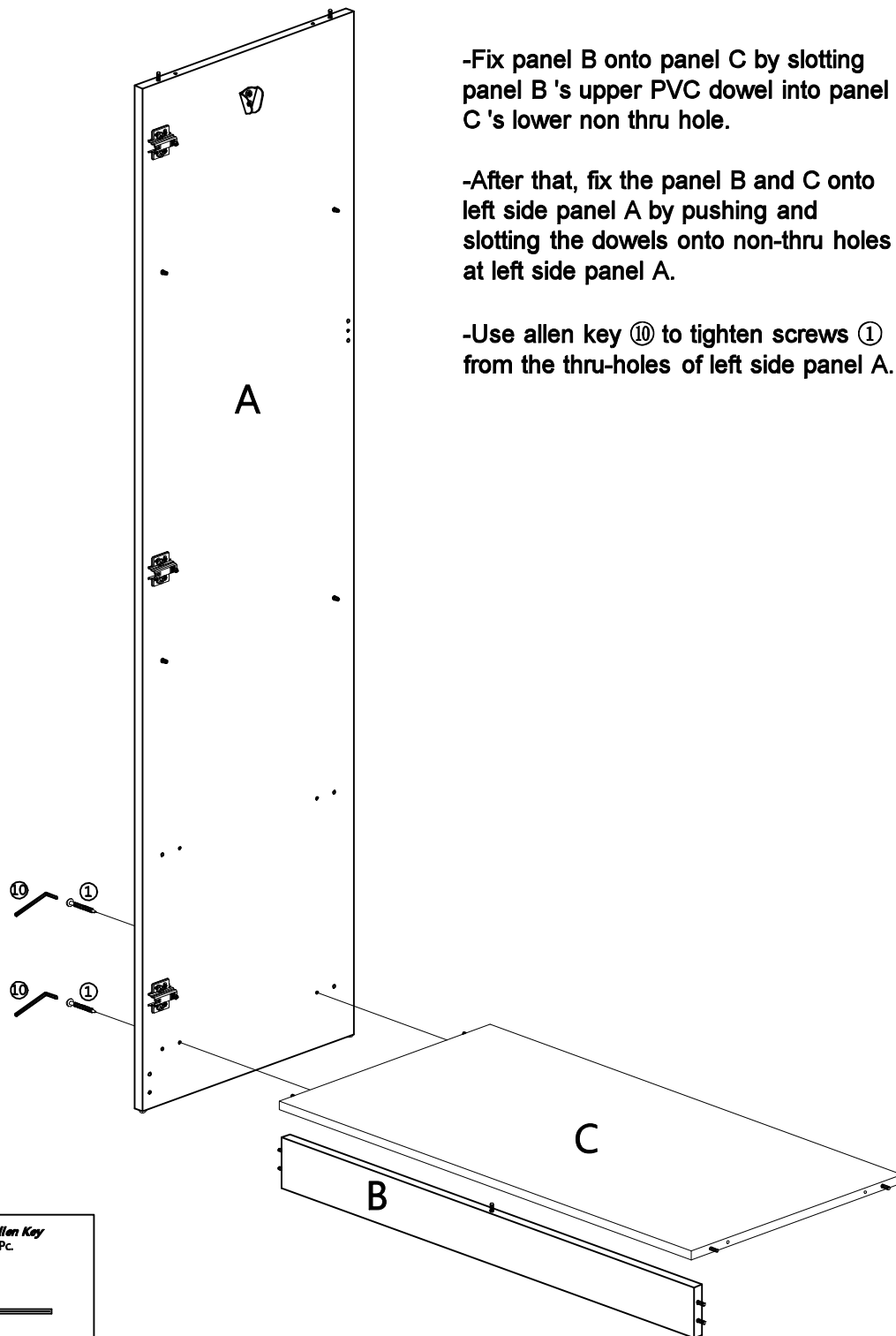

-Fix panel B onto panel C by slotting panel B's upper PVC dowel into panel C's lower non thru hole.

-After that, fix the panel B and C onto left side panel A by pushing and slotting the dowels onto non-thru holes at left side panel A.

-Use allen key ⑩ to tighten screws ① from the thru-holes of left side panel A.

① Screw
M 6 x 40mm
2 Pcs.

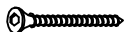

⑩ Allen Key
1 Pc.



Assembly Instruction Step 2

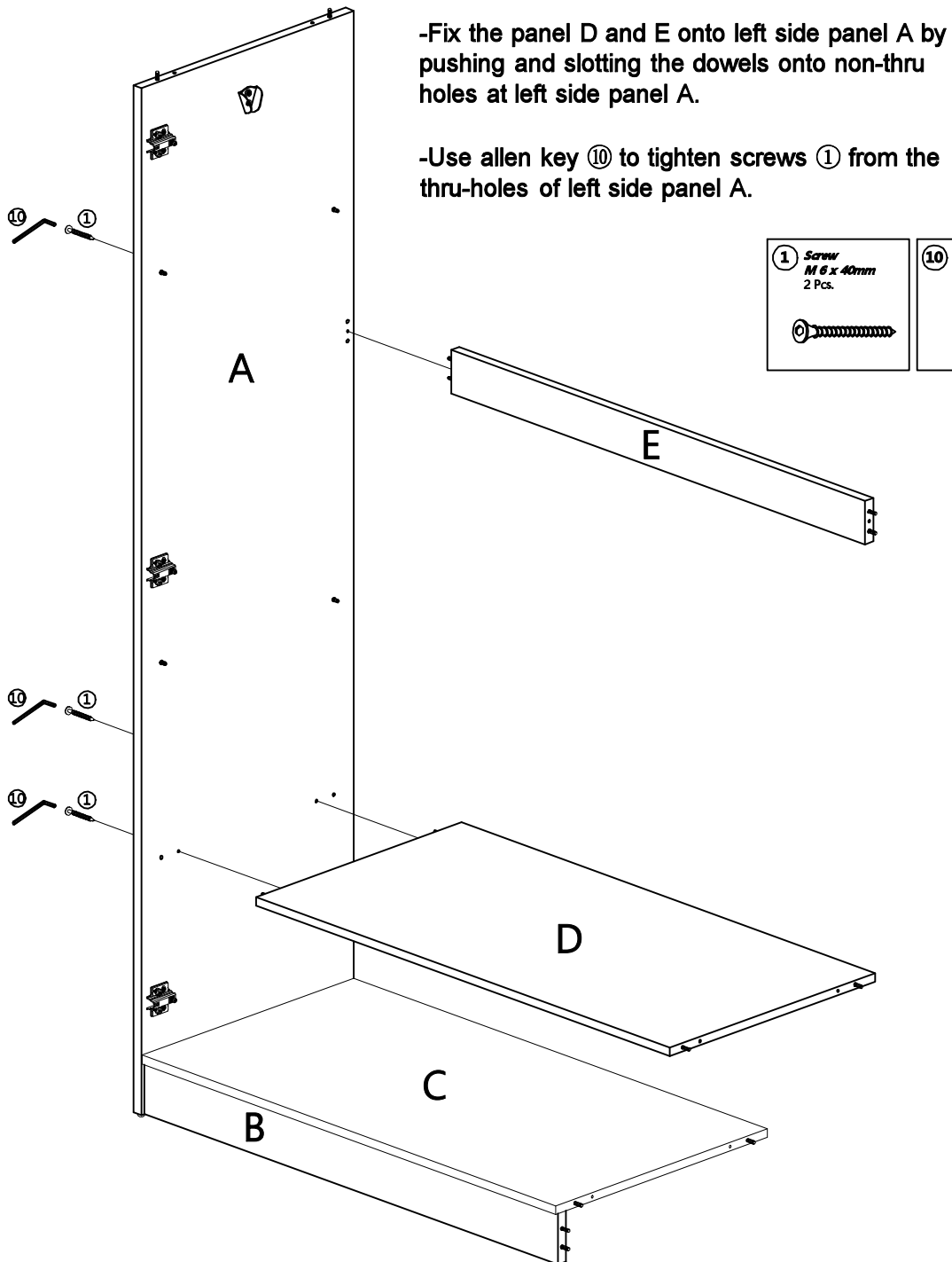

CAUTIONS : When Push / Slot the PVC Dowels to non-thru holes, don't push to hard. Otherwise, the side panels (A & F) may be damaged.

Assembly Instruction Step 3

-Fix the right side panel F onto panel B, C, D and E by pushing right side panel F leftward and slotting the dowels onto non-thru holes at right side panel F.

-Use allen key ⑩ to tighten screws ① from the thru-holes of right side panel F.

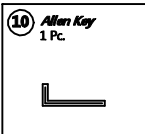
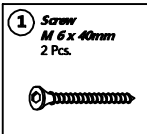
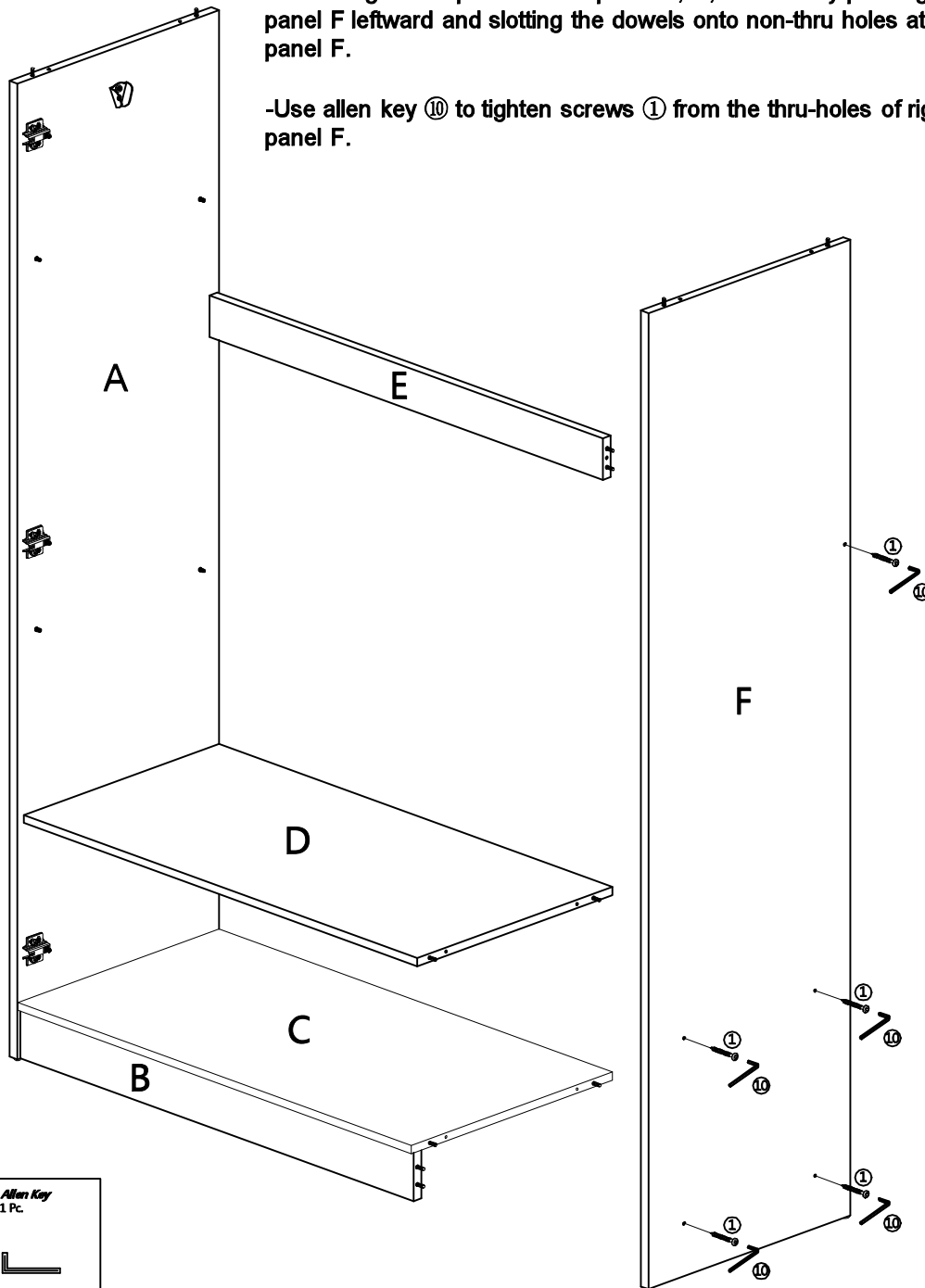

CAUTIONS : When Push / Slot the PVC Dowels to non-thru holes, don't push to hard. Otherwise, the side panels (A & F) may be damaged.

Assembly Instruction Step 4

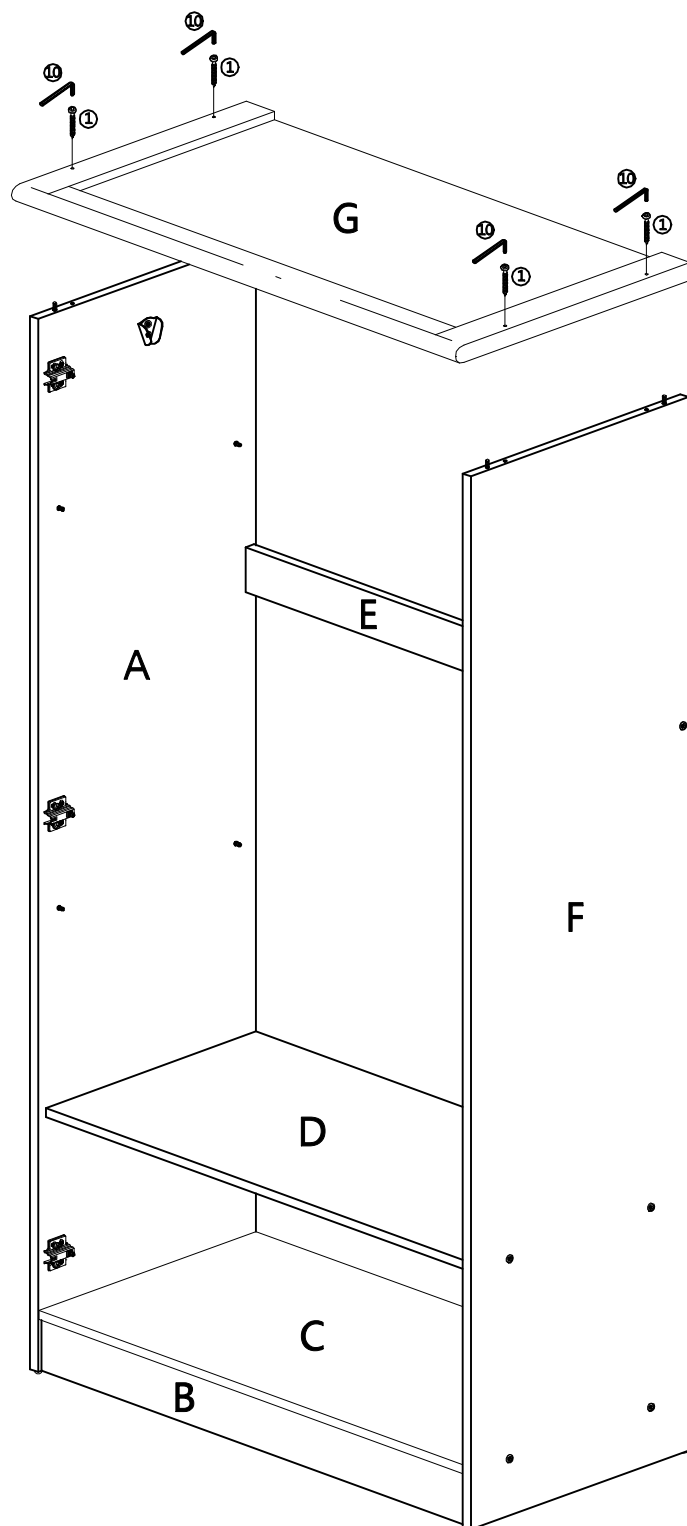

-Place and fix panel G onto panel A and F and align properly by pushing and slotting the 4 (down) dowel onto the non thru holes at top edge of panel A and F. At the same time, slotting panel A and F's top dowel onto panel G's bottom thru hole, pushing and light tapping of panel G downward to have panel G, panel A, panel F fix tightly.

-Use allen key ⑩ to tighten screws ① from the thru-holes of panel G.

Assembly Instruction Step 5

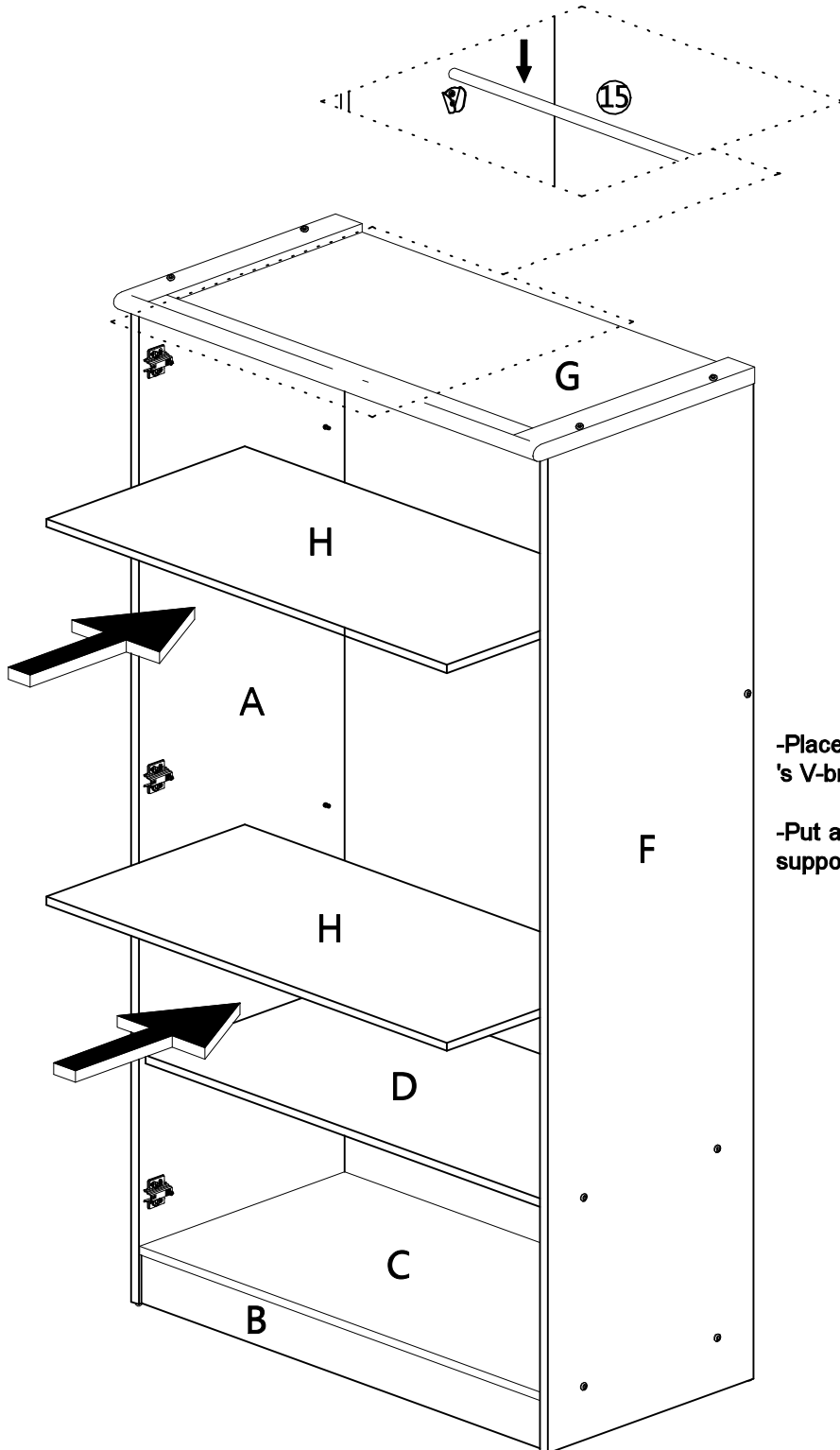

-Place iron tube onto both panel A and F's V-bracket.

-Put adjusting panels H onto shelf supports as shown.

Assembly Instruction Step 6

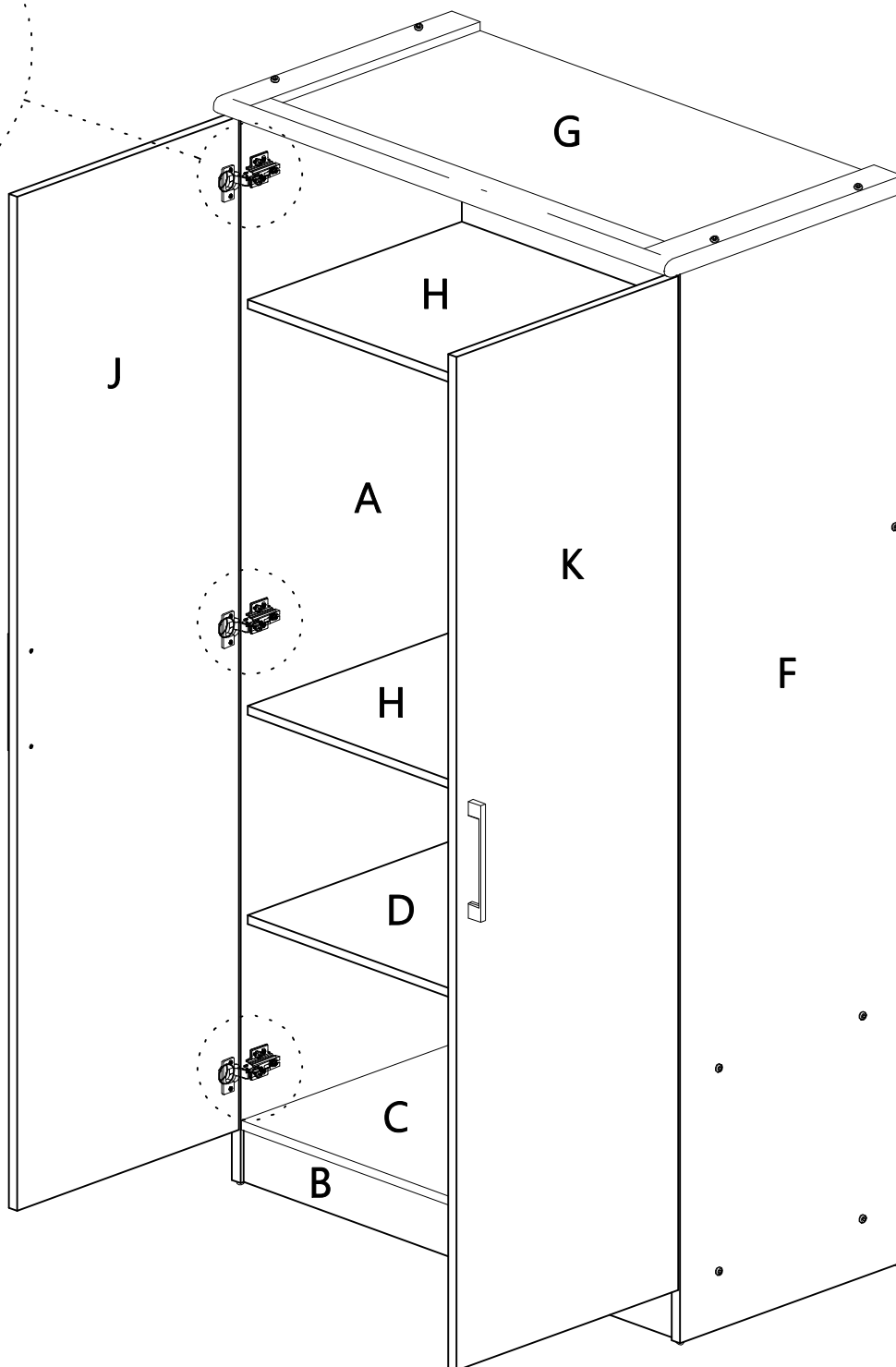
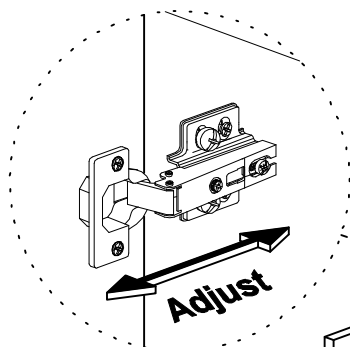

Join the panel J and K's hinges with panel A and F's hinges as shown.

You can align the door panel J and K by tightening and loosening the screws as shown.

Assembly Instruction Step 7

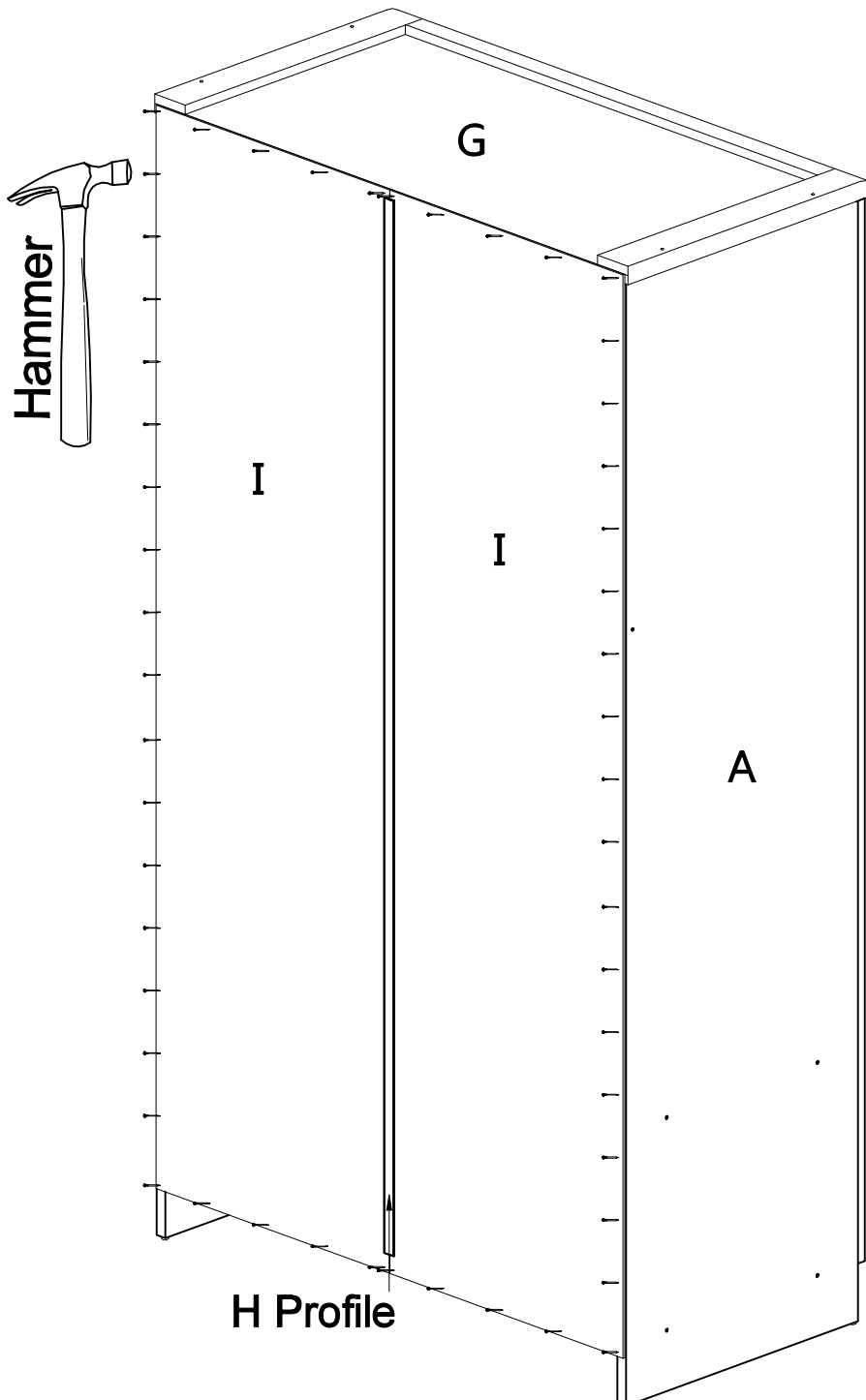

Place 2 back Panels I onto the back of the main unit, and join the 2 panel I together with H-profile by slotting one side each of panel I into the track of H-profile. Then align them properly for nailing.

Then use hammer to nail the nails one by one and at center of 4 side edges. Gap between 2 nails is about 100mm for all.

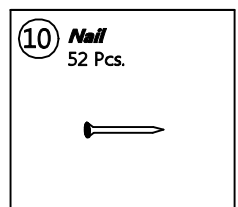

Assembly Instruction Step 8

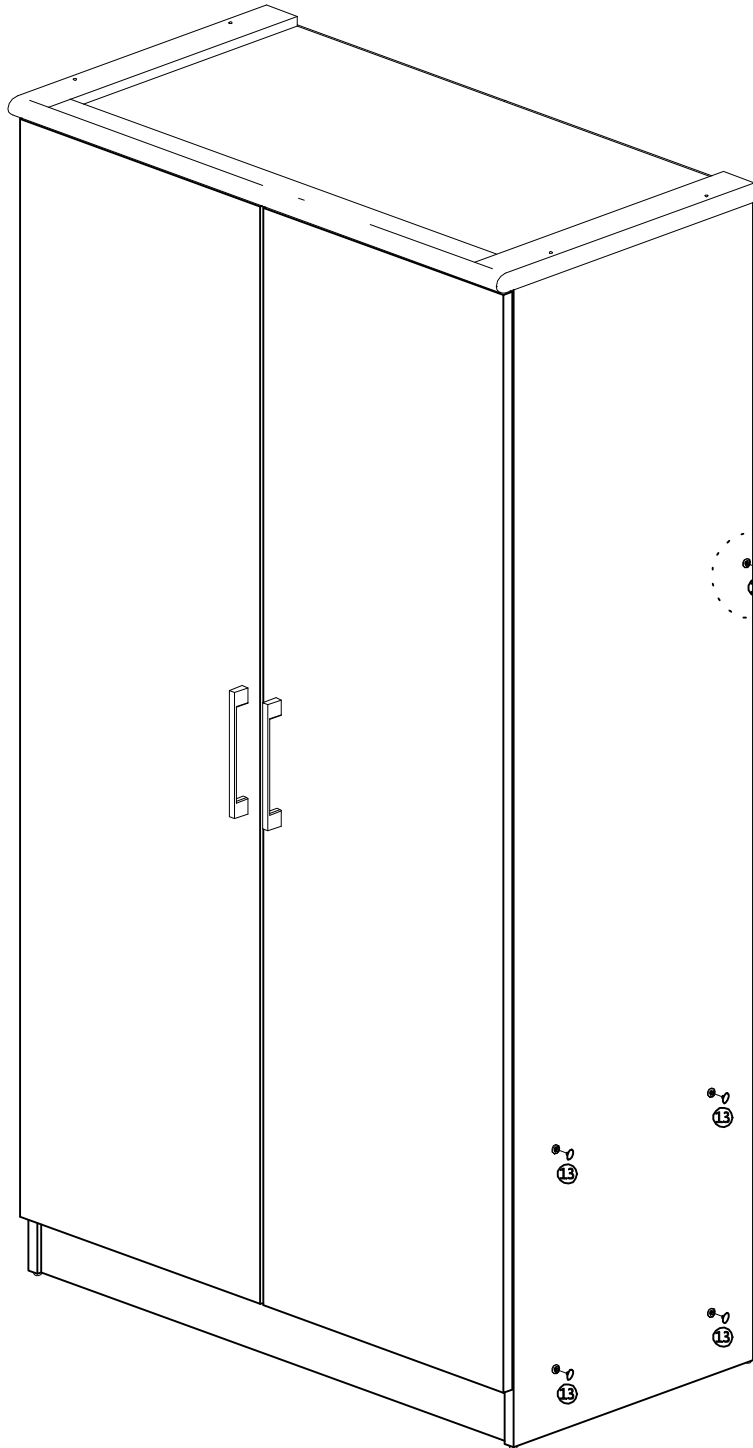

Cover all the screws ① and screws ⑫ ' head with PVC cap ⑬ provided by pushing cover's stem onto the hole of screw heads one by one for all screws.

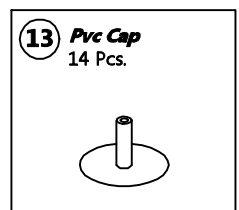

Assembly Instruction Step 9

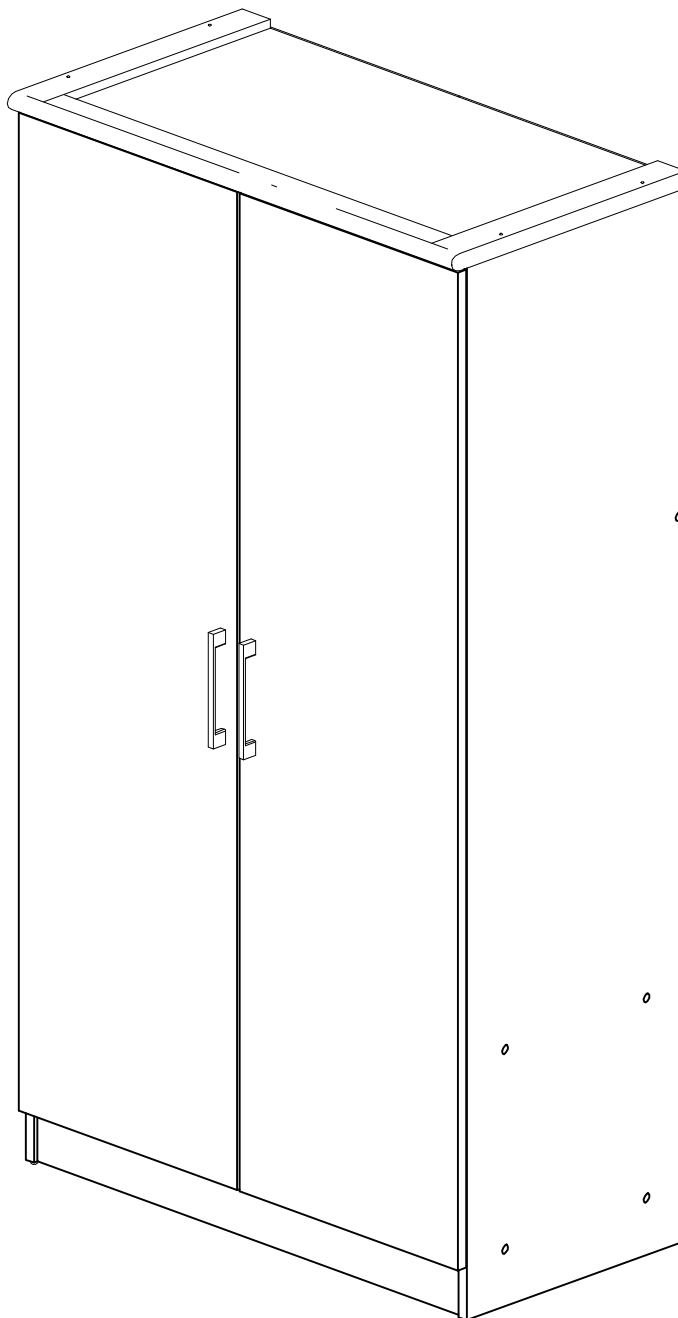

Completion

In the interest of our environment please dispose of all packaging thoughtfully.