

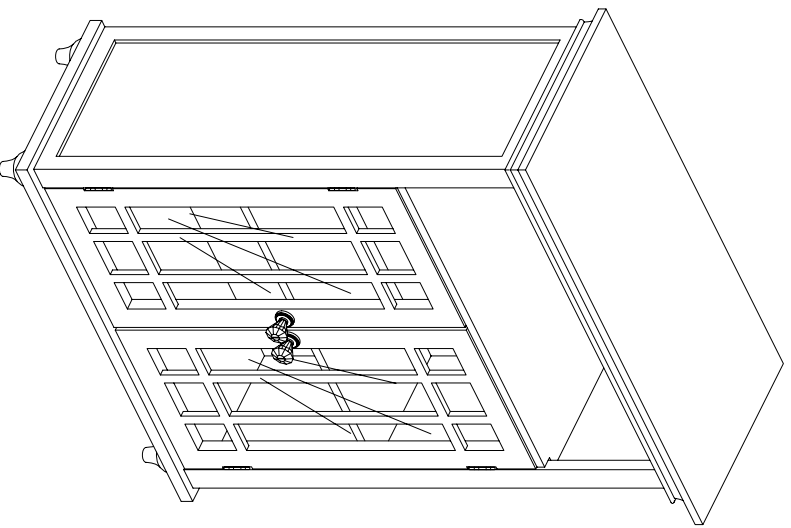

# Assembly Instructions - Floor Cabinet with 2 Doors







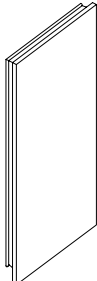
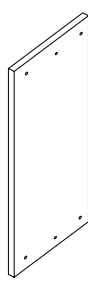
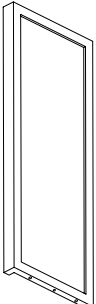
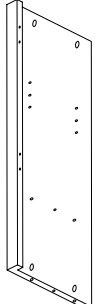
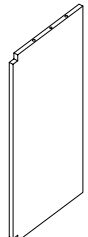
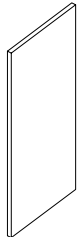
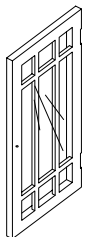
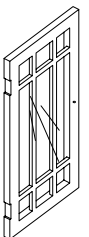
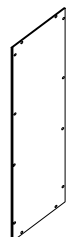
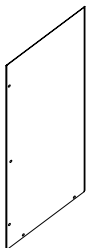
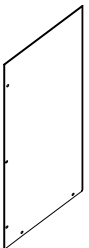



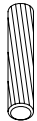

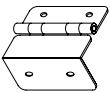

**ASSEMBLY INSTRUCTIONS - IMPORTANT**  
Carefully unpack & identify each component before attempting to assemble. Refer to parts list. Please take care when assembling the unit and always set the parts on a clean, soft surface. If you require any assistance with assembly, parts, please call 866-931-4207.

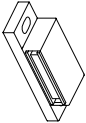
**INSTRUCCIONES PARA ARMAR - IMPORTANTE :**  
Desempaque cuidadosamente e identifique cada componente antes de tratar de empezar su ensambladura. Verifique la lista de partes. Por favor tenga cuidado cuando arme la unidad y siempre coloque las piezas sobre una superficie plana, suave y limpia. Si necesita ayuda con el armado, por favor llamada 866-931-4207.

**DIRECTIVES DE MONTAGE-IMPORTANT :**  
Avant de commencer l'assemblage, déballez délicatement toutes les pièces et repérez-les sur la liste des pièces. Procédez avec soins durant l'assemblage et posez toujours les pièces sur une surface propre, douce et lisse. Si vous avez besoin d'aide contactez l'assemblage Svp appel 866-931-4207.

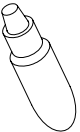
|           |  |       |   |
|-----------|--|-------|---|
| <b>A.</b> | Top Shelf<br>Estante Superior<br>Étagère Supérieure  | 1 PC  |  |
| <b>B.</b> | Bottom Shelf<br>Estante Inferior<br>Étagère Inférieure   | 1 PC  |  |
| <b>C.</b> | Side Panel - Left<br>Panel Lateral - Izquierdo<br>Panneau Lateral - Gauche                             | 1 PC  |  |
| <b>D.</b> | Side Panel - Right<br>Panel Lateral - Derecho<br>Panneau Lateral - Droite                              | 1 PC  |  |
| <b>E.</b> | Fixed Level Shelf<br>Estante De Nivel Fijo<br>Étagère Fixée  | 1 PC  |   |
| <b>F.</b> | Adjustable Shelf<br>Estante Ajustable<br>Étagère Réglable  | 1 PC  |    |
| <b>G.</b> | Left Door<br>Puerta Izquierda<br>Porte Gauche  | 1 PC  |    |
| <b>H.</b> | Right Door<br>Puerta A La Derecha<br>Porte Droite  | 1 PC  |    |
| <b>I.</b> | Upper Backboard<br>Tablero Trasero Superior<br>Panneau En Arrière Supérieur                            | 1 PC  |    |
| <b>J.</b> | Lower Left Backboard<br>Un Tablero Trasero Izquierdo Más Bajo<br>Panneau Arrière Gauche De Ci-Dessous  | 1 PC  |    |
| <b>K.</b> | Lower Right Backboard<br>Un Tablero Trasero La Derecha Más Bajo<br>Panneau Arrière Droit De Ci-Dessous | 1 PC  |    |
| <b>L.</b> | Legs<br>Piernas<br>Jambes  | 4 PCS |    |

|       |   |        |  |
|-------|---|--------|--|
| (1).  | Wooden Dowel<br>Clavija De Madera<br>Goujon En Bois                 | 6 PCS  |   |
| (2).  | Cam Bolt<br>Perno De Leva<br>Boulon De Came                         | 8 PCS  |  |
| (3).  | Cam Lock<br>Cerradura De Leva<br>Serrure De Came                    | 8 PCS  |   |
| (4).  | Cam Lock Cover<br>Tapa Para Cerradura<br>Couverture Pour Serrure    | 8 PCS  |   |
| (5).  | Phillips Screw (ø 3*12 mm)<br>Tornillo De Cruz<br>Vis Cruciforme    | 24 PCS |   |
| (6).  | Hinge<br>Bisagra<br>Charnière                                       | 4 PCS  |     |
| (7).  | Phillips Screw (ø 3*12 mm)<br>Tornillo De Cruz<br>Vis Cruciforme    | 16 PCS |     |
| (8).  | Magnet<br>Imán<br>Aimant  | 1 PC   |    |
| (9).  | Shelf Pin<br>Perno De Estante<br>Agrafe D' étagère                  | 4 PCS  |     |
| (10). | Knob<br>Perilla<br>Bouton   | 2 PCS  |     |
| (11). | Phillips Bolt (ø 5/32*3/4")<br>Perno De Cruz<br>Boulon Cruciforme   | 2 PCS  |     |
| (12). | Glue<br>Pegamento<br>Colle  | 1 PC   |    |
| (13). | Phillips Screw (ø 4mm*1 1/2")<br>Tornillo De Cruz<br>Vis Cruciforme | 4 PCS  |     |

## STEP 1 ÉTAPE 1 PASO 1

( Fill dowel hole half way with glue. Dowel may push out excess glue-wipe off excess glue )  
( Llene mitad del agujero de clavija con pegamento. Clavija eliminará el exceso-limpe exceso )  
( Remplissez demi de trou de goujon avec colle. Goujon éliminera la colle excessive-nettoyez l'excèsif )

Note: Do not over drill. Power tools  
Not recommended.

Nota: Demasiado. No se recomienda  
el herramientas eléctricas.

Note: Ne percez pas trop. Outils  
électriques non recommandé.

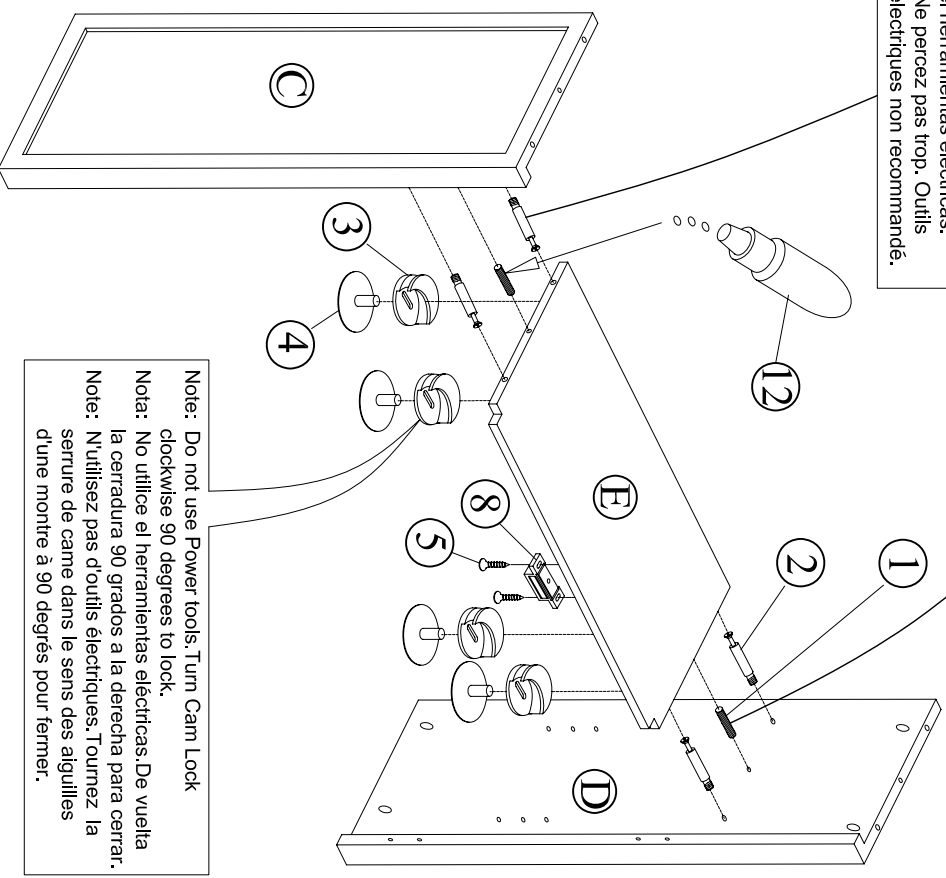

Note: Do not use Power tools. Turn Cam Lock  
clockwise 90 degrees to lock.

Nota: No utilice el herramientas eléctricas. De vuelta  
la cerradura 90 grados a la derecha para cerrar.

Note: N'utilisez pas d'outils électriques. Tournez la  
serrure de came dans le sens des aiguilles  
d'une montre à 90 degrés pour fermer.

STEP 2  
ÉTAPE 2  
PASO 2

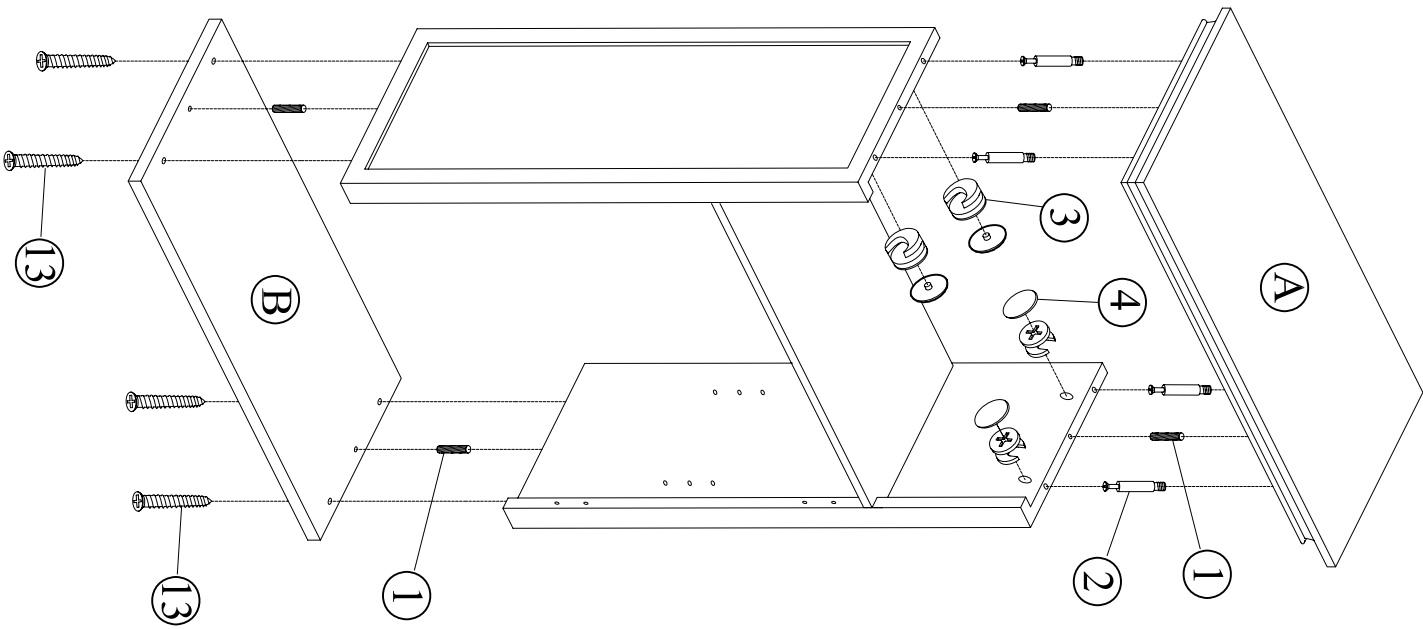

STEP 3  
ÉTAPE 3  
PASO 3

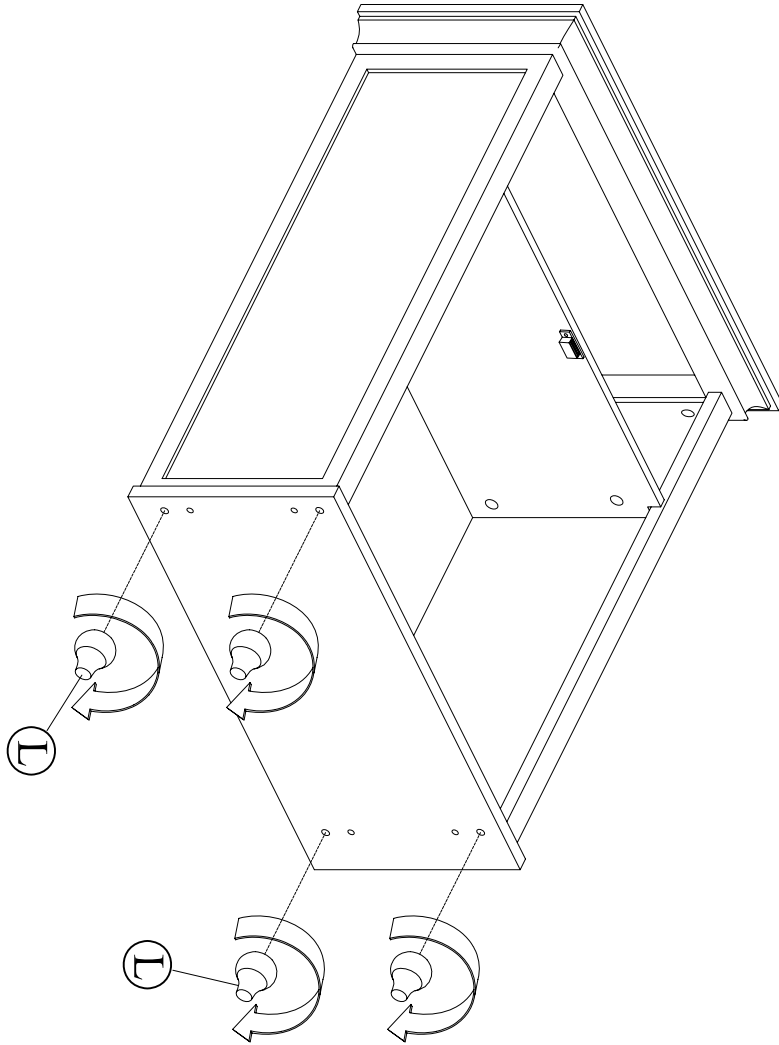

STEP 4  
ÉTAPE 4  
PASO 4

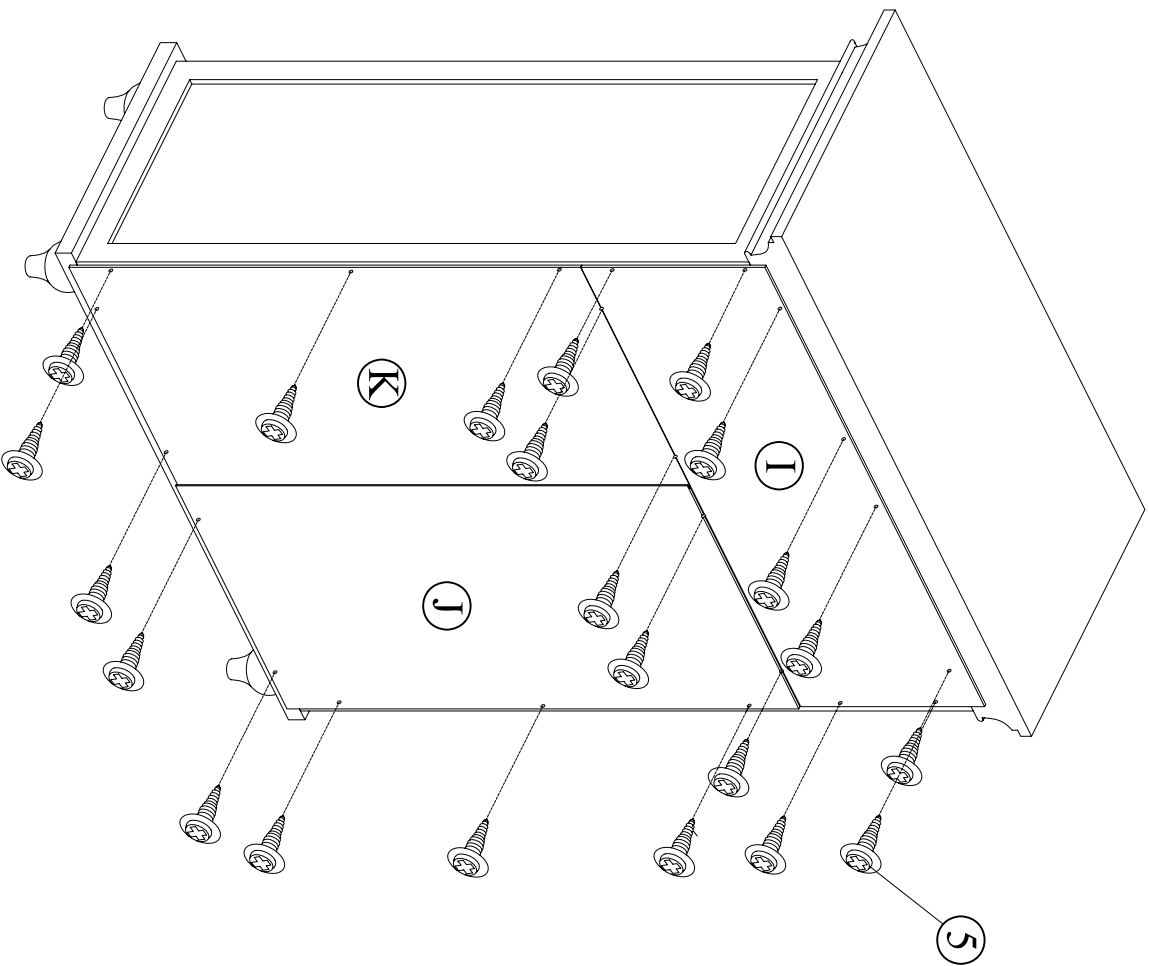

STEP 5  
ÉTAPE 5  
PASO 5

