

# INSTALLATION AND CARE GUIDE

## WOODBIDGE<sup>®</sup>

### AIR AND WHIRLPOOL HEATED BATHTUB

**BJ100 BJ400 BJ500 BJ600 BJ700**

**Certified to the following Codes & Standard:**

- UL 1795 Safety Standard for Hydromassage Bathtubs (UL1795)
- ASME A112.19.7 / CSA B45.10) – Hydromassage Bathtub Systems
- CSA B45.5/IAPMO Z124 – Plastic Plumbing Fixtures
- International Plumbing Code<sup>®</sup> (IPC)
- International Residential Code<sup>®</sup> (IRC)
- Uniform Plumbing Code<sup>®</sup> (UPC)
- National Plumbing Code of Canada<sup>®</sup> (NPC)



**READ ALL INSTRUCTIONS BEFORE UNPACKING THE PRODUCT**



Must hire a licensed electrician to install a dedicated 120V, 30 Amp circuit breaker for the BJ-series-hardwired 3-in-1 whirlpool tubs. The electrician also needs to verify the connected electrical wiring can handle a 30 Amp current.

WOODBIDGE is not responsible for product damage/malfunction caused by incorrect electrical installation. WOODBRIDGE is also not responsible for property damage caused by incorrect electrical installation.

INSTRUCTIONS THAT, IF IGNORED COULD RESULT IN DEATH OR SERIOUS INJURY CAUSED BY INCORRECT HANDLING OR INSTALLATION OF THE PRODUCT. THESE INSTRUCTIONS MUST BE OBSERVED FOR SAFE INSTALLATION.

**CAUTION!**



**TWO PEOPLE  
LIFT REQUIRED**

**2 PEOPLE ARE REQUIRED TO LIFT AND DURING  
ENTIRE INSTALLATION OF THIS PRODUCT**

This products must be installed by a fully insured and licensed plumber only. Installation of any our product by anyone other than fully insured and licensed plumber shall void limited warranty. We recommen that such licensed plumber has experience in the installation of products.

We are not responsible for local code compliance for this product. Building and plumbing codes may vary from state-to-state in accordance to your location. We are not responsible for providing any compliance certifications.

Under no circumstances we shall not be liable for any incidental damages sustained in connection with this product

Neither manufacture, nor distributor, nor retailer is responsible for water damage or flood caused due to use of this product.

Under no circumstances we shall not be liable for any and all fees, cost of installation/reinstallation/removal, subsequent damage or transportation in case of the product defect

Customer Service Phone: 562-229-0088. (Monday - Friday 9 AM - 5 PM Pacific Time)

Or Email: [help@woodbridgebath.com](mailto:help@woodbridgebath.com)

20231010 REV. 2

## BEFORE YOU BEGIN

- Please read these instructions carefully to familiarize yourself with the required tools, materials, and installation sequences. Follow the sections that pertain to your particular installation. This will help you avoid costly mistakes. In addition to proper installation, read all operating and safety instructions.
- All information is based on the latest product information available at the time of publication. WOODBRIDGE® reserves the right to make changes in product characteristics, packaging, or availability at any time without notice.

## PRODUCT REQUIREMENTS

### A. Summary Of Key Requirements

Observe all local plumbing codes, Install the unit to a level subfloor, Provide properly -dimensioned framing.

### B. Product Inspection

Uncrate and inspect bathtub for damages. Leave all materials in the crate during construction to prevent damage.

## ROUGHING-IN

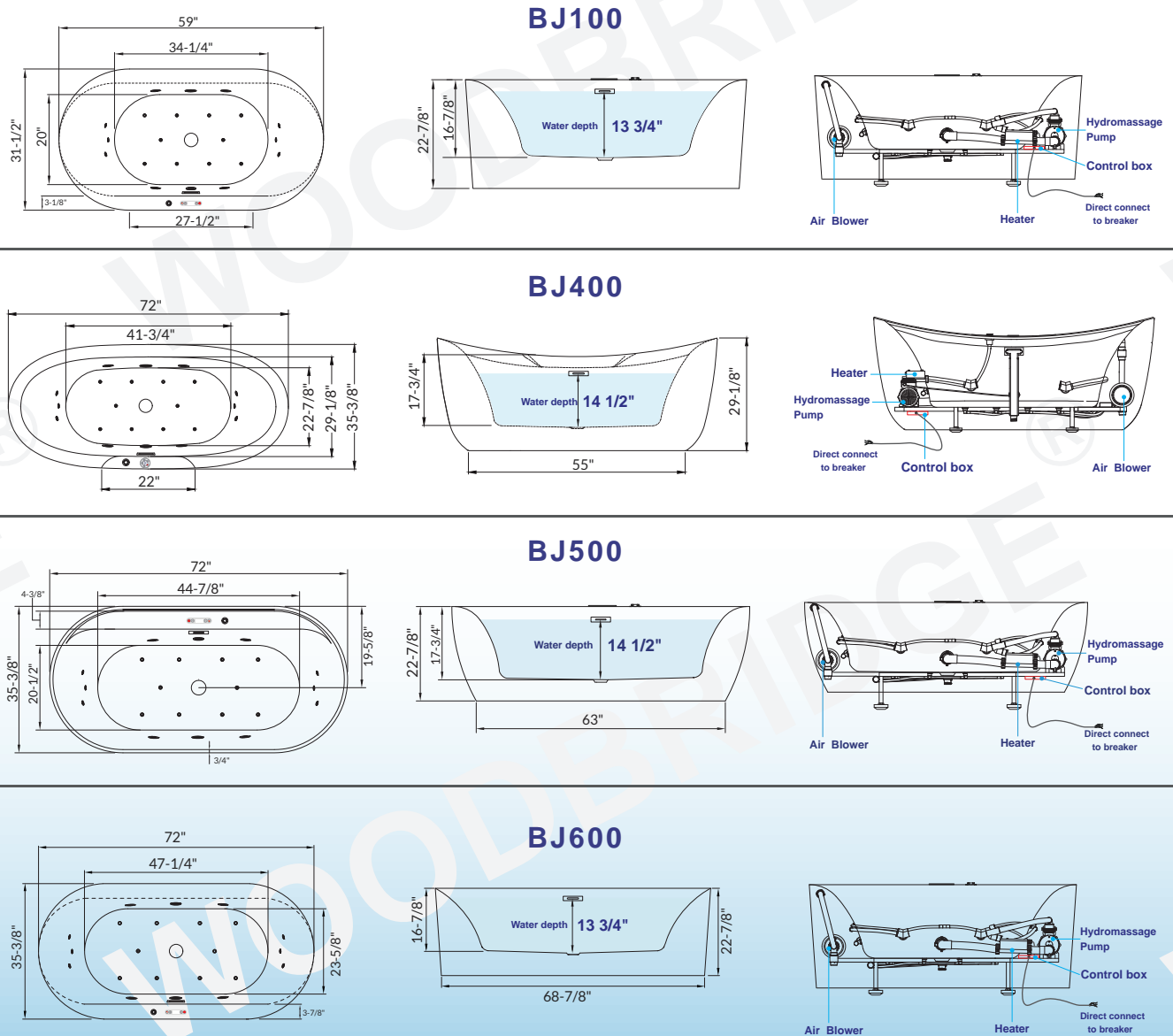

## BJ700

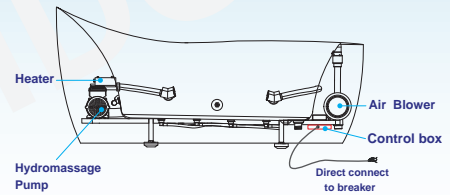
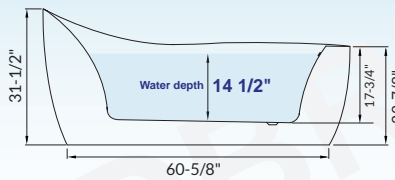
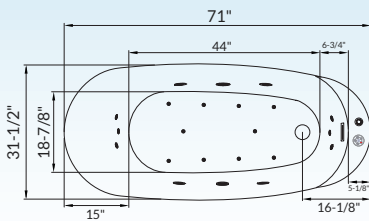

Tub Inline Heater to Maintain Water Temperature\*

### IMPORTANT INFORMATION

- Measurements are  $\pm 1/2$ " and subject to change without notice
- Specifications & Configurations are subject to change without notice
- Please measure tub on-site before installation
- Please note that installer(s) must be certified or warranty will be voided.
- Measurements herein supersede all others published prior to publication date shown below
- Before ordering or installing, please consider future access to equipment

## INSTALLATION REQUIREMENTS

### A. Tools Required

- Adjustable pipe
- wrench
- Ruler
- Level
- Safety shoes
- Safety glasses
- Square
- Screwdriver
- Pliers
- Utility knife

### B. Materials Required:

- Plumbers putty
- Wall coverings, as necessary
- Silicone sealant
- Gypsum cement (optional)
- Construction adhesive
- (optional)
- Protective covering for
- bathtub
- Nails

### C. Clearance Requirements:

Check the rough-in and room dimensions to provide adequate space for the bath unit.

## SITE REQUIREMENTS

### A. Plumbing Preparation

Position the plumbing according to rough-in dimensions.  
Cap the supplies and check for leaks.

**CAUTION:** Ensure a watertight seal on the bath drain connections.

- Install the faucet valving and shower head tee. When drilling bathtub for faucet, ensure sufficient clearance. Open the hot and cold water valves and check the supply connections for leaks.
- Run water into the bath and check the drain connections for leaks.
- Fill the bathtub up to the overflow level and check overflow unit for leaks.

## INSTALL BATHTUB

**This products must be installed by a fully insured and licensed plumber only.**

- 1) Your new bathtub has been manufactured to the highest possible standards, it has been tested and approved by factory
- 2) When removing bathtub from protective carton. **DO NOT LIFT BATHTUB BY PIPE WORK.** Inspect for any possible damage that may have occurred in transit.  
**IMPORTANT:** Bathtub must be installed level on all top edges.

- 3) Set the bathtub on two 4x4 pieces of lumber .so you can access from the bottom of the bathtub.
- 4) Connect Power Supply:  
Connect power supply to control unit. The electrical connections must comply with local authority regulations and must be done by an authorized electrician.
- 5) Fill bathtub with water to approximately 40 mm(1.6") above the jets and trial run pump for 10-15 minutes. Check all the fittings for leaks and test the control functions. Switch off the spa pump and leave the unit filled with water (pump is not running) for at least another two minutes. Check the pump and pipes union connections for leaks. Hand tighten union connections if required.

**IMPORTANT:** Your bathtub has been factory tested and approved. It is the responsibility of the installer to test run the bathtub, check all the fittings for leaks and test the control functions. **NON OBSERVANCE WILL INVALIDATE FACTORY WARRANTY.**

- 6) The unit must be connected only to a supply circuit that is protected by a Ground-Fault Circuit Interrupter (GFCI). Such a GFCI should be provided by the installer and should be tested on a routine basis.

## WOODBIDGE<sup>®</sup> WHIRLPOOL & AIR BATHTUB



**HEATED AIR MASSAGE TUB, HEATED WHIRLPOOL TUB**

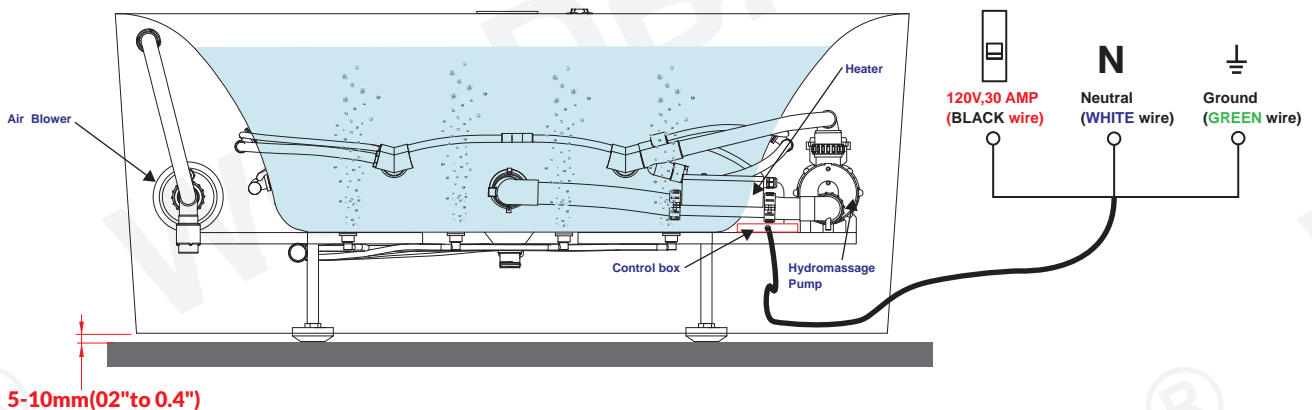

**!** Must hire a licensed electrician to install a dedicated 120V, 30 Amp circuit breaker for the BJ-series-hardwired 3-in-1 whirlpool tubs. The electrician also needs to verify the connected electrical wiring can handle a 30 Amp current.

WOODBIDGE is not responsible for product damage/malfunction caused by incorrect electrical installation. WOODBRIDGE is also not responsible for property damage caused by incorrect electrical installation.

**!** For Air Bath and Whirlpool Tub installation, Do not apply any silicone sealant after installation, leave a 5-10mm(0.2" to 0.4") gap for motor/pump ventilation purpose.

The tub inline heater is not designed to be a water heater. It is intended to maintain the warmth of the water.

# WOODBIDGE® WHIRLPOOL & AIR & HEATER



## 3-in-1 JETTED TUB (for single Hardwired model only)

**⚠ CLARIFICATION:** WOODBRIDGE has two types of jetted tubs. This diagram is for the model with **all functions combined into one single wire that needs to be hardwired**. This unit does **NOT** come with a power plug.

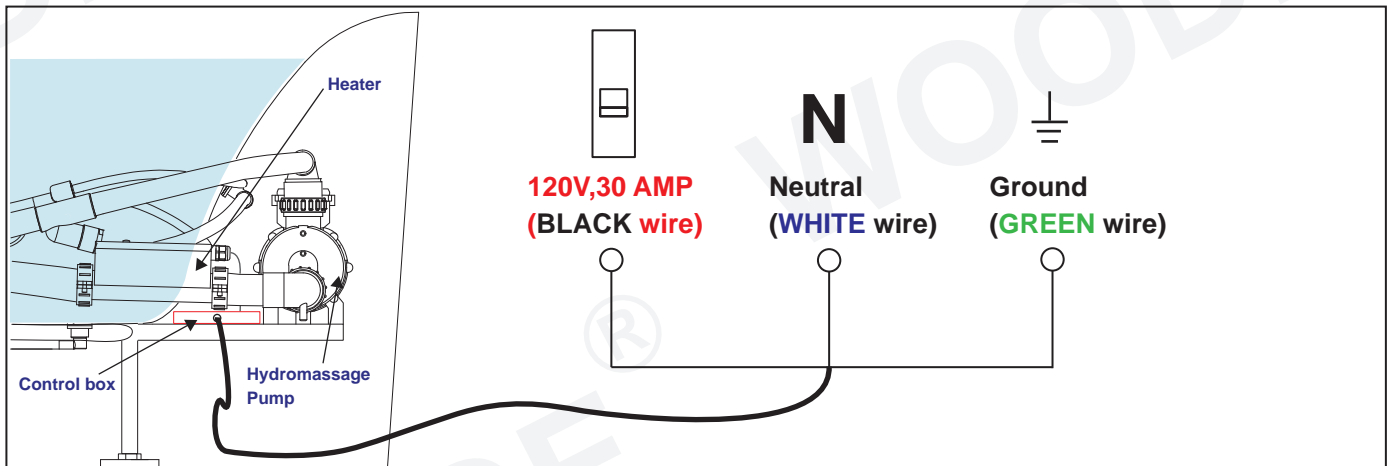
	<p><b>MUST</b> connect to <b>ONE</b> dedicated <b>120V, 30A</b> circuit breaker</p>	<p><b>IMPORTANT:</b> Must use a certified electrician to verify and to install your electrical system, including the breaker, wiring, outlets, switches, etc. Incorrect electrical installation will damage the tub and void the warranty.</p>
---	---	--



	<p>Tub inline heater is designed to <b>MAINTAIN</b> the water temperature. It does <b>NOT</b> rapidly heat up the water.</p>	<p>The best way to use the tub inline heater: <b>First</b>, use a faucet (not included) to fill up the tub with water at a desirable temperature, such as at 100 °F (38 °C). <b>Second</b>, set the heater to 100 °F (38 °C). The heater will be activated when the water temperature drops. If you fill up the tub with room temperature water, such as at 65 °F (18°C), it may take 2-3 hours for the water to reach 100 °F (38 °C), if ever. (* Actual heating speed will vary based on environmental factors.)</p>
---	--	--

	<p><b>!! Do NOT</b> connect the <b>WHITE</b> wire to another <b>"HOT"</b> wire</p>	<p><b>WARNING:</b> Do <b>NOT</b> connect the <b>WHITE</b> wire on the tub to another "HOT" wire. The <b>WHITE</b> wire on the tub is the <b>Neutral</b> wire. <b>Only</b> connect the <b>BLACK</b> wire on the tub to 110V "HOT" wire. Incorrect wiring will damage the tub and void the warranty. (You may need to purchase a replacement control box or transformer to fix this mistake.)</p>
	<p><b>!! Do NOT</b> connect to a <b>240V</b> power</p>	<p>You will overload and damage the electrical components instantly. This will void the warranty. (You may need to purchase a replacement control box or transformer to fix this mistake.)</p>
	<p><b>!! Do NOT</b> connect to insufficient <b>5A / 10A / 15A / 20A / 25A</b> Power</p>	<p>Insufficient power will trigger your circuit breaker to stop the power supply. The tub will stop working. You may also damage the electrical components. This voids the warranty.</p>

### **⚠ IMPORTANT ELECTRICAL TESTING PROCEDURE:**

When testing the electrical components and the wiring, please **1.** fill up the tub first. (The whirlpool jet cannot to be turned on unless the tub is filled up.) **2.** please turn on the whirlpool jet, air bubble blower, and set the heater to 40°C **AT THE SAME TIME**. **3.** Please let it run for 15 minutes. (\* If the water is already hotter than 40°C, you will need to set the inline heater at a higher temperature.)

If your breaker is tripped and the power is stopped, that means your circuit breaker may **NOT** be powerful enough (less than 30 Amp). Please have an electrician to check/upgrade your electrical system.

# 1. Schematic diagram for main control box

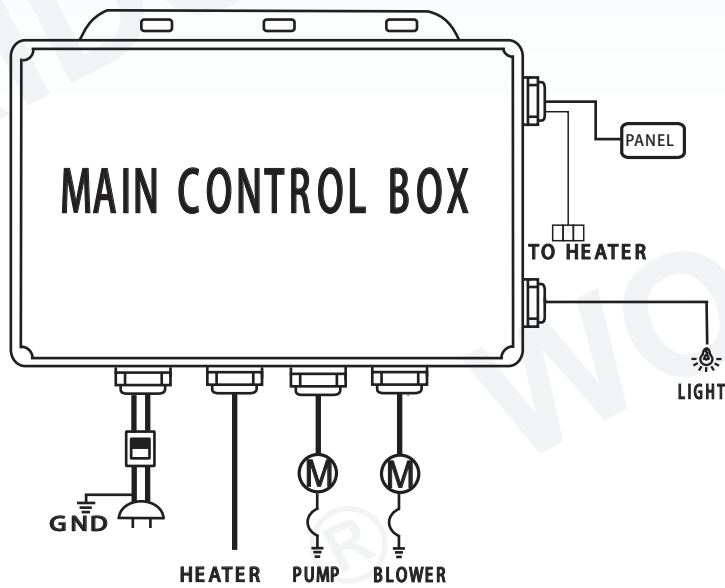

# 2. Control Panel Icons

**BJ100**

**BJ500**

**BJ600**

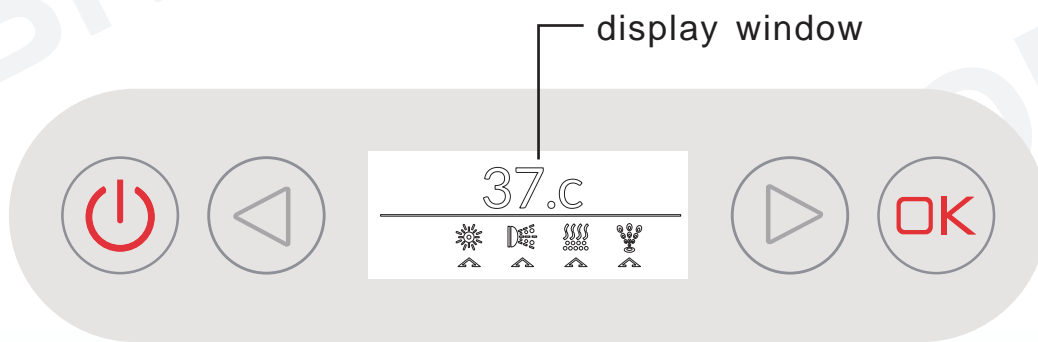

Power/Function



Right/Up



Left/Down



OK button



Chromo Therapy light



Wave Massage























Thermostate



Air Bubble



### 3. Operating Instruction on Control Panel

- (1) **POWER ON/OFF:** Press and hold the power button  for 2 seconds to turn it on. Repeat the same operation to turn off the power.
- (2) **CHROMO THERAPY LIGHT ON/OFF:** When power is on keep touching the Left and Right   buttons until the cursor on the LCD is on the Chromo Therapy light position , press the OK  button and the light will work; repeat the same operation to turn off the light.
- (3) **AIR BUBBLE ON/OFF:** When power is on, keep touching the Left and Right   buttons until the cursor on the LCD is on the Air Bubble position , press the OK  button and the air bubble blower will start to function; repeat the same operation to turn off the Air bubble blower
- (4) **WAVE MASSAGE ON/OFF:** When power is on, keep touching the Left and Right   buttons until the cursor on the LCD is on the Wave Massage  position, then press OK  button, the Wave massage will start to function and repeat the same operation to turn off the wave massage. (Make sure there is enough water inside the tub)
- (5) **HEATER ON/OFF:** ONLY FUNCTION when wave massage is running. When power is on keep touching the Left and Right   buttons until the cursor on the LCD is on the Thermostat  position and press the OK  button to turn on, repeat the same operation to turn it off.
- (6) **TEMPERATURE SETTING:** When heater is running, press the function  button until the digital twinkle on display temperature on LCD display. Press the Left/Down  button to decrease the temperature by 1°C, press the Right/Up  button to increase the temperature by 1°C





**\*\* DO NOT Power on the water pup if there is no enough water inside the tub.**

**\*\* The setting temperature range is between 86°F to 122°F (30°C - 50°C)**

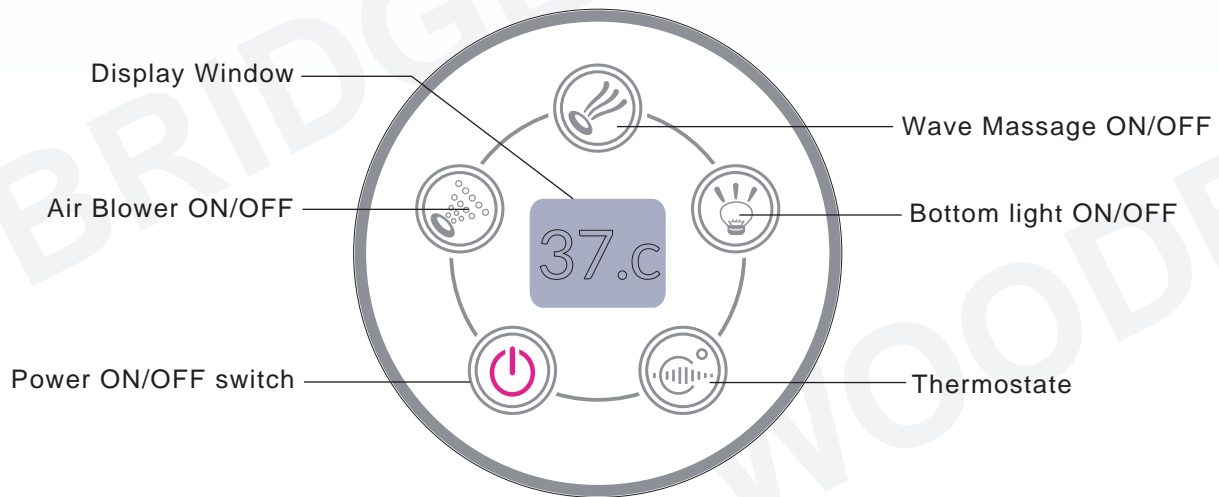
## 4. Schematic diagram of the panel

**BJ400 BJ700**



- (1) Press the Power switch , to turn on the power.
- (2) Press the Bottom Light , switch to turn on and off the lights.
- (3) Press the Air Blower , to turn on and off the air blower.
- (4) Press the Wave massage , switch to activate the whirlpool feature, repeat the same operation to end the feature.
- (5) With sufficient water inside the tub, press water pump switch then press thermostate , switch to turn on the heater, repeat the same operation to turn off thermostat function.
- (6) Under thermostat cycle, long press Thermostat switch to get into water temperature setting mode, When Thermostat icon blinking, continue to press till desired temperature then release, blinking will continue for few seconds then stop and temperature display will show current water temperature. When setting temperature is reach, heater will automatically stop running but when water get colder and is below the setting temperature, the motor will resume and operating.

**\*\* DO NOT Power on the water pup if there is no enough water inside the tub.**

**\*\* The setting temperature range is between 86°F to 122°F (30°C - 50°C)**



## 5. Operating Environment

- (1) Power: AC 110V
- (2) Bottom Lights: AC 12V
- (3) Wave massage, Air Blower: AC 110V
- (4) Heater: AC 110V

## 6. Caution

1. Carefully read this user manual before you operate this unit and keep this user manual for future reference.
2. Be aware of the high voltage warning labels on the unit, do not touch it.
3. DO NOT long time expose control panel under wet, heat conditions, keep it away from any high frequency equipment. Clean it with dry cloth after use.
4. ALWAYS keep clean water inside the tub because dirty water include debris that will damage the tub components and clogged the water way inside the tub. Should there be a clogged, turn off the pump immediately and remove the clog.
5. DO NOT pull any of connection cords and slam the unit, this may cause damage or malfunction.

## 7. Basic Trouble Shooting

1. Q: why do not thermostat heating run?

A: Check whether you adjust the temperature of control panel to the water temperature or higher at room temperature.

2. Q: Press lights, ozone, speakers, fan, air-conditioning and other functions, but why don't they start to run?

A: check whether the plug-in terminals contacts with each other well ; if lights and ozone sterilization still fails to run, please turn on the fuse and ensure if it has blew out then you can contact with my company staff.

Pull out and disconnect the plug for mininum 3 seconds reconnect the plug



Woodbridge warrants its products as listed in below to be free of material and workmanship defect, subjected to the limitations set forth in this limited warranty.

- Bathtub, Whirlpool/Air Bubble Massage Tub: 1 Year limited to be free of defects in material and workmanship
- Toilet and Bidet: 1 Year limited to be free of defects in material and workmanship
- Faucet: 1 Year limited to be free of defects in material and workmanship
- Vanity: 1 Year limited to be free of defects in material and workmanship
- Granite, Marble, Engineered Quartz Vanity Top: 1 Year limited to be free of defects in material and workmanship
- Medicine Cabinet, LED Mirror: 1 Year limited to be free of defects in material and workmanship
- Stainless Steel Sink: 1 Year limited to be free of defects in material and workmanship
- Solid Surface Shower Wall Panel, Shower Base and Vanity Top: 10 Years limited warranty to be free from material defects
- Shower Door: Lifetime warranty on glass components and 1Year limited on other hardware

This limited warranty is non-transferable and only applies to products purchased and installed in the United States.

This limited warranty excludes all industrial, commercial and business usage. Proof of purchase (original sales receipt) from the original purchaser, Description and pictures of defect, model number or model description must be provided to Woodbridge Bath for all warranty claims and Woodbridge Bath IS NOT responsible for labor cost, removal or installation costs.

This limited warranty shall not apply to goods which have been subject to accident, negligence, improper installation, product abuse, product misuse, or use of cleaners containing abrasives, alcohol or other organic solvents, whether performed by a contractor, service company, or yourself, are excluded from this warranty.

This warranty does not cover surface damaged caused by use of chemicals that break through or dissolve the surface finish or damage caused by the accidental dropping of sharp or heavy objects. Improper care and use of abrasive cleaners and will void the warranty.

During this limited warranty period if a malfunction occurs and after inspection it is determined that a defect developed during normal use, Woodbridge will as at its election proceed with any of the following options:

- (1) repair or replace the defective part(s) or product(s) at cost
- (2) issue a refund of the original purchase price of the product(s) (Valid within 30 days from the date of purchase)
- (3) issue a credit to be applied toward the purchase of a new product. Shipping/delivery charges may apply and are in sole discretion.

**Caution:**

NEVER use cleaners containing abrasive cleaners, ammonia, bleach, acids, waxes, alcohol, solvents or other products that are not recommended for Chrome finish will void the warranty.

Woodbridge products should be installed by a fully insured and licensed contractor only. Installation by anyone other than fully insured and licensed contractor will void this limited warranty.

### RESPONSIBILITIES OF OTHERS

Inspecting the unit prior to installation is the responsibility of the installer or building contractor who acts on behalf of the user. They are responsible for ensuring the unit is free of defect or damage. Notices are placed on the unit and on the shipping carton advising the installer of this responsibility. In the event of a problem, the unit must not be installed. Woodbridge is not responsible for failures or damage that could have been discovered, repaired, or avoided by proper inspection and testing prior to installation.

Damage occurring in transit is the responsibility of the carrier. The user or installer MUST open the crate and inspect the unit for damage when it is delivered. If damage is discovered, it must be reported immediately to the seller and the carrier in writing, and an inspection requested. Failure of the carrier to respond should be reported to the seller and the carrier. Your freight claims should be filed promptly thereafter.

This limited warranty does not cover any liability for consequential or incidental damages, all of which are hereby expressly disclaimed, or the extension beyond the duration of this limited warranty of any implied limited warranties, including those of merchantability or fitness for an intended purpose.

### DISCLAIMER

Except as expressly provided, there shall be no warranty or obligation, express or implied, oral or statutory. No dealer or other person has the authority to make any warranties or representations concerning or its products. In no event shall be held responsible for any such warranties or representations.

Some states/provinces do not allow limitations on how long an implied warranty lasts, or the exclusion or limitation of special, incidental or consequential damages, so these limitations and exclusions may not apply to you. This warranty gives you specific legal rights, you may also have other rights which vary from state/province to state/province.

To obtain warranty and replacement parts, please send e-mail to [help@woodbridgebath.com](mailto:help@woodbridgebath.com) with the original receipt information, Woodbridge will determine whether to repair or replace your product, issue a refund or issue a credit.

### WOODBIDGE®

15600 Blackburn Ave.,  
Norwalk, CA 90650 USA

(Monday - Friday 9 AM - 5 PM Pacific Standard Time)

Email: [help@woodbridgebath.com](mailto:help@woodbridgebath.com) (Prefer by e-mail)  
Customer Service Phone: 562-229-0088



## IMPORTANT SAFETY RULES

**ATTENTION!** ALWAYS FOLLOW THESE PRECAUTIONS WHEN USING A BATHTUB

- ⚠ Warning** The bathtub must be installed and used as described in this manual
- ⚠ Warning** Use caution when entering or exiting the bathtub
- ⚠ Warning** Do not permit children or persons with infirmities to use the bathtub without supervision of an adult
- ⚠ Warning** People using any medications or having adverse medical history must consult a physician prior to use of the bathtub to avoid potential hyperthermia and possible drowning
- ⚠ Warning** Water temperature over 100°F may cause hyperthermia and/or other health problems. Check water temperature and adjust it for your personal comfort
- ⚠ Warning** Never use bathtub while intoxicated, after taking meals or any alcoholic beverages. Consuming alcoholic beverages before or during bathing will cause drowsiness and may result in hyperthermia, loss of consciousness, or even drowning
- ⚠ Warning** If you are pregnant or you feel that you are may be pregnant, consult your doctor before using the bathtub
- ⚠ Warning** Never use any electrical devices such as hair dryer, lamp, telephone, tv, radio, or others within 5 feet of the bathtub
- ⚠ Warning** Do not overfill the bathtub before enetering. Entering the bathtub when filled will cause overflow and slippery conditions. Use extreme caution when entering and exiting

## Care and Cleaning

- Most dirt will wash off with mild soap and warm water.
- For tough spots, use liquid dish washing soap or non-chlorine bleach.
- Do not use abrasive material such steel wool or scouring pads to clean the acrylic surface.
- Always test the cleaning solution on a small area before using it on the entire surface.
- Do not allow cleaning to soak on the acrylic surface.
- Rinse thoroughly with water immediately and wipe dry with soft cloth.

## Repair and Maintenance

- Use liquid polish compound such as Gel-Gloss Kitchen and Bath Polish(TM) to keep the original shine of acrylic surface.
- Light scratches can be removed with polishing compound for automobiles.
- For deeper scratches use wet sandpaper (1500 grit or higher). Always add water when sanding and lightly sand the area larger than the scratch in a circular motion to remove the scratches. Repeat until the scratch is removed. Use soft cloth and small amount of polishing compound to restore shine. Repeat as needed until surface shine is restored.

### IMPORTANT!

**DO NOT USE:** Abrasive cleaners such as: acid, ammonia, bleach, and similar solutions. Use of such solutions may cause corrosion, finish peeling, and/or dull the surface.

**DO NOT USE:** Abrasive sponges or cloth. Never use steel, wool, or wired brushes that will permanently scratch the surface.

**Retain these installation instructions for future reference!**

Thank you for using WoodBridge products!

Please don't hesitate to contact us if you have any questions or concerns.

Customer Service Phone: 562-229-0088. (Monday - Friday 9 AM - 5 PM Pacific Time)

Or Email: [help@woodbridgebath.com](mailto:help@woodbridgebath.com)

