

CONTENTS OF SHIPPING CARTON

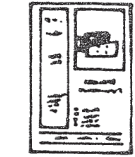

No. A L-1523-I
Owner's Manual
1 Used



No. B Z-1428-C
Hardware Bag
1 Used



No. 7 B-2596
Blade Mount Plate
1 Used



No. 22 B-4814-10
Side Plate
2 Used

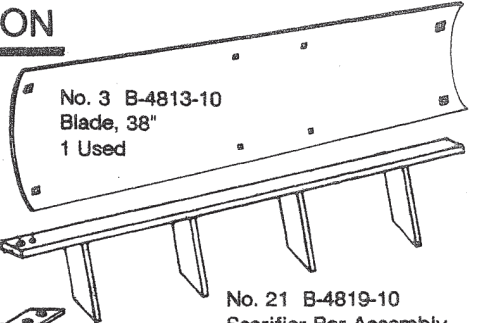

No. 3 B-4813-10
Blade, 38"
1 Used

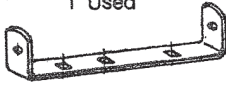

No. 28 B-5344-10
Weight Support Bracket
1 Used



No. 25 B-5693-10
Hold Down Strap
1 Used

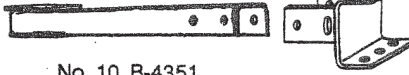

No. 10 B-4351
Drawbar Assembly
1 Used

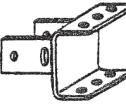

No. 9 B-4265
Hitch Assembly
1 Used

No. 21 B-4819-10
Scarifier Bar Assembly
1 Used

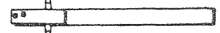

No. 4 B-2376
Angling Lever
1 Used

No. 27 B-5343-10
Weight Mount Bracket
2 Used

Z-1428-C HARDWARE BAG (ACTUAL SIZE)

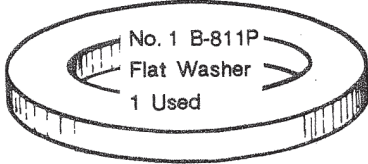

No. 1 B-811P
Flat Washer
1 Used



No. 20 50M0416
Cotter Pin
1/8" x 1"
1 Used



No. 14 30M1200P
Hex Nut, 3/8"
7 Used



No. 2 B-1675P
Hex Lock Nut
3/8"
1 Used

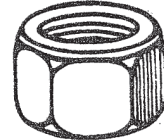

No. 15 30M1600P
1/2" Hex Nut
4 Used

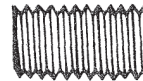

No. 13 10M1240P
Carriage Bolt
3/8" x 2-1/2"
1 Used

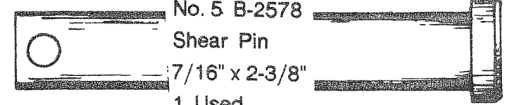
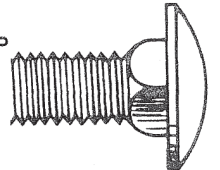

No. 5 B-2578
Shear Pin
7/16" x 2-3/8"
1 Used

Z-1516-1 HARDWARE BAG (ACTUAL SIZE)

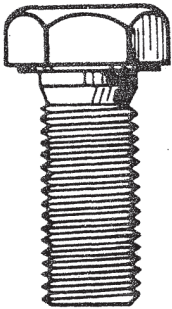

No. 11 2M1620P
1/2" x 1-1/4" Hex Bolt
4 Used

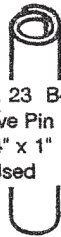

No. 23 B-671
Drive Pin
1/4" x 1"
1 Used

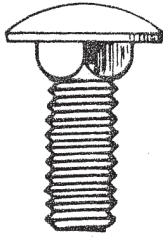

No. 12 10M1216P
Carriage Bolt
3/8" x 1"
8 Used

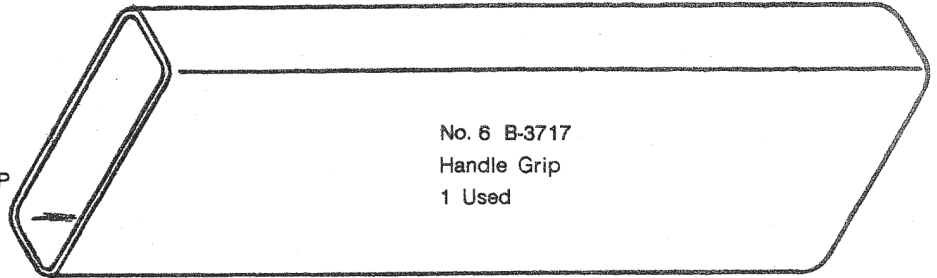

No. 6 B-3717
Handle Grip
1 Used

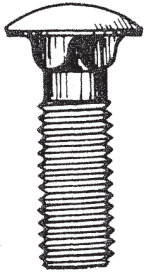

No. 16 40M1200P
Lock Washer, 3/8"
11 Used



No. 17 45M1313P
Flat Washer, 3/8"
6 Used



No. 18 40M1600P
1/2" Lock Washer
4 Used



No. 19 45M1717P
1/2" Flat Washer
2 Used

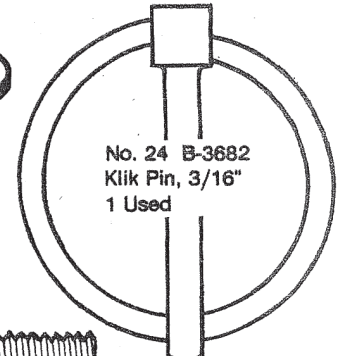

No. 24 B-3682
Klik Pin, 3/16"
1 Used

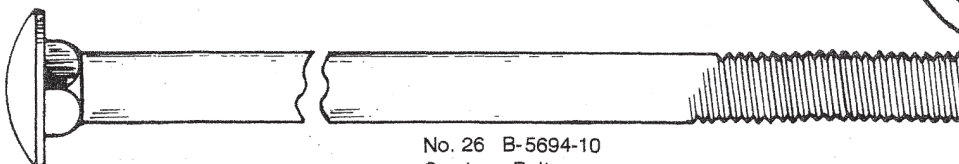

No. 26 B-5694-10
Carriage Bolt
3/8" x 8-1/2"
1 Used



No. 14 30M1200P
Hex Nut, 3/8"
4 Used

No. 29 10M1220P
Carriage Bolt,
3/8" x 1-1/4"
2 Used