



PIONEER INDUSTRIES, INC.
 3325 S. Garfield Ave
 Commerce, CA 90040
 (800) 338-9468
 www.pioneerind.com

INSTALLATION

Tools:



Model Number: 2AM600, 2MT600

Warnings and Notes:

Check with local plumbing code requirements before installation.
 This product should be installed by a local listed plumber.
Do not use plumbers putty on threads.

Installation Steps:

Wallmount Pot Filler

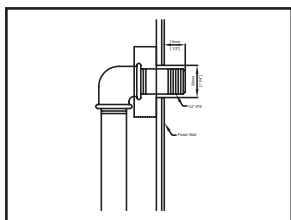

(1) Confirm the 1/2" IPS/NPT threaded inlet pipe nipple must be kept with a length of 1/2" from the finished wall.

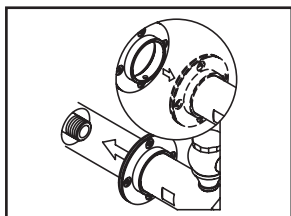

(2) After wall is finished install the pot filler to the 1/2" IPS/NPT threaded inlet pipe nipple. Do not fully tighten.

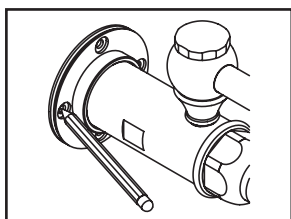

(3) Level the pot-filler. Mark the drilling hole location on the finished wall. Space remove the pot filler.

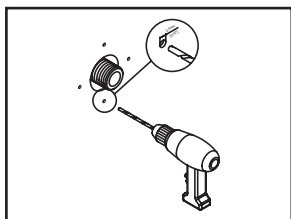

(4) Drill the four 3/32" holes on the premarked location

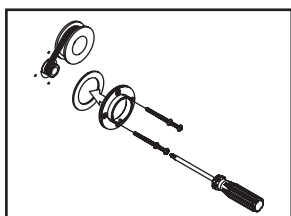

(5) Apply Teflon tape to thread end of inlet pipe nipple before installing the mounting bracket. Put the mounting washer on the wall and drill the 3/32" hole on the same location as wall. Ensure the mounting washer is behind the mounting bracket to form the watertight seal. Install the mounting bracket with the mounting screws supplied with faucet. Tighten the mounting screws.

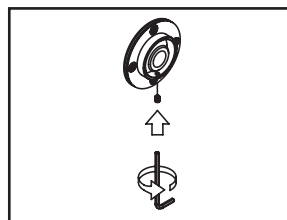

(6) Remove the 3/32" Allen screw

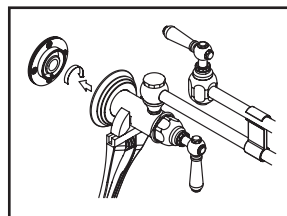

(7) Carefully screw the pot-filler into inlet pipe nipple using adjustable wrench to fully tighten the pot filler. Ensure the notches on the faucet align with the 3/32" Allen screw. Level the pot filler. Tighten the 3/32" Allen screw.

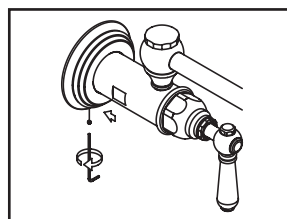

(8) Place the escutcheon in correct position. Tighten the 1/16" Allen screw

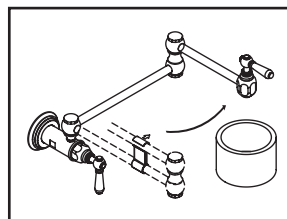

(9) Make sure the pot filler spout swivels smoothly. Place a bucket underneath of the pot-filler. Remove the aerator.

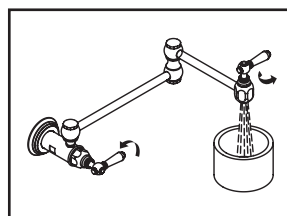

(10) Turn on inlet water supply. Make sure all the connections are secure. Open both handles. Flush and allow water to run at full flow for at least one minute. Turn off water and replace the aerator.

Exploded Drawing (2AM600)

* Note: Please specify finish/color when ordering.

	ITEM #	DESCRIPTION
A	X-1200010*	Lever Handle
B	X-4200093*	Handle Sleeve
C	X-4200067*	Handle Escutcheon
D	X-3200004H	Ceramic Cartridge
E	X-4900041*	2.0 GPM Aerator
F	X-1200009*	Lever Handle
G	X-4200064*	Escutcheon
H	X-5200010	Mounting Kit
I	X-4900040	1/16" Allen Wrench
J	X-4900024	3/32" Allen Wrench
1	X-4900042P*	Handle Button-Plain
2	X-4900043	Handle Screw
3	X-4200065	Handle Screw
4	X-4900039	1/16" Allen Screw
5	X-4900002	3/32" Allen Screw

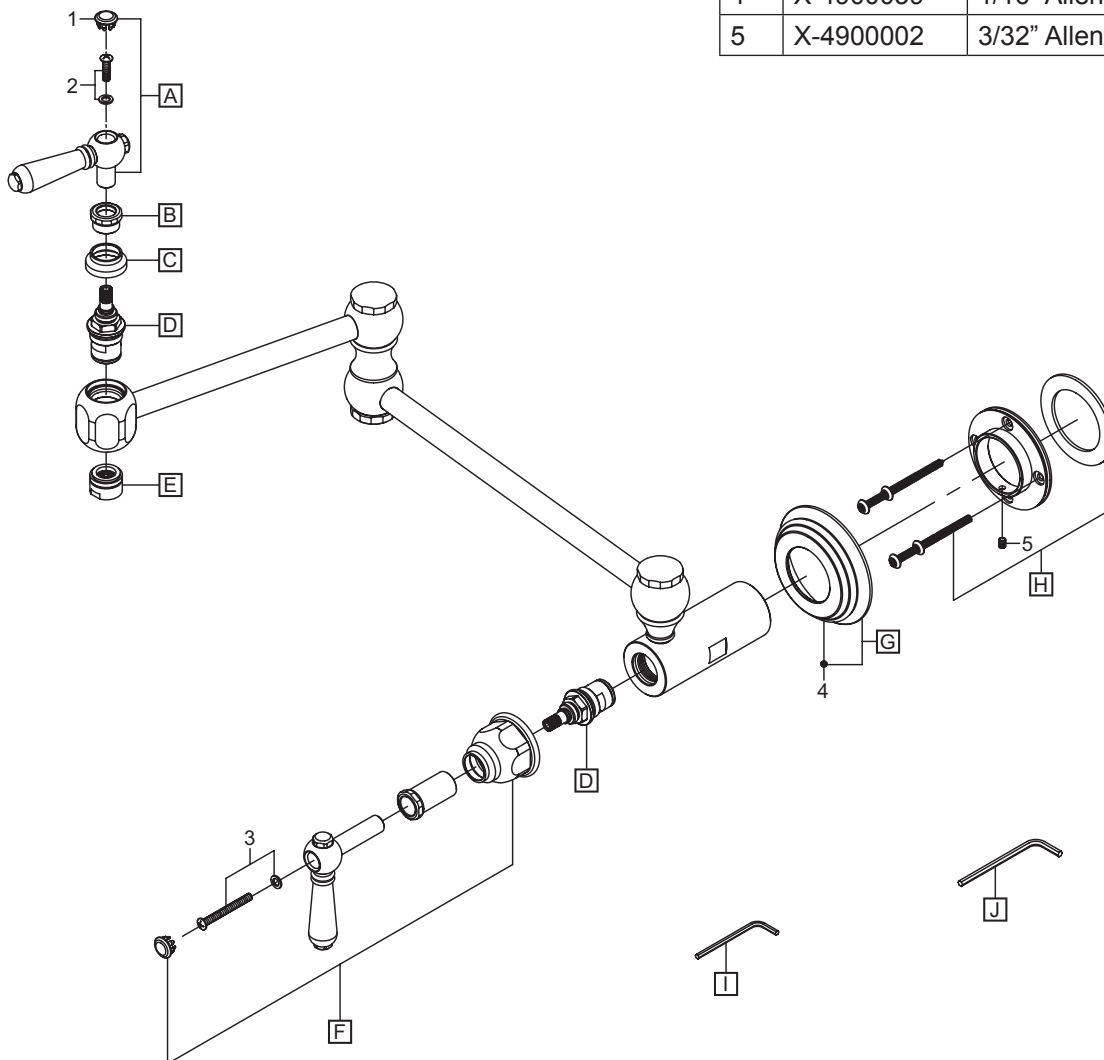

For more care information or trouble shooting inquiries about your Pioneer product, please call:
Pioneer Industries, Inc. (800) 338-9468
 Monday-Friday 8AM to 8PM EST (5AM to 5PM PST)
www.pioneerind.com

Exploded Drawing (2MT600)

* Note: Please specify finish/color when ordering.

	ITEM #	DESCRIPTION
A	X-1200018*	Lever Handle
B	X-3200004H	Ceramic Cartridge
C	X-4200153	Gasket
D	X-4900041*	2.0 GPM Aerator
E	X-1200021*	Lever Handle
F	X-4200158*	Escutcheon
G	X-5200010	Mounting Kit
H	X-4900040	1/16" Allen Wrench
I	X-4900024	3/32" Allen Wrench
1	X-4900002	3/32" Allen Screw
2	X-4400073*	Hole Cover
3	X-4900039	1/16" Allen Screw

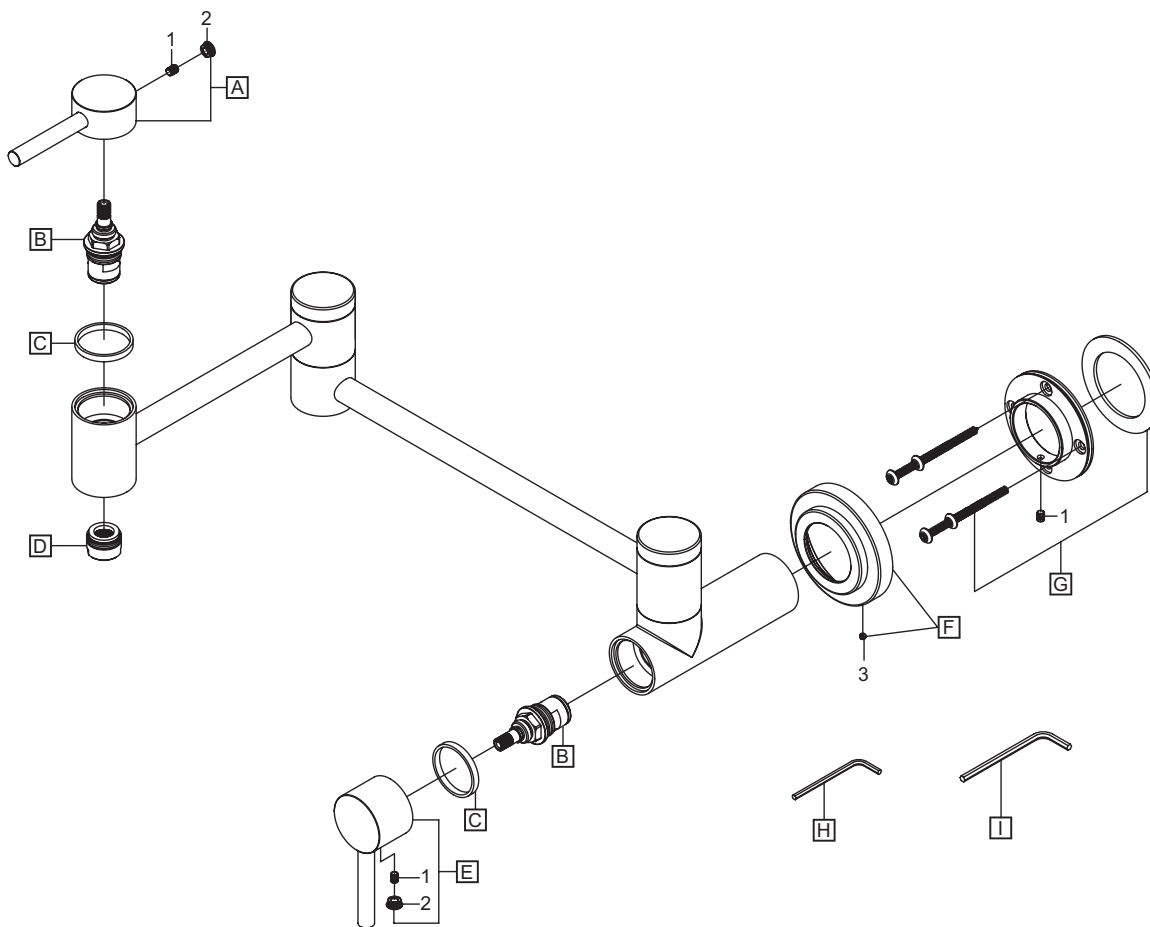

For more care information or trouble shooting inquiries
 about your Pioneer product, please call:
Pioneer Industries, Inc. (800) 338-9468
 Monday-Friday 8AM to 8PM EST (5AM to 5PM PST)
www.pioneerind.com