



TB-1000PS

12.5 cu ft POLY SWIVEL DUMP CART



READ AND FOLLOW ALL SAFETY RULES AND OPERATING INSTRUCTIONS BEFORE USING THIS EQUIPMENT

Carton Contents

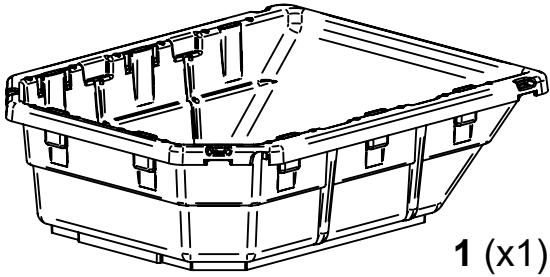

1 (x1)

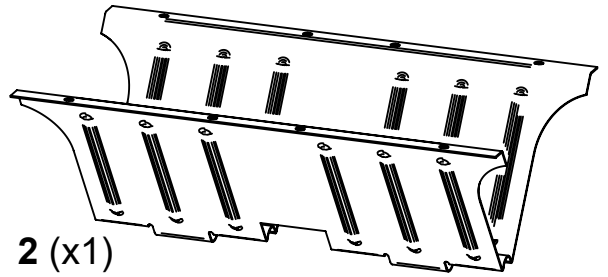

2 (x1)

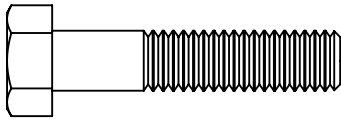

3 (x12)



4 (x12)

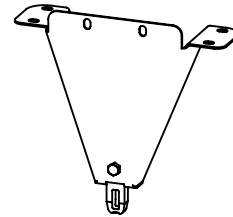

5 (x1)



6 (x1)

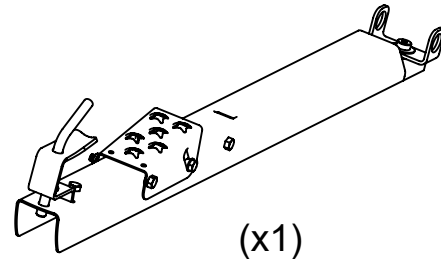

(x1)

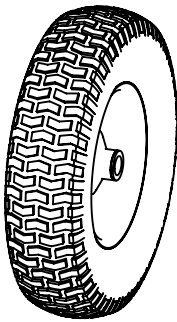

22 (x2)

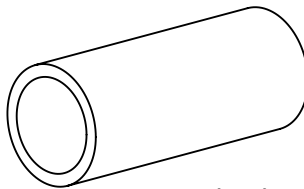

23 (x1)

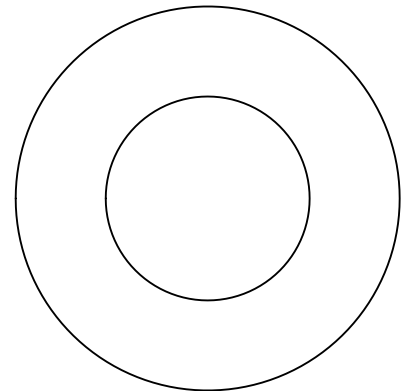

24 (x4)

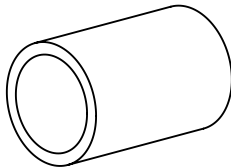

25 (x2)

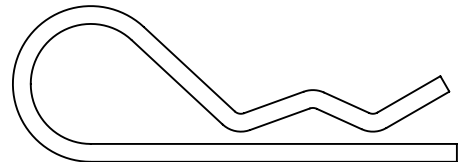

26 (x2)

TOOLS REQUIRED FOR ASSEMBLY:

- 1/2" Wrench or Socket
- Grease Gun

EXPLODED VIEW

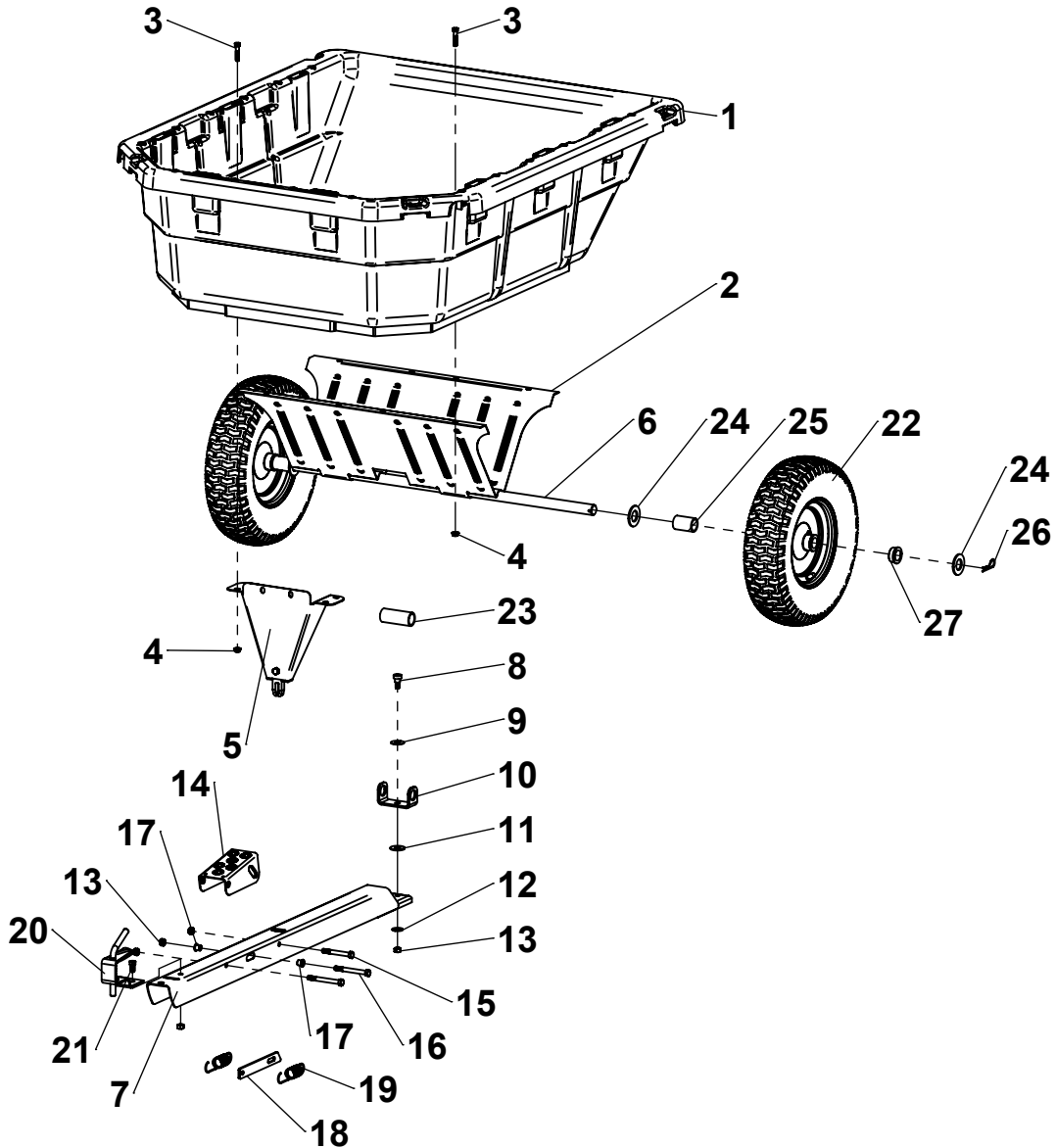

ITEM	PART NO	DESCRIPTION	QTY	ITEM	PART NO	DESCRIPTION	QTY
1	311161	POLY BODY	1	15	KIT 6001663-BR	3/8-16 x 3" HEX BOLT	1
2	6000404-B2	UNDERCARRIAGE	1	16		3/8-16 x 3-1/2" HEX BOLT	2
3	KIT 6004321	5/16-18 x 1-1/2" HEX BOLT	12	17		BUSHING	2
4		5/16-18 LOCK NUT	12	18		LATCH	1
5	6000310-B2	Front Support	1	19		LATCH SPRING	2
6	300002	AXLE	1	20		SPRING LOADED HITCH	1
7	KIT 6001663-BR	WELDED DRAWBAR	1	21		3/8-16 x 3/4" HEX BOLT	1
8		SHOULDER BOLT	1	22	6002415-1-C	WHEEL (BUSHINGS INC.)	2
9		SPRING WASHER	1	23	KIT 6004324	3-1/8" SPACER	1
10		SWIVEL CLEVIS	1	24		1" SAE FLAT WASHER	4
11		1/2" USS WASHER	1	25		2" SPACER	2
12		3/8" USS FLAT WASHER	1	26		HAIRPIN COTTER, 2-5/16"	2
13		3/8-16 C-LOCK NUT	5	27	KIT 6000810	REPLACEMENT BUSHINGS (SET OF 4)	-
14		FOOT PEDAL	1				