



## 4 in. Dryer Vent Kit with Hood



### PRODUCT SPECIFICATIONS:

- Polypropylene molded plastic
- Opening/closing damper prevents outside elements from entering the vent
- Removable pest screen
- Paintable surface to match the accents of the house
- Snap-in removable 1/2" x 1/2" pest grid screen (birdguard)  
*Check screen frequently for lint build-up.*



FLUSH  
WITH SCREEN

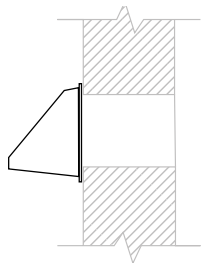
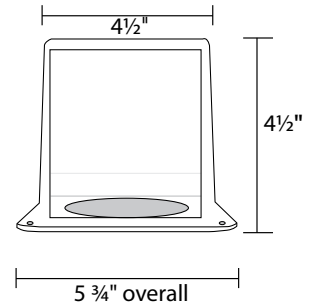
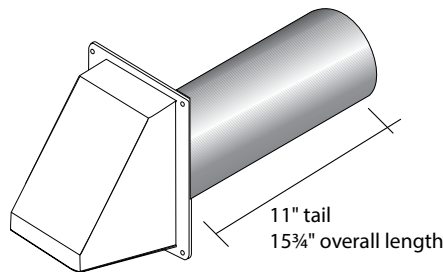

FLUSH

Flush (faceplate only)

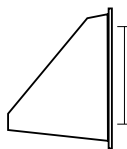

4" Tailpipe  
Opening

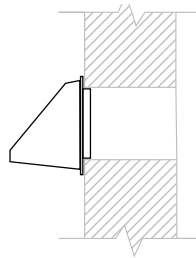

WITH CONNECTING RING

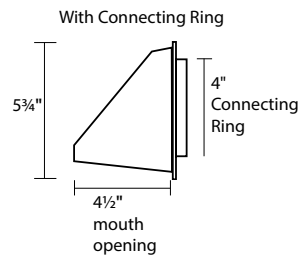

Aluminum Trim Ring  
5 5/8" x 5 5/8"  
square

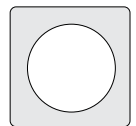

4" hood has 4"  
diameter hole

