

1/2" Schedule 40 PVC Pipe

SPECIFICATIONS

Product SKU: P012FGP

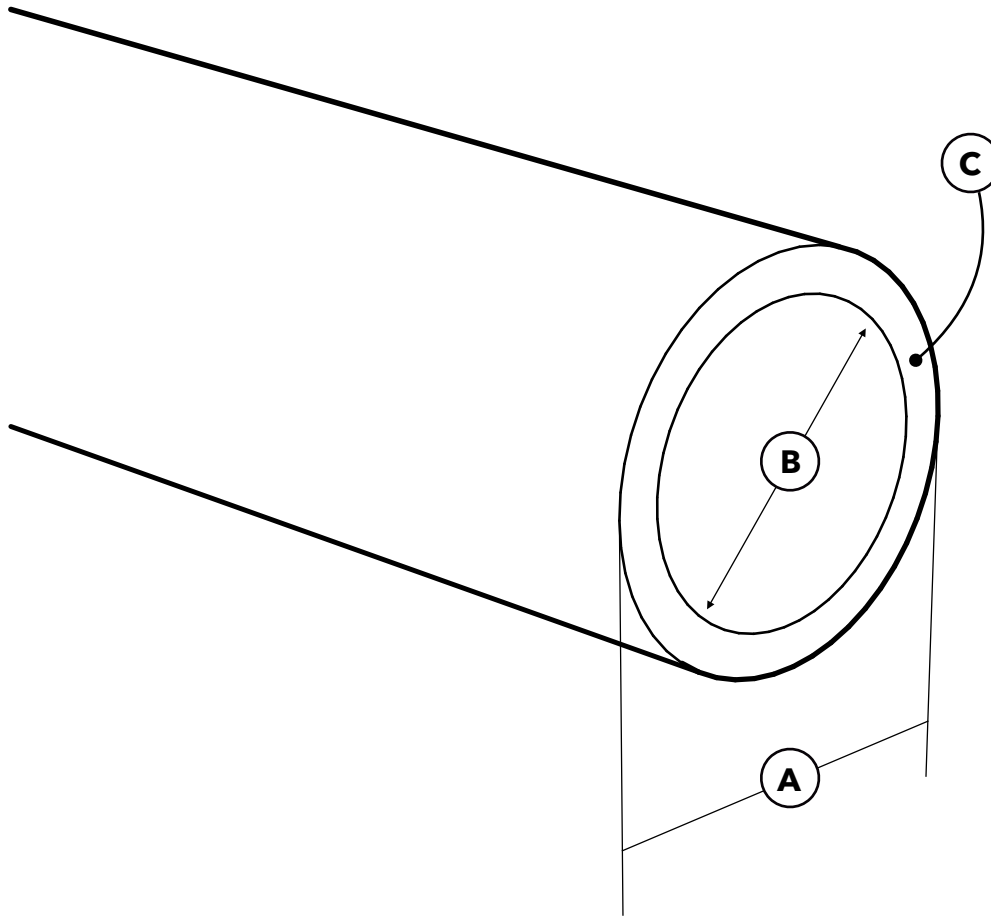

ID	Description	Dimension
A	Outside Diameter	0.840 in.
B	Avg. Inside Dia.	0.622 in.
C	Min. Wall Thickness	0.109 in.
	Weight	0.150 lb./ft.
	Schedule	40

NOTICE: All information within this Technical Specifications document is accurate at the time of document date. Product specifications and/or appearance may change.

