

Home Decorators

— Collection —

BF-20191 HAMPTON BAY 4 DOOR CABINET

ASSEMBLY INSTRUCTIONS



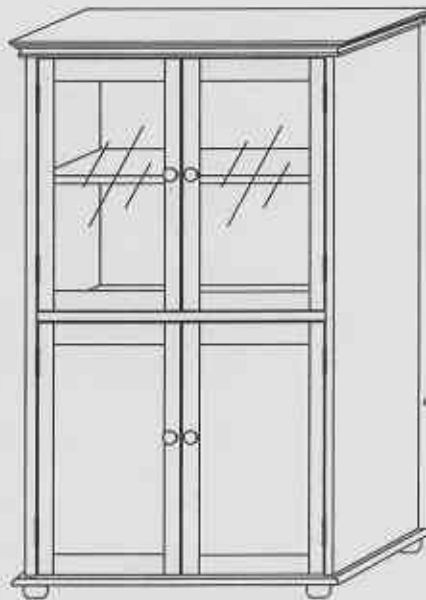





Made In China

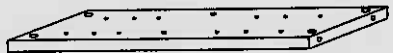
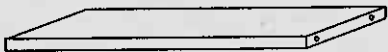
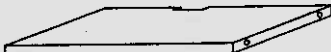

Thank you for purchasing this quality product. Be sure to check all packaging material carefully for small parts, which may have loose inside the carton during shipment. Once unpacked, compare all parts and hardware to the provided list to be sure all parts are present. If any parts or hardware are missing or damaged, please phone, e-mail or fax our Customer service Department. For speedy service, please provide your order number, item number and part number/letter of the part needed.

IMPORTANT NOTE: Follow instructions listed below in proper sequence as numbered to assure fast, easy and correct assembly.

PARTS LIST

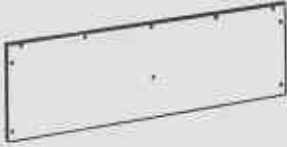
<p style="text-align: center;">A</p>  <p style="text-align: center;">BOTTOM PANEL-1PC</p>	<p style="text-align: center;">B</p>  <p style="text-align: center;">FEET -4PCS</p>	<p style="text-align: center;">C</p>  <p style="text-align: center;">LEFT SIDE PANEL-1PC</p>
<p style="text-align: center;">D</p>  <p style="text-align: center;">RIGHT SIDE PANEL-1PC</p>	<p style="text-align: center;">E</p>  <p style="text-align: center;">ACROSS PANEL-1PC</p>	<p style="text-align: center;">F</p>  <p style="text-align: center;">TOP PANEL-1PC</p>
<p style="text-align: center;">G</p>  <p style="text-align: center;">LEFT DOOR-1PC</p>	<p style="text-align: center;">H</p>  <p style="text-align: center;">RIGHT DOOR-1PC</p>	<p style="text-align: center;">I</p>  <p style="text-align: center;">LEFT DOOR-1PC</p>
<p style="text-align: center;">J</p>  <p style="text-align: center;">RIGHT DOOR-1PC</p>	<p style="text-align: center;">K</p>  <p style="text-align: center;">REAR PANEL GUIDE-1PC</p>	<p style="text-align: center;">L</p>  <p style="text-align: center;">BACK PANEL-2PCS</p>

M

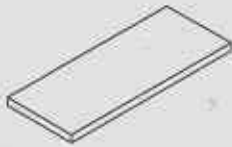

SHELF-2PCS

N



CAM BOLTS-12PCS

O



CAM LOCKS-12PCS

P



SCREWS-3PCS

Q



LARGE MAGNET-2PCS

R



SCREWS-28PCS

S



SCREWS-52PCS

T

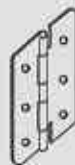

HINGE-8PCS

U



FEMALE MAGNETS-4PCS

V



KNOB-4PCS

W



SCREWS-4PCS

X



SHELF SUPPORT-8PCS

Y



SCREWS-4PCS

Z



CAM-TOOL-1PC

A1



ALLEN WRENCH-1PC

NOTE: • UPON OPENING THOROUGHLY CLEAN ALL WOODS SURFACES TO REMOVE DUST AND DIRT THAT MAY HAVE SETTLED ONTO FINISH DURING SHIPMENT. IN ORDER TO PREVENT DAMAGE DURING ASSEMBLY, PLEASE ASSEMBLE THIS ITEM WITH AT LEAST TWO PEOPLE.

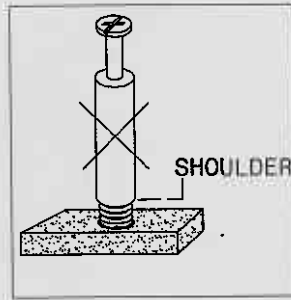
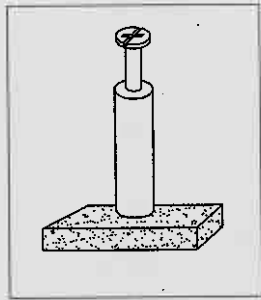

NOTE: TURN THE CAM-BOLT SCREWS UNTIL THEY ARE TIGHT, THE SHOULDER SHOULD BE AGAINST THE SURFACE OF THE PART.

HOW TO USE THE CAM-TOOL

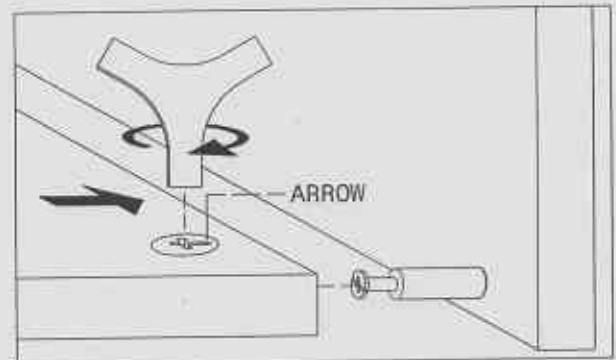
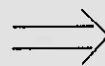
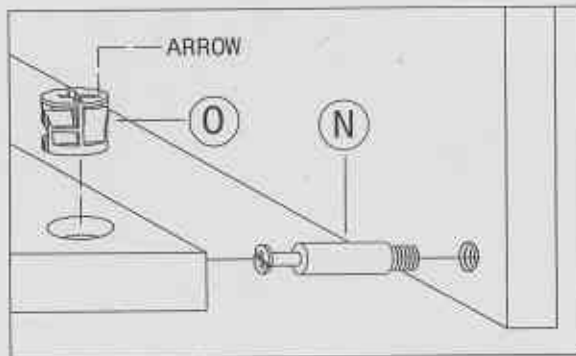

NOTE: • THE ARROWS ON THE HIDDEN CAM-LOCKS SHOULD POINT TO THE CAM-BOLTS

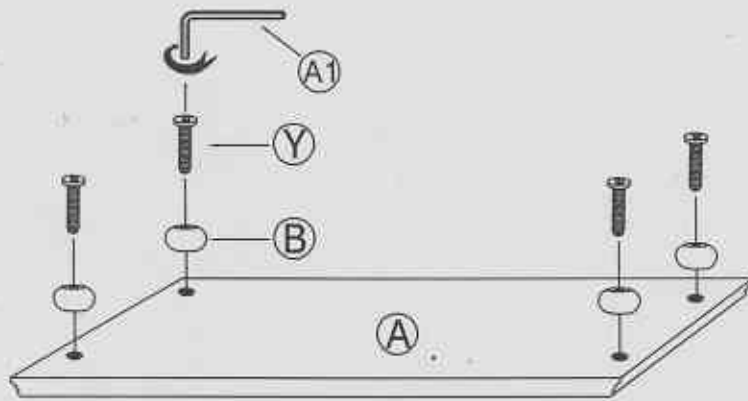

1) . ASSEMBLE THE FEET(B) .

- ATTACH THE FEET(B) TO BOTTOM PANEL (A) USING SCREWS (Y) .

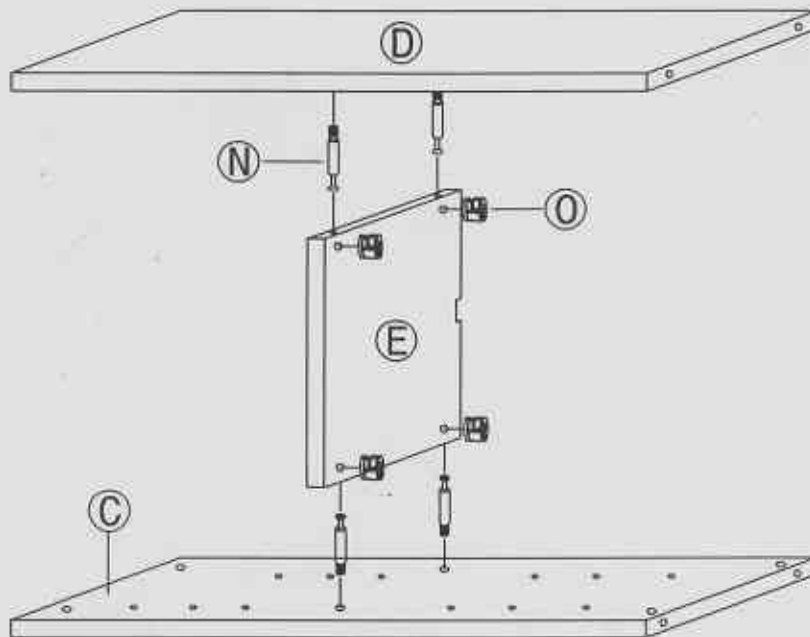

2) . ASSEMBLE THE SIDE PANEL (C/D) .

- ROTATE THE CAM-BOLTS (N) INTO HOLES IN SIDE PANEL (C/D) .
- PLACE THE CAM-BOLTS (N) INTO HOLES IN PANEL (E) AND ATTACH USING CAM-LOCKS (O) .

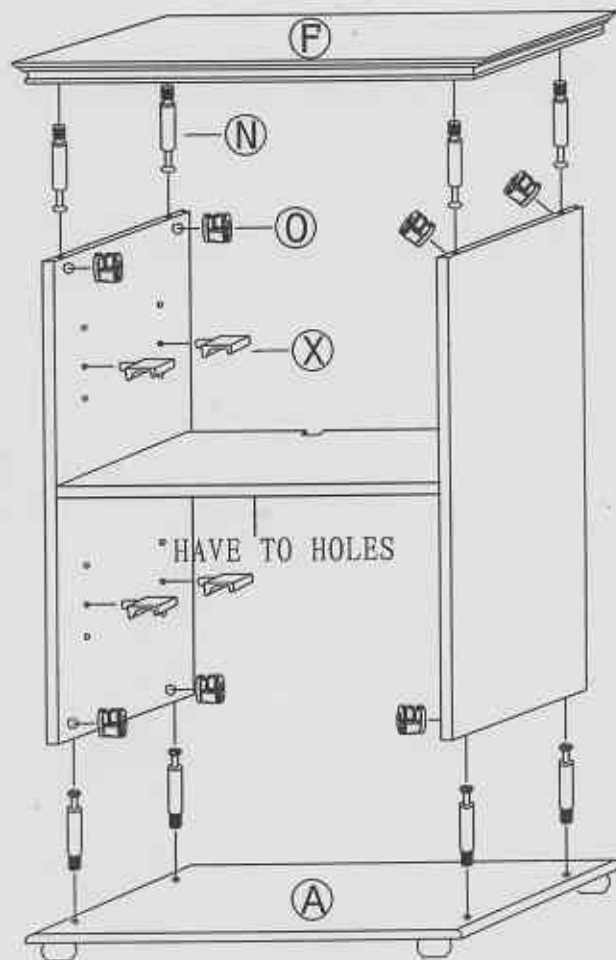

3) . ASSEMBLE THE TOP/BOTTOM PANEL (F/A) .

- ROTATE THE CAM-BOLTS(N) INTO HOLES IN TOP/BOTTOM PANEL (F/A) .
- PLACE THE CAM-BOLTS(N) INTO HOLES IN PANEL (C/D) AND ATTACH USING CAM-LOCKS (O) .
- INSERT THE SHELF SUPPORT (X) INTO THE HOLES OF THE SIDE PANEL (C/D) .

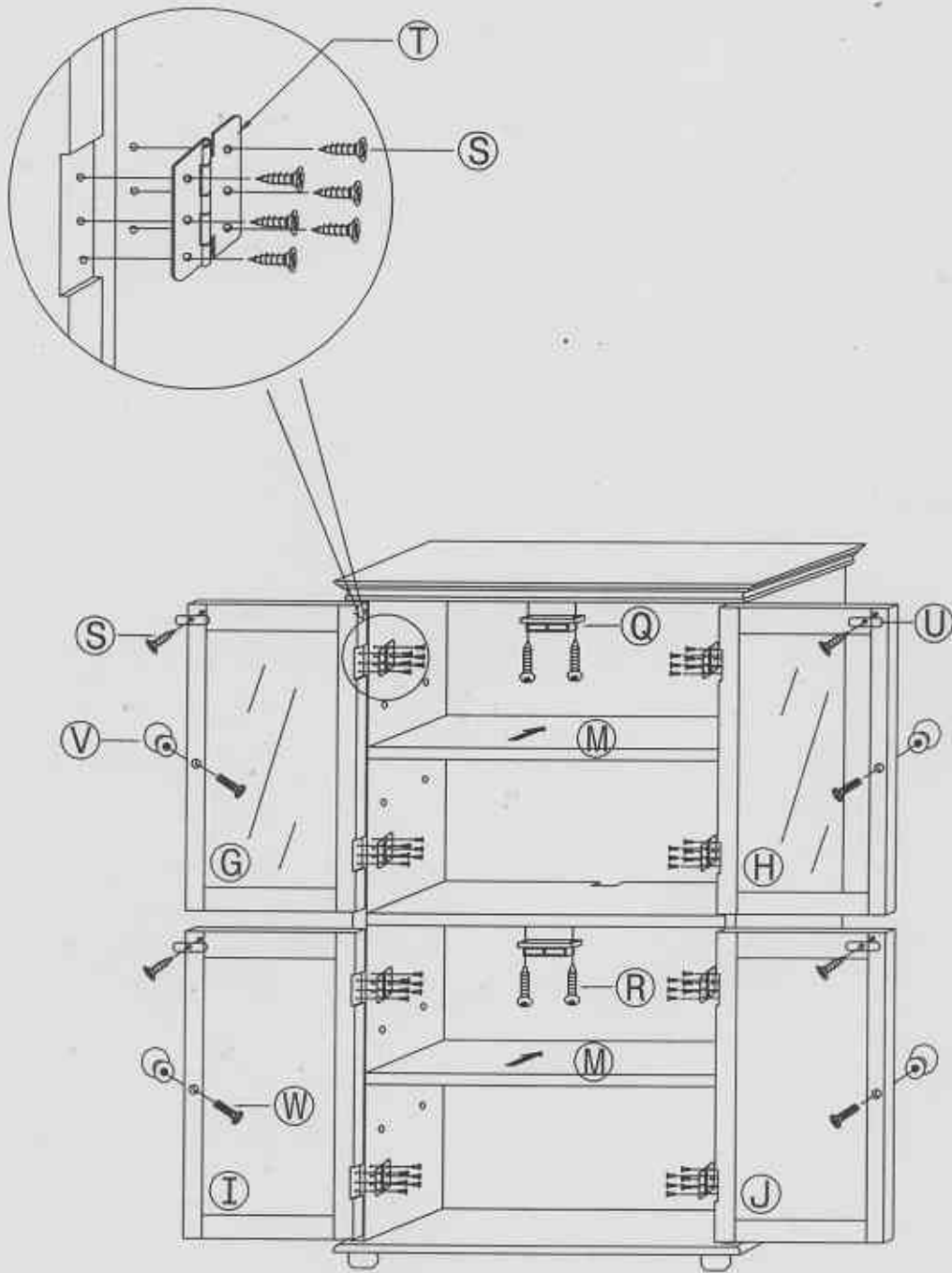

4) . ASSEMBLE THE DOORS(G/H/I/J)AND SHELF(M) .

- ATTACH THE 8 HIGNES(T)TO DOORS(G/H/I/J)AND SIDE PANEL(C/D)USING SCREWS(S) .
- ATTACH THE FEMALE MAGNETS(U)TO THE DOORS(G/H/I/J)USING SCREW(S) .
- ATTACH THE KNOB(V)TO THE DOORS(G/H/I/J)USING SCREWS(W) .
- ATTACH LARGE MAGNET(Q)TO TOP PANEL(A)AND ACROSS PANEL(E)USING SCREWS(R) .
- FINALLY ,PUT SHELF(M)ONTO SHELF SUPPORT(X) .

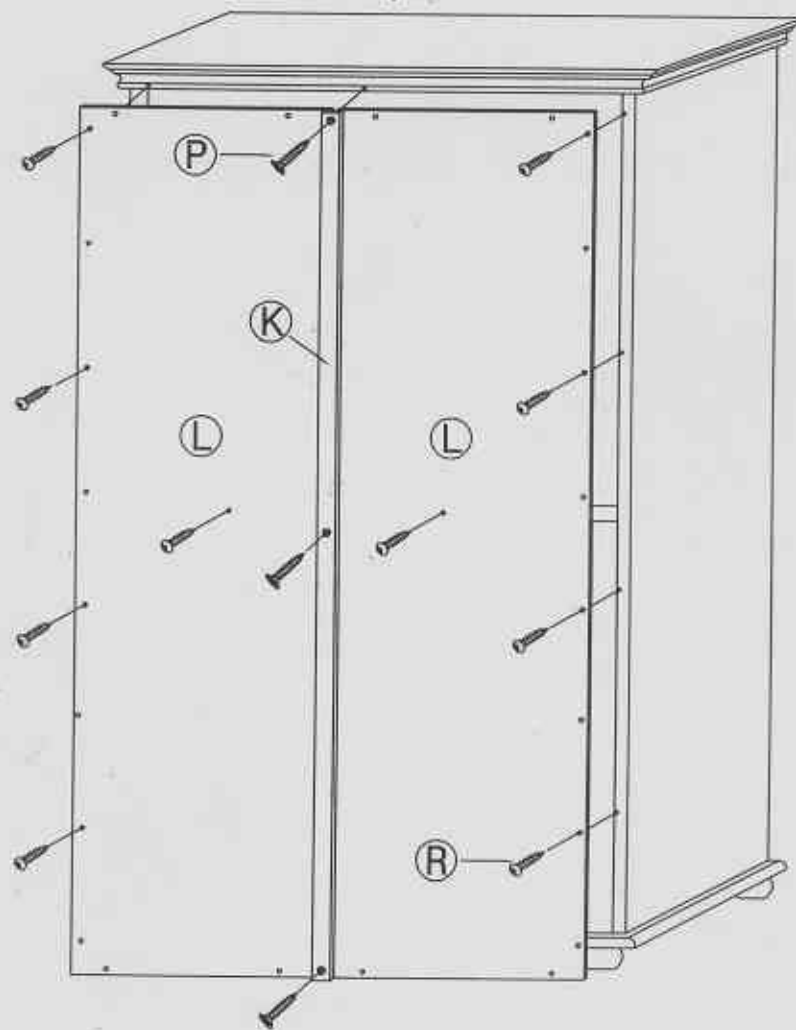

5) . ASSEMBLE THE BACK PANEL (L) .

- INSERT THE BACK PANEL (L) INTO SLOT IN REAR PANEL GUIDE (K) .
- ATTACH THE BACK PANEL (L) AND REAR PANEL GUIDE (K) USING SCREWS (R/P) .