

VISSANI™

SKU #1007086606

Model #VWA05

USE AND CARE GUIDE

WINDOW AIR CONDITIONER

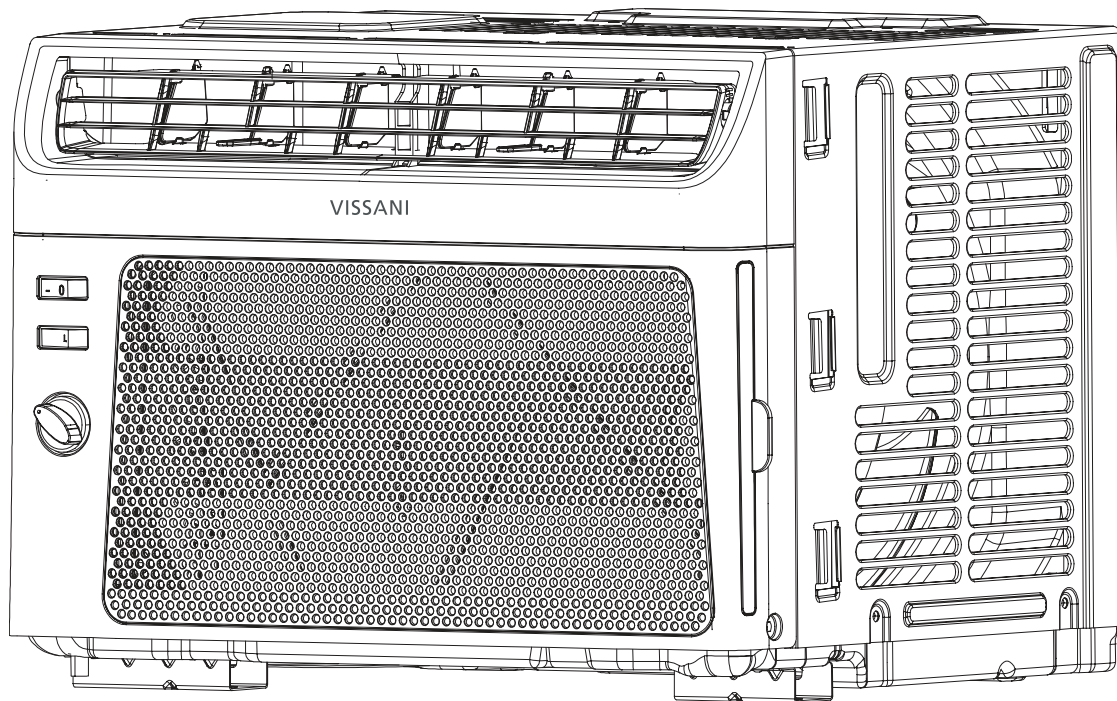

Questions, problems, missing parts? Before returning to the store,
call Vissani Customer Service
8 a.m. - 7 p.m., EST, Monday - Friday, 9 a.m. - 6 p.m., EST, Saturday

1-877-527-0313

HOMEDEPOT.COM

THANK YOU

We appreciate the trust and confidence you have placed in Vissani through the purchase of this air conditioner. We strive to continually create quality products designed to enhance your home. Visit us online to see our full line of products available for your home improvement needs.

Thank you for choosing Vissani!

Table of Contents

Table of Contents 2
Safety Information 3
 Important Safety Instructions 3
 Disposing of the Unit 3
 Installation Requirements 4
 Recommended Grounding Method 4
 Wiring requirement 4
 Power Supply Cord 4
Pre-Installation 4
 Planning Installation 5
 Hardware Included. 6
 Unpack the Air Conditioner 7
 Location Requirements 7
 Window Installation 9
 If AC is Blocked by Storm Window. 9

Installation 10
Operation..... 13
Care and Cleaning 15
 Cleaning the Air Filter 15
 Cleaning the Front Panel 15
 Repairing Paint Damage 15
 Annual Maintenance 15
Troubleshooting 16

Safety Information

We have provided many important safety messages in this manual and on your appliance. Always read and obey all safety messages.



DANGER: This symbol alerts you to a potential hazard, that if not avoided, will result in death or serious injury.



WARNING: This symbol alerts you to a potential hazard, that if not avoided, could result in death or serious injury.



CAUTION: This symbol alerts you to a potential hazard, that if not avoided, may result in minor or moderate injury.

IMPORTANT SAFETY INSTRUCTIONS

To reduce the risk of fire, electrical shock or injury when using your air conditioner, follow these basic precautions:

- Plug into a grounded 3-prong outlet.
- Do not remove ground prong.
- Do not use an adapter.
- Do not use an extension cord.
- Unplug air conditioner before servicing.
- Use two or more people to move and install air conditioner.

DISPOSING OF THE UNIT

- Before throwing out the device, it is necessary to remove the battery cells and dispose or recycle them properly.
- When you need disposal of the unit consult our dealer. If pipes are removed incorrectly, refrigerant may blow out and come into contact with your skin, causing injury. Releasing refrigerant into the atmosphere also damages the environments.
- Please recycle or dispose of the product packaging material in an environmentally responsible manner.
- Never store or ship the air conditioner upside down or sideways to avoid damage to the compressor.
- This appliance is not intended for use by persons (including children) with reduced physical, sensory or mental capabilities, or lack of experience and knowledge, unless they have been given supervision or instruction concerning use of the appliance by a person responsible for their safety. Children should be supervised to ensure that they do not play with the appliance.
- The wiring diagram is shown on nameplate on the air conditioner.

WARNING: Risk of Fire or Explosion. This unit contains flammable refrigerant.

Additional safety precautions must be followed.



- Do not use means to accelerate the defrosting process or to clean, other than those recommended by the manufacturer.
- The appliance shall be stored in a room without continuously operating ignition sources (for example: open flames, an operating gas appliance or an operating electric heater).
- Do not pierce or burn refrigerant tubing. Be aware that refrigerants may not contain an odor.
- Keep ventilation openings clear of obstruction.
- The maximum refrigerant charge amount is shown on nameplate on the air conditioner.
- When handling, installing, and operating the appliance, care should be taken to avoid damage to the refrigerant tubing.
- Do not drill holes in the unit.
- Maintenance, cleaning, and service should only be performed by technicians properly trained and qualified in the use of flammable refrigerants.
- Dispose of air conditioner in accordance with Federal and Local Regulations. Flammable refrigerants require special disposal procedures. Contact your local authorities for the environmentally safe disposal of your air conditioner.
- The appliance shall be stored so as to prevent mechanical damage from occurring.

Pre-Installation

INSTALLATION REQUIREMENTS

WARNING: Electrical Shock Hazard



- Plug into a grounded 3-prong outlet.
- Do not remove ground prong.
- Do not use an adapter.
- Do not use an extension cord.
- Failure to follow these instructions can result in death, fire, or electrical shock.

RECOMMENDED GROUNDING METHOD

This air conditioner must be grounded. This air conditioner is equipped with a power supply cord with a three-prong grounding plug. The cord must be plugged into a three-prong outlet, grounded in accordance with all local codes and ordinances. If a grounded outlet is not available, it is the customer's responsibility to have a properly grounded three-prong outlet installed by a qualified electrical installer.

It is the customer's responsibility:

- To contact a qualified electrical installer.
- To assure that the electrical installation is adequate and conforms to the Nation Electrical Code, ANSI/NFPA 70-last edition, and all local codes and ordinances.

Copies of the standards listed may be obtained from:

National Fire Protection Association

1 Batterymarch Park

Quincy, Ma 02169-7471

www.nfpa.org

WIRING REQUIREMENT

115 V (103.5 V min. to 126.5 V max.)

10 A time-delay fuse or circuit breaker

POWER SUPPLY CORD

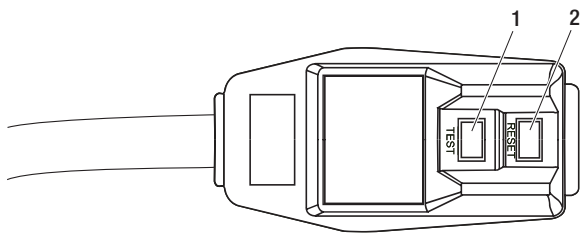

NOTE: Your air conditioner's device may differ from the one shown. This room air conditioner is equipped with a power supply cord required by UL. This power supply cord contains state-of-the-art electronics that sense leakage current. If the cord is crushed, the electronics detect leakage current and power will be disconnected in a fraction of a second.

Pre-Installation

To test your power supply cord:

1. Plug power supply cord into a grounded 3-prong outlet.
2. Press RESET (2) (on some devices, a green light will turn on).
3. Press TEST (1) and listen for click. The RESET button will trip and on some devices, a green light will turn off.
4. Press and release RESET (2) and listen for click. The RESET button will latch, and on some devices, a green light will turn on. The power supply cord is ready for operation.

NOTE: The RESET button must be pushed in for proper operation.



- The power supply cord must be replaced if it fails to trip when the test button is pressed or fails to reset.
- Do not use the power supply cord as an off/on switch. The power supply cord is designed as a protective device.
- A damaged power supply cord must be replaced with a new power supply cord obtained from the product manufacturer and must not be repaired.
- The power supply cord contains no user serviceable parts. Opening the tamper-resistant case voids all warranty and performance claims.

PLANNING INSTALLATION

Gather the required tools and parts before starting installation. Read and follow the instructions provided with any tools listed here

TOOLS REQUIRED



Phillips
screwdriver

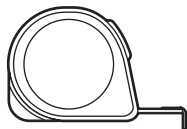

Tape
measure

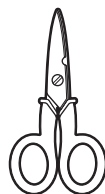

Scissors

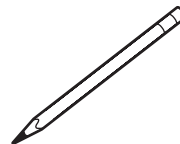

Pencil

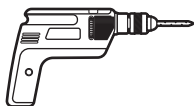

Cordless drill



1/8 in. bit



Level

Pre-Installation

HARDWARE INCLUDED



NOTE: Check that all parts are included in parts package.

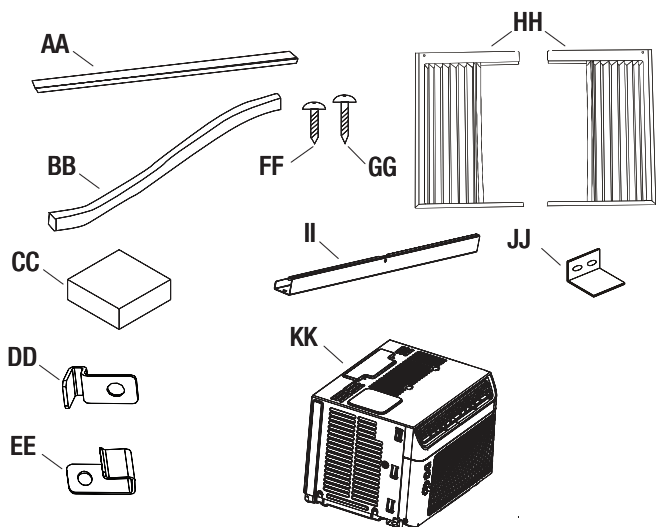

Part	Description	Quantity
AA	Adhesive seal	2
BB	Foam seal	1
CC	Sealing sponge	1
DD	Lock frame (for wooden windows)	2
EE	Lock frame (for vinyl-Clad windows)	2
FF	3/8 inch screws	4
GG	3/4 inch screws	7
HH	Side curtains	2
II	Top rail	1
JJ	Sash lock	1
KK	Air conditioner	1

Pre-Installation (continued)

UNPACK THE AIR CONDITIONER

WARNING: Excessive Weight Hazard



Use two or more people to move and install air conditioner.

Failure to do so can result in back or other injury.

Remove packaging materials

- Remove and dispose of/recycle packaging materials. Remove tape and glue residue from surfaces before turning on the air conditioner. Rub a small amount of liquid dish soap over the adhesive with your fingers. Wipe with warm water and dry.
- Do not use sharp instruments, rubbing alcohol, flammable fluids, or abrasive cleaners to remove tape or glue. These products can damage the surface of your air conditioner.
- Handle the air conditioner gently.
- Remove top rail (II) from the packaging material.

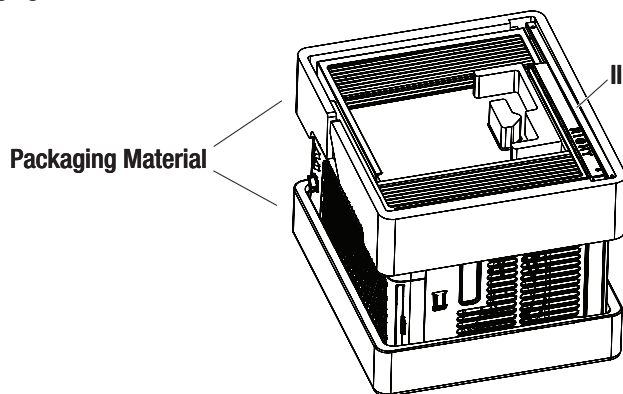

LOCATION REQUIREMENTS

Before you Begin

Read these instructions completely and carefully.

IMPORTANT:



- Save these instructions for local inspector's use.
- Observe all governing codes and ordinances.



NOTE: Installer, be sure to leave these instructions with the Consumer.



NOTE: Consumer, keep these instructions for future reference.

- Skill level:** Installation of this appliance requires basic mechanical skills.
- Completion time:** Approximately 1 hour.
- We recommend that two people install this product.

Pre-Installation (continued)

- Proper installation is the responsibility of the installer.
- Product failure due to improper installation is not covered under the warranty.
- You **MUST** use all supplied parts and use proper installation procedures as described in these instructions when installing this air conditioner.



IMPORTANT: Observe all governing codes and ordinances.

Check the location where air conditioner will be installed. Proper installation is your responsibility. Make sure you have everything necessary for correct installation.

The location should provide:

- Do not use an extension cord. The appliance shall be installed in accordance with national wiring regulations.
- Free movement of air in room to be cooled.
- A large enough opening for the air conditioner.



NOTE: Cabinet louvers (A) must not be obstructed. Air must be able to pass freely through the cabinet louvers.

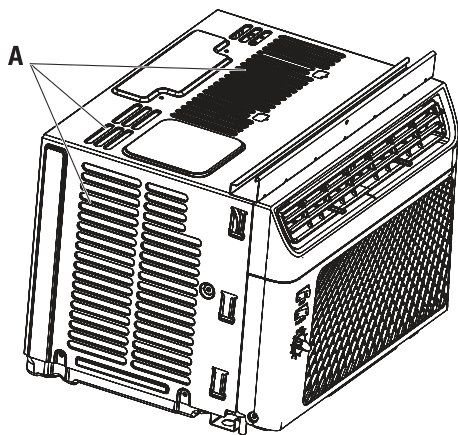

Pre-Installation (continued)

WINDOW OPENING MEASUREMENTS

- These instructions are for a standard double-hung window. You will need to modify them for other types of windows.
- The air conditioner can be installed without the side curtain panels if needed to fit in a narrow window. See the window opening dimensions.
- All supporting parts must be secured to firm wood, masonry or metal.
- The electrical outlet must be within reach of the power cord.
- Follow the dimensions in the table and illustration for your model.

Models	A	B
5KBTU	12 2/5 inch (315 mm) min	22 inch (559 mm) - 37 4/5 inch (960 mm)

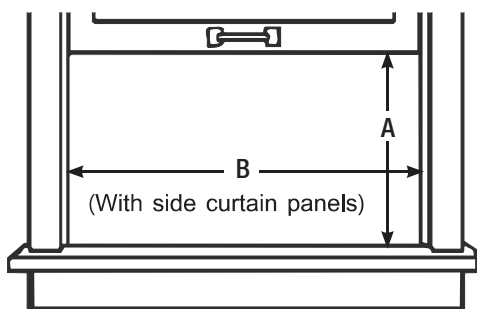

IF AC IS BLOCKED BY STORM WINDOW

Add wood as shown, or remove storm window before air conditioner is installed.

If storm window frame must remain, be sure the drain holes or slots are not caulked or painted shut. Accumulated rain water or condensation must be allowed to drain out.

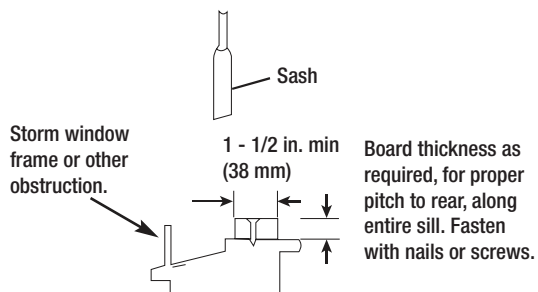

Installation

1 Attaching the Top Rail

- Locate the bag of screws provided.
- Place the top rail (B) on top of the air conditioner cabinet, lining up the 4 holes in the top rail (B) with the 4 holes on top of the air conditioner cabinet.
- Using four 3/8 inch (10 mm) screws (A), attach the top rail (B) to the air conditioner cabinet.

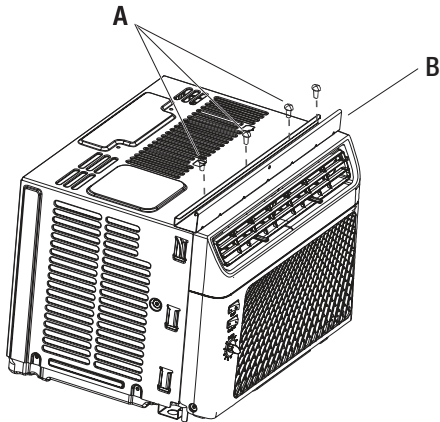

2 Installing the Side Curtains



NOTE: Attach curtains to the air conditioner before placing the air conditioner in window.

- Slide the side curtain (HH) directly into the cabinet (B).
- Slide the side curtain (HH) down.

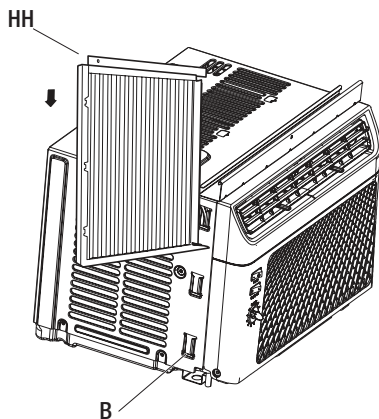

NOTE: Attach side curtains to the air conditioner before placing the air conditioner in window.

- Insert top and then bottom of right-hand curtain housing (A) in top and bottom curtain rails (B) on air conditioner.

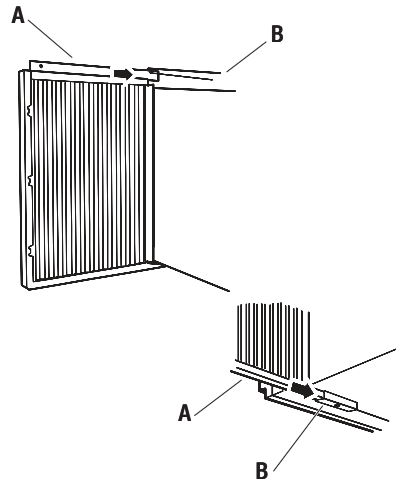

- Slide the curtain housing into the channels as far as it will go.
- Repeat above steps for the left-hand curtain.

3 Attaching the Adhesive Seal

- Cut the adhesive seal to the width of the lower window sash.
- Remove the backing from the seal and attach the seal to the bottom of the lower window sash.

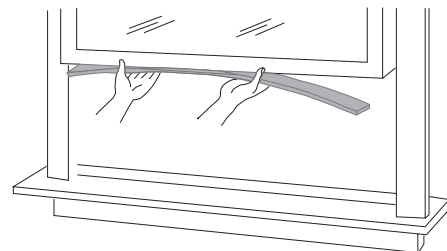

Installation (continued)

4 Placing Air Conditioner in Window



WARNING: Excessive Weight Hazard

- Use two or more people to move and install air conditioner.
- Failure to do so can result in back or other injury.



NOTES:

- Handle air conditioner gently.
- Be sure your air conditioner does not fall out of the opening during installation or removal.
- Do not block the louvers in the front panel.
- Do not block the louvers on the outside of the air conditioner.

- Center air conditioner in window. Lower the window sash (A) behind the top rail to hold cabinet in place.
- Keep a firm grip on the air conditioner, carefully place the unit into the window opening so the bottom of the air conditioner frame is against the window sill and make sure the unit is staying center of the window.
- Carefully close the window behind the top rail of the unit.

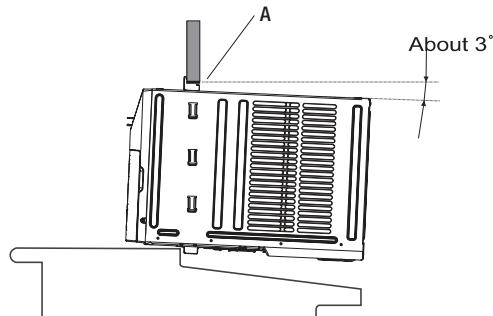

- Place the frame lock between the frame extensions and the window sill with 3/4 inch (19 mm) screw as shown.

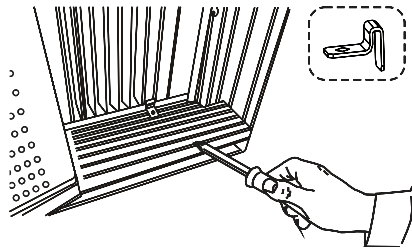

- To secure lower sash in place, attach right angle sash lock with 3/4 inch (19 mm) screw as shown.

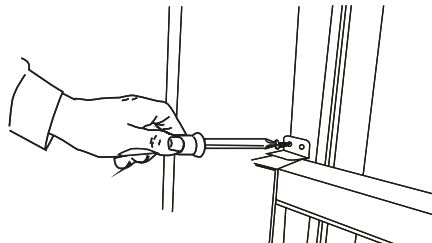

Installation (continued)

5 Attaching Side Curtains to Window

- Pull the left-hand curtain out until it fits into the window channel.
- Use a 1/8 inch (3 mm) drill bit to drill a starter hole through the hole in the top rail.
- Insert one of the 3/4 inch (19 mm) screws (C) through the left-hand curtain (B) and into the window sash (A).

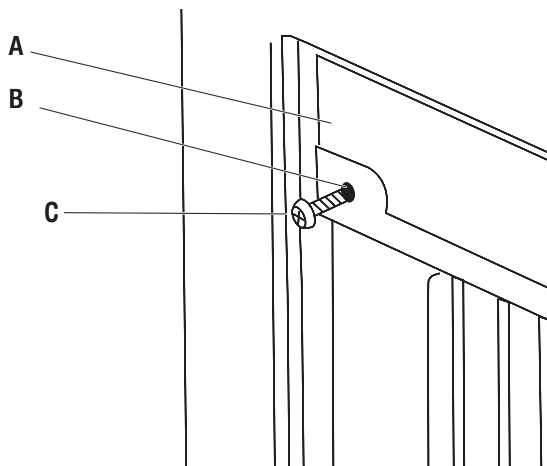

6 Completing Installation

- Insert foam seal (B) behind the top of the lower window sash (A) and against the glass of the upper window.

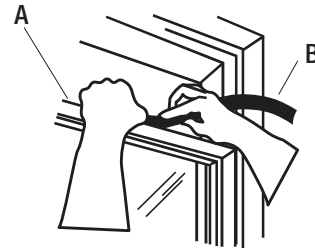

- Use a 1/8 inch (3 mm) drill bit to drill a starter hole through the hole in the top rail.
- Attach top channel to window sash with one 3/4 inch (19 mm) screw to secure window in place.

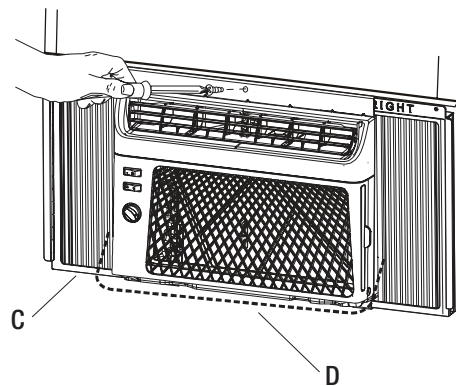

- Check the gap (D) around the unit (C) and seal it with the adhesive seal attached.

DANGER: ELECTRICAL SHOCK HAZARD



- Plug into a grounded 3-prong outlet.
- Do not remove ground prong.
- Do not use an adapter.
- Do not use an extension cord.
- Failure to follow these instructions can result in death, fire, or electrical shock.

- Plug into a grounded 3-prong outlet.
- Press RESET on the power supply cord. See "Electrical Requirements".

Operation

AIR CONDITIONER USE

IMPORTANT:



- If you turn off the air conditioner, wait at least 3 minutes before turning it back on. This prevents the air conditioner from blowing a fuse or tripping a circuit breaker.
- Air conditioner in the Cool mode operation the better limits: Outdoor 64.4-109.4°F (18-43 °C), 80% RH; indoor 62.6-89.6°F (17-32°C), 80% RH.

- Operating your air conditioner properly helps you to obtain the best possible results.
- This section explains proper air conditioner operation.

1 Power

- Press the power button to turn on the air conditioner.



NOTE: Wait 3 minutes before restarting the appliance to prevent damaging the compressor.

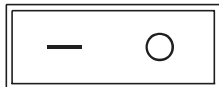

2 Fan Speed

- Use the Fan Speed button to select your choice of fan speeds for air circulation.
- Choose High or Low.
 - High - for maximum cooling
 - Low - for quieter cooling



3 Fan Only

- Fan Only mode. Press Fan Speed to select High or Low.



NOTE: In Fan Only mode, the compressor will not run.

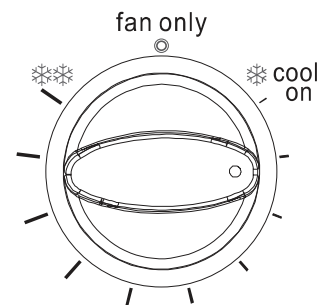

Operation (continued)

4 Thermostat

- The thermostat is used to set the desired room temperature when the unit is being operated in the COOL MODE.
- To set the desired room temperature, rotate the thermostat switch to the desired setting. After the set temperature is achieved the thermostat will automatically start and stop the compressor in order to maintain the desired set temperature.
- Rotate the thermostat selector clockwise for higher cool settings.
- Higher cool settings will provide lower room temperature. Rotate the thermostat selector counterclockwise for lower cool settings. Lower cool settings will provide higher room temperature.



NOTE: The controls featured in this manual are representative of many available models. Your model may offer slightly different features.

5 Changing Air Direction

- Use the Vertical Level Vane (A) to direct the air right or left. Use the whole cartridge (B) to direct air up, down or straight ahead.

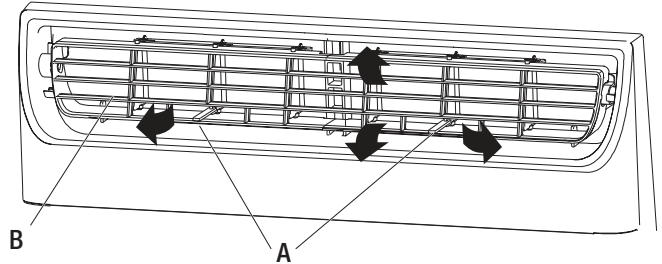

6 Normal Sounds

When your air conditioner is operating normally, you may hear sounds such as:

- Droplets of water hitting the condenser, causing a pinging or clicking sound. The water droplets help cool the condenser.
- Air movement from the fan.
- Clicks from the thermostat cycle.
- Vibrations or noise due to poor wall or window construction.
- A high-pitched hum or pulsating noise caused by the modern high-efficiency compressor cycling on and off.

Care and Cleaning

Your new air conditioner is designed to give you many years of dependable service. This section tells you how to clean and care for your air conditioner properly. Call your local authorized dealer for an annual checkup. Remember the cost of this service call is your responsibility.

CLEANING THE AIR FILTER

The air filter is removable for easy cleaning. A clean filter helps remove dust, lint, and other particles from the air and is important for best cooling and operating efficiency. Check the filter every 2 weeks to see whether it needs cleaning.



NOTE: Do not operate the air conditioner without the filter in place.

- Turn off the air conditioner.
- Remove the air filter (A) by sliding the filter out from the right-hand side of the front panel.

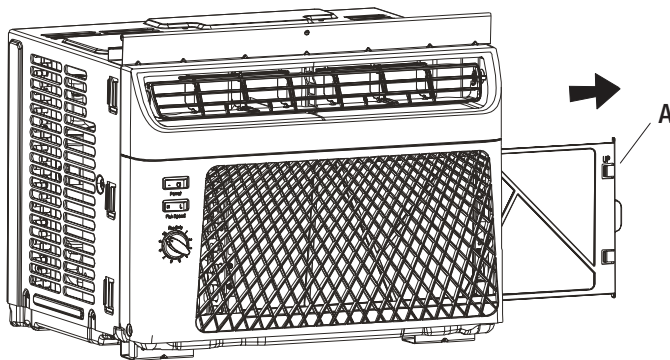

- Use a vacuum cleaner to clean the air filter (A). If the air filter is very dirty, wash it in warm water with a mild detergent. Do not wash the air filter in the dishwasher or use any chemical cleaners. Air dry the filter completely before replacing to ensure maximum efficiency.
- Replace the air filter back into the air conditioner.

CLEANING THE FRONT PANEL

- Turn off the air conditioner.
- Clean the front panel with a soft, damp cloth.
- Air dry the front panel completely.



REPAIRING PAINT DAMAGE

Check once or twice a year for paint damage. This is very important, especially in areas near oceans or where rust is a problem. If needed, touch up with a good grade enamel paint.

ANNUAL MAINTENANCE

Your air conditioner needs annual maintenance to help ensure steady, top performance throughout the year. Call your local authorized dealer to schedule an annual checkup. The expense of an annual inspection is your responsibility.

Troubleshooting

Problem	Solution
Air conditioner will not operate	<div style="border: 1px solid black; padding: 5px; margin-bottom: 10px;"> <p style="text-align: center;">DANGER: ELECTRICAL SHOCK HAZARD</p> <div style="display: flex; align-items: center;">  <ul style="list-style-type: none"> <input type="checkbox"/> Plug into a grounded 3-prong outlet. <input type="checkbox"/> Do not remove ground prong. <input type="checkbox"/> Do not use an adapter. <input type="checkbox"/> Do not use an extension cord. <input type="checkbox"/> Failure to follow these instructions can result in death, fire, or electrical shock. </div> </div> <ul style="list-style-type: none"> <input type="checkbox"/> The power supply cord is unplugged. Plug into grounded 3-prong outlet. See “Electrical Requirements”. <input type="checkbox"/> The power supply cord has tripped (RESET button has popped out). Press and release RESET to resume operation. <input type="checkbox"/> A household fuse has blown, or circuit breaker has tripped. Replace the fuse or reset the circuit breaker. If the problem continues, call an electrician. See “Electrical Requirements”. <input type="checkbox"/> The Power button has not been pressed. Press the Power button. <input type="checkbox"/> The local power has failed. Wait for power to be restored.
Air conditioner blows fuses or trips circuit breakers	<ul style="list-style-type: none"> <input type="checkbox"/> Too many appliances are being used on the same circuit. Unplug or relocate appliances that share the same circuit. <input type="checkbox"/> Time-delay fuse or circuit breaker of the wrong capacity is being used. Replace with a time-delay fuse or circuit breaker of the correct capacity. See “Electrical Requirements”. <input type="checkbox"/> An extension cord is being used. Do not use an extension cord with this or any other appliance. <input type="checkbox"/> You are trying to restart the air conditioner too soon after turning off the air conditioner. Wait at least 3 minutes after turning off the air conditioner before trying to restart the air conditioner.
Air conditioner power supply cord trips (Reset button pops out)	<ul style="list-style-type: none"> <input type="checkbox"/> Disturbances in your electrical current can trip (RESET button will pop out) the power supply cord. Press and release RESET to resume operation. <input type="checkbox"/> Electrical overloading, overheating, cord pinching or aging can trip (RESET button will pop out) the power supply cord. After correcting the problem, press and release RESET to resume operation. <div style="border: 1px solid black; padding: 5px; margin-top: 10px;"> <div style="display: flex; align-items: center;">  <p>NOTE: A damaged power supply cord must be replaced with a new power supply cord obtained from the product manufacturer and must not be repaired.</p> </div> </div>

Troubleshooting (continued)

Problem	Solution
Air conditioner seems to run too much	<ul style="list-style-type: none"> □ The current air conditioner replaced an older model. The use of more efficient components may cause the air conditioner to run longer than an older model, but the total energy consumption will be less. Newer air conditioners do not emit the “blast” of cold air you may be accustomed to from older air conditioners, but this is not an indication of lesser cooling capacity or efficiency. Refer to the efficiency rating (EER) and capacity rating (in Btu/h) marked on the air conditioner. □ The air conditioner is in a heavily occupied room, or heat producing appliances are in use in the room. Use exhaust vent fans while cooking or bathing and try not to use heat producing appliances during the hottest part of the day. A higher capacity air conditioner may be required, depending on the size of the room being cooled.
Air conditioner cycles on and off too much or does not cool	<ul style="list-style-type: none"> □ The air conditioner is not properly sized for your room. Check the cooling capabilities of your room air conditioner. Room air conditioners are not designed to cool multiple rooms. □ The filter is dirty or obstructed by debris. Clean the filter. □ The inside evaporator and outside condenser coils are dirty or obstructed by debris. See Annual Maintenance. □ There is excessive heat or moisture (open container cooking, showers, etc.) in the room. Use a fan to exhaust heat or moisture from the room. Try not to use heat producing appliances during the hottest part of the day. □ The louvers are blocked. Install the air conditioner in a location where the louvers are free from curtains, blinds, furniture, etc. □ The temperature of the room you are trying to cool is extremely hot. Allow extra time for the air conditioner to cool off a very hot room. □ Windows or doors to the outside are open. Close all windows and doors. □ The Temp control is not at a cool enough setting. Adjust the Temp control to a cooler setting by pressing the minus button to reduce the temperature. Set the Fan Speed control to the highest setting.
Water drips from cabinet into your house	<ul style="list-style-type: none"> □ The air conditioner is not properly leveled. The air conditioner should slope slightly downward toward the outside. Level the air conditioner to provide a downward slope toward the outside to ensure proper drainage. See the Installation Instructions. <div style="border: 1px solid black; padding: 5px; margin-top: 10px;">  <p>NOTE: Do not drill a hole in the bottom of the metal base and condensate pan.</p> </div>

VISSANI™

Questions, problems, missing parts? Before returning to the store,
call Vissani Customer Service
8 a.m. - 7 p.m., EST, Monday - Friday, 9 a.m. - 6 p.m., EST, Saturday

1-877-527-0313

HOMEDEPOT.COM

Retain this manual for future use.