

Haier

User Manual
Guide de l'utilisateur
Manual del usuario
HCW225LAES
HCW225RAES

24" Built-in Oven

Four à convection simple de 24"

Horno de convección simple de 24"

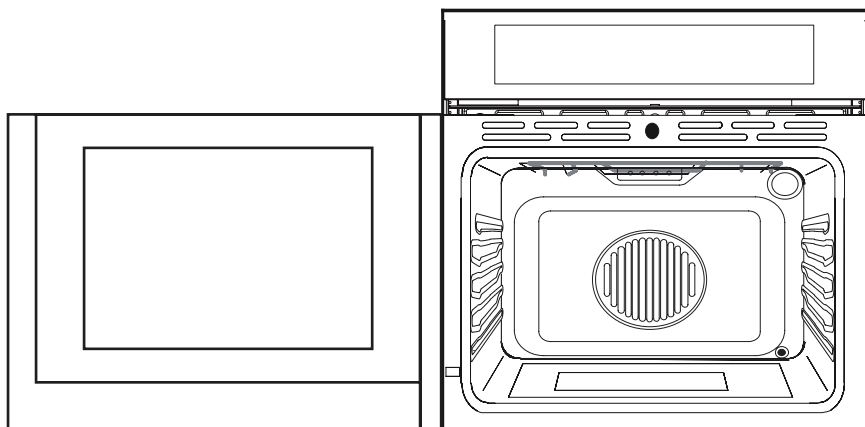

TABLE OF CONTENTS

OVEN SAFETY INSTRUCTIONS	2
FEATURES OF YOUR OVEN	6
GENERAL OVEN INFORMATION	7
GENERAL OVEN TIPS	8
ELECTRONIC CONTROL	10
COOKING WITH THE CONVECTION OVEN	15
OVEN MODES	16
QUICK TIPS	19
CONVECTION BAKE TIPS AND TECHNIQUES	20
BAKE TIPS AND TECHNIQUES	22
CONVECTION BROIL TIPS AND TECHNIQUES	23
BROIL TIPS AND TECHNIQUES	24
CONVECTION ROAST TECHNIQUES	26
GENERAL OVEN CARE	29
OVEN FINISHES / CLEANING METHODS	30
OVEN DOOR REMOVAL	31
REPLACING AN OVEN LIGHT	32
TROUBLESHOOTING	33
LIMITED WARRANTY	35

RECORD KEEPING

Thank you for purchasing this Haier product. This user manual will help you get the best performance from your new oven.

For future reference, record the model and serial number located on the inside frame of the oven, and the date of purchase.

Staple your proof of purchase to this manual to aid in obtaining warranty service if needed.

Model number

Serial number

Date of purchase

OVEN SAFETY INSTRUCTIONS

Your safety and the safety of others are very important.

We have provided many important safety messages in this manual and on your appliance. Always read and obey all safety messages.



This is the safety alert symbol.

This symbol alerts you to potential hazards that can kill or hurt you and others. All safety messages will follow the safety alert symbol and either the word "DANGER," "WARNING" or "CAUTION."

These words mean:



An imminently hazardous situation. You could be killed or seriously injured if you don't immediately follow instructions.



A potentially hazardous situation which, if not avoided, could result in death or serious bodily injury.



A potentially hazardous situation which, if not avoided, may result in moderate or minor injury.

All safety messages will tell you what the potential hazard is, tell you how to reduce the chance of injury, and tell you what can happen if the instructions are not followed.

⚠ WARNING

The California Safe Drinking Water and Toxic Enforcement Act requires the Governor of California to publish a list of substances known to the State of California to cause cancer, birth defects, or other reproductive harm, and requires businesses to warn of potential exposure to such substances.

This product contains a chemical known to the State of California to cause cancer, birth defects, or other reproductive harm. This appliance can cause low-level exposure to some of the substances listed, including benzene, formaldehyde, carbon monoxide, toluene, and soot.

WARNINGS FOR ELECTRIC INSTALLATION

WARNING



Electrical Shock Hazard

Installation and service must be performed by a qualified installer or service agency.

The models may be powered at 240V or 208V.

Always disconnect the power before servicing this unit.

This appliance must be properly grounded.

Failure to do so could result in death or serious injury.

IMPORTANT SAFETY INSTRUCTIONS

WARNING: To reduce the risk of fire, electrical shock, injury to persons, or damage when using the cooktop, follow basic precautions, including the following:

Proper Installation

- This appliance must be properly installed and electrically grounded by a qualified technician. Connect only to properly grounded outlet. See "Grounding Instructions" found in the Installation Instructions.
- This appliance should be serviced only by a qualified service technician. Contact the nearest authorized service center for examination, repair or adjustment.
- Do not repair or replace any part of the oven unless specifically recommended. Refer service to an authorized servicer.
- Do not operate this appliance if it is not working properly or if it has been damaged, until an authorized servicer has examined it.
- Install or locate this appliance only in accordance with the Installation Instructions.
- Use this oven only as intended by the manufacturer. If you have any questions, contact the manufacturer.

IMPORTANT SAFETY INSTRUCTIONS

- Do not cover or block any openings on this appliance.
- Use this appliance only for its intended use as described in this manual. Do not use corrosive chemicals, vapors, or nonfood products in this appliance. This type of oven is specifically designed to heat or cook. It is not designed for industrial or laboratory use. The use of corrosive chemicals in heating or cleaning will damage the appliance.
- Be sure the blower fan runs whenever the oven is in operation. If the fan does not operate, do not use the oven. Call an authorized service center.
- Never use the oven to warm or heat a room.

To reduce the risk of fire in the oven cavity:

- Do not store flammable materials in or near the oven.
- Do not use water on a grease fire. Smother fire or use a dry chemical or foam-type extinguisher.
- It is highly recommended that a fire extinguisher be readily available and highly visible next to any cooking appliance.
- Do not overcook food. Carefully attend oven if paper, plastic or other combustible materials are placed inside the oven.
- Do not use the cavity for storage purposes. Do not leave paper products, cooking utensils or food in the cavity when not being used.
- If materials inside the oven should ignite, keep oven door closed. Turn oven off and disconnect the circuit at the circuit breaker box.

Personal Safety

- Do not allow children to use this appliance unless closely supervised by an adult. Children and pets should not be left alone or unattended in the area where the appliance is in use. Never allow children to sit or stand on any part of the oven.
- Do not store items of interest to children above the oven. If children should climb onto the appliance to reach these items, they could be seriously injured.
- For personal safety, wear proper clothing. Loose fitting or garments with hanging sleeves should never be worn while using this appliance.
- Tie long hair so that it doesn't hang loose.
- Do not touch heating elements or interior surfaces of oven.
- The heating elements may be hot even though they are dark in color. Interior surfaces of an oven become hot enough to cause burns.

IMPORTANT SAFETY INSTRUCTIONS

- During and after use, do not touch or let clothing or other flammable materials contact the heating elements or the interior surfaces of the oven until they have had sufficient time to cool.
- The trim on the top and sides of the oven door may become hot enough to cause burns.
- Use care when opening the door. Open the door slightly to let hot air or steam escape before removing or replacing food.
- Do not heat unopened food containers. Build-up of pressure may cause the container to burst and cause injury.
- Always place oven racks in desired location while oven is cool. If a rack must be moved while oven is hot, do not let pot holder contact the hot heating elements.
- Use only dry pot holders. Moist or damp pot holders on hot surfaces may result in burns from steam. Do not let pot holder touch hot heating elements. Do not use a towel or other bulky cloth.

Safety for the Self-cleaning Oven:

- Before self-cleaning the oven, remove the broiler pan, oven racks (only when not made of porcelain), other utensils and excess soft spillage.
- Confirm that the door locks and will not open once both selectors are in CLEAN position and the door lock icon appears. If the door does not lock, turn the cook mode selector to OFF and do not run Self-Clean. Call an authorized servicer.
- Do not clean the door gasket. It is essential for a good seal. Care should be taken not to rub, damage, move or remove the door gasket.
- Do not use commercial oven cleaners or oven liner protective coatings of any kind in or around any part of the oven.
- Clean only oven parts listed in this manual.
- Other surfaces of the appliance may become hot enough to cause burns - among these surfaces are for example: oven vent openings and surfaces near these openings, oven doors, and windows of oven doors.

READ AND SAVE THESE INSTRUCTIONS

FEATURES OF YOUR OVEN

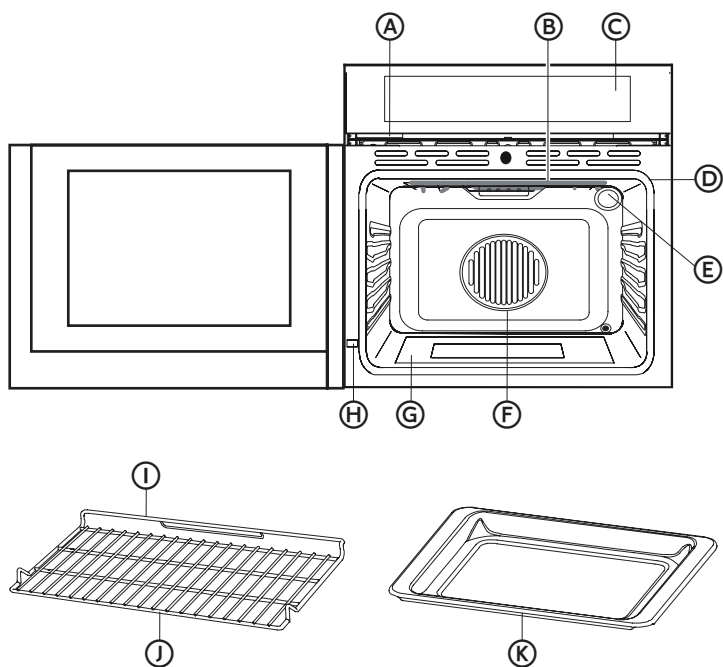

(A) Cooling Vents

(B) Broil Element

(C) Control Panel

(D) Door Gasket

(E) Oven Light

(F) Convection Fan and Element

(G) Bottom Element (not visible)

(H) Model and Serial # Plate

(I) Oven Rack Back

(J) Oven Rack Front

(K) Drip Pan

GENERAL OVEN INFORMATION

! WARNING



Fire Hazard

Remove all packing and foreign materials from the oven. Any material of this sort left inside may melt or burn when the appliance is used.

Failure to do so can result in death or fire.

240 V VS. 208 V CONNECTION

Most oven installations will have a 240 V connection. If your oven is installed with 208 V, the preheat time may be slightly longer than with 240 V. The oven is designed to assure the same clean time at 208 V.

HEATING FIRST TIME

Heat the empty appliance to the maximum temperature in order to remove any manufacturing residues, which could affect the food with unpleasant odors.

DRIP PAN

Place the drip pan (provided) on the bottom shelf of the oven to prevent any sauce and/or grease from dripping onto the bottom of the oven only when broiling food. For all other types of cooking, never use the bottom shelf and never place anything on the bottom of the oven when it is in operation because this could damage the enamel. Always place your cookware (dishes, aluminum foil, etc.) on the oven rack.

HIGH ALTITUDE BAKING

When cooking at high altitude, recipes and cooking time will vary from the standard.

POWER FAILURE

When the appliance is connected to the electrical supply or when there has been a power cut, the symbol for Time ⌚ flashes automatically.

ERROR

In the event of an error the display flashes and beeps continuously. Disconnect appliance from the power supply and call a qualified technician.

BEEPS

Signal that the set temperature has been reached. Beeps also signal the end of a function or an oven fault.

GENERAL OVEN TIPS

DEFAULT SETTINGS

The Cooking Modes automatically select a suitable temperature. These can be changed when a different one is needed.

OVEN CONDENSATION AND TEMPERATURE

- It is normal for a certain amount of moisture to evaporate from the food during any cooking process. The amount depends on the moisture content of the food. The moisture may condense on any surface cooler than the inside of the oven, such as the control panel.
- Your new oven has an electronic temperature sensor that allows maintaining an accurate temperature. Your previous oven may have had a mechanical thermostat that drifted gradually over time to a higher temperature. It is normal that you may need to adjust your favorite recipes when cooking in a new oven.

OPERATIONAL SUGGESTIONS

- Use the Cooking Charts as a guide.
- Do not set any weight on the open oven door.
- Use the interior oven lights to view the food through the oven door window rather than opening the door frequently.

UTENSILS

- Glass baking dishes absorb heat. Reduce oven temperature 25 °F (15 °C) when baking in glass.
- Use pans that give the desired browning. The type of finish on the pan will help determine the amount of browning that will occur.
- Shiny, smooth metal or light non-stick /anodized pans reflect heat, resulting lighter more delicate browning. Cakes and cookies require this type of utensil.
- Dark, rough or dull pans will absorb heat resulting in a browner, crisper crust. Use this type for pies.
- For brown, crisp crusts, use dark non-stick/anodized or dark, dull metal utensils or glass bake ware. Insulated baking pans may increase the length of cooking time.
- Place the dripping pan provided on the bottom shelf of the oven to prevent any sauce and/or grease from dripping onto the bottom of the oven only when grilling food.

OVEN RACKS

- The oven has rack guides at four levels as shown in the illustration.
- Rack positions are numbered from the bottom rack guide (#1) to the top (#4).
- Check Cooking Charts for best rack positions to use when cooking.
- Each level guide consists of paired supports formed in the walls on each side of the oven cavity.
- Always be sure to position the oven racks before turning on the oven. Make sure that the racks are level once they are in position.

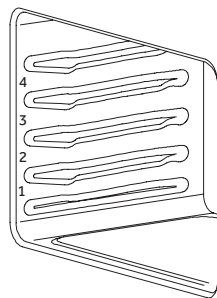

Please refer to illustration on "Features of Your Oven" if there is any question as to which side is the front or top of the rack.

- The racks are designed to stop when pulled forward to their limit.

IMPORTANT: Never use aluminum foil to cover the oven racks or to line the oven. It can cause damage to the oven liner if heat is trapped under the foil.

IMPORTANT: Make sure you do not force it to avoid damage to the enamel.

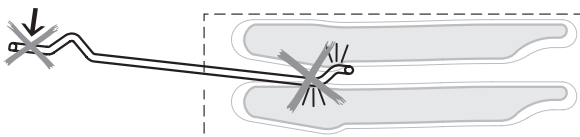

To remove oven rack from the oven:

1. Pull rack forward.

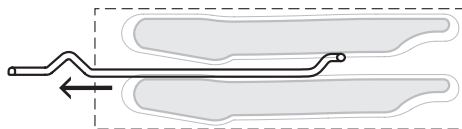

2. Lift rack up at front and then remove it.

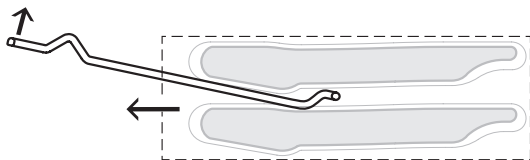

To replace an oven rack:

1. Place rear of rack between rack level guides

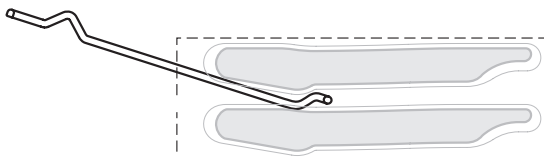

- While lifting front of rack, slide rack in all the way while lowering the front.

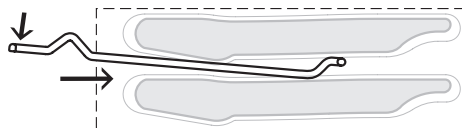

ELECTRONIC CONTROL

CONTROL PANEL DESCRIPTION

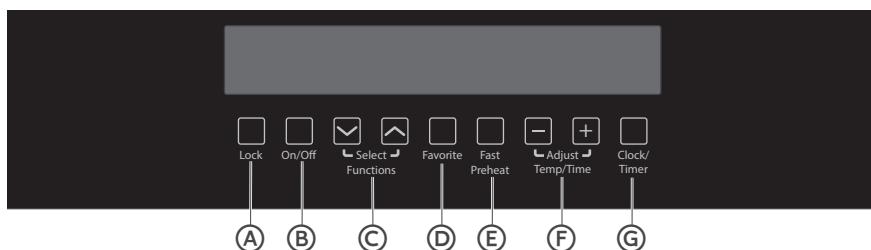

- | | |
|------------------------------------|------------------------------|
| (A) Lock Button | (E) Fast Preheat Button |
| (B) On/Off Button | (F) Temp/Time Adjust Buttons |
| (C) Oven Function Selector Buttons | (G) Clock/Timer Button |
| (D) Favorite Button | |

- Always turn the appliance on first by pressing the On/Off button.
- When the selected function is lit, the oven begins to heat up or the time set begins to count down.
- When the selected temperature is reached, a signal sounds.
- The oven light is turned on as long as an oven function is started.
- The oven light automatically turns off 10 minutes after the end of a cooking cycle.
- Turn off oven using the On/Off button.

SETTING THE TIME OF DAY

The oven operates only when the time has been set.



- To change a time that has already been set, press CLOCK/TIMER repeatedly until the symbol for Time ☺ flashes.
- Using the or button, set the current time.

After about 5 seconds, the flashing stops and the clock displays the time of day.



The oven is now ready for use.

TOUCHPAD SOUND



Turning OFF touchpad sound

1. Turn off the appliance using the On/Off button.
2. Press and hold the  and  buttons at the same time until a signal sounds (approx. 2 seconds). The touchpad sound is now off.

Turning ON touchpad Sound

1. Press and hold the  and  buttons at the same time until a signal sounds (approx. 2 seconds). The touchpad sound is reactivated.

SELECTING THE OVEN FUNCTION



1. Turn on the oven with the On/Off button.
2. Press the  or  button repeatedly until the desired oven function appears.
 - A suggested temperature appears on the temperature display.
 - If the suggested temperature is not changed within approx. 5 seconds, the oven begins to heat up.

CHANGING THE OVEN TEMPERATURE

Press the  or  button, to raise or lower the temperature.

The setting changes in steps of 5°.

THERMOMETER SYMBOL

- The slowly rising thermometer symbol  indicates how hot the oven is as it heats up.
- The three segments of the thermometer symbol  show that Fast Preheat is working.

FAST PREHEAT

After an oven function is selected, with the use of the additional function Fast Preheat the empty oven can be preheated in a relatively short time.

IMPORTANT: Do not put the food to be cooked into the oven, until Fast Preheat is completed and the oven is operating using the desired function.

1. Set the desired function. If necessary, change the suggested temperature.
2. Press FAST PREHEAT. The symbol  lights up:

The bars flashing one after another show that Fast Preheat is operating.

When the set temperature is reached, the bars of the heat indicator light up. An audible signal sounds. The symbol  goes out.

The oven now continues heating according to the pre-set oven function and temperature. You can now place the food in the oven.

FAVORITE

The Favorite function can be used to save a setting which is used frequently.



1. Set oven function, temperature and if necessary the clock functions Clock time |→| and/or End time →|.
2. Press and hold FAVORITE for approx. 2 seconds, until a signal sounds. The setting is saved.

To save another setting, press FAVORITE for approx. 2 seconds. The previously saved setting is replaced by the new one.

Starting the Favorite function

1. Turn the oven on using the button On/Off.
2. Press FAVORITE to call up the saved setting.





CLOCK FUNCTIONS

- After a clock function has been selected, the corresponding symbol flashes for approx. 5 seconds. During this time, the desired time-of-day can be set or modified using the  or  button.
- When the desired time-of-day has been set, the symbol continues to flash for approx. 5 seconds. After this the symbol lights up. The set Countdown  begins to count down.
- The time set for Cook time |→| and End time →| begins to count down after the selected function starts.

Countdown

To set a countdown. A signal sounds after the time has elapsed.

This function does not affect the operation of the oven.

1. Press the Clock Functions  button repeatedly until the symbol for Countdown  flashes.
2. Set the desired Countdown time using the  or  button (max. 99.00 minutes).

After approx. 5 seconds the display shows the time remaining.

The symbol for Countdown  lights up.





When the time set has elapsed, an audible signal sounds for 2 minutes. "0.00" lights up and the symbol for Countdown  flashes.

To turn off the audible signal:

Press any button.

Cook time |→|

To set how long the oven is to be in use.

1. Select oven function and using  or  button select temperature.
2. Press CLOCK/TIMER repeatedly until the symbol for Clock time |→| flashes.
3. Using the  or  button set the desired cooking time.

The oven turns itself on. The symbol for Cook time |→| lights up.

By repeatedly pressing CLOCK/TIMER, the current time can be called up.

When the time has elapsed, an audible signal sounds for 2 minutes.

The oven turns itself off.

"0.00" is displayed and the symbol for Cook time |→| flashes.

To turn off the audible signal:

Press any button.





End time →|

WARNING

Food Poisoning Hazard

Do not let food sit in oven more than one hour before or after cooking.
Doing so can result in food poisoning or sickness.

To set when the oven is to turn off again.

1. Select oven function and using  or  button select temperature.
2. Press CLOCK/TIMER repeatedly until the symbol for End time →| flashes.
3. Using the  or  button set the desired turn-off time.

The symbols for End time →| and Cook time |→| light up.

The oven will automatically turn itself on.

By repeatedly pressing CLOCK/TIMER, the current time can be called up.

When the time has elapsed, an audible signal sounds for 2 minutes.

The oven turns itself off.

"0.00" is displayed and the symbols for End time →| and Cook time |→| flash.

To turn off the audible signal:

Press any button.

Cook time \rightarrow and End time \rightarrow combined**! WARNING****Food Poisoning Hazard**

Do not let food sit in oven more than one hour before or after cooking.
Doing so can result in food poisoning or sickness.

Cook time \rightarrow and End time \rightarrow can be used simultaneously, if the oven is to be turned on and off automatically at a later time.

1. Select oven function and temperature.
2. Using the Cook time \rightarrow function, set the time that the dish needs to cook, e.g., 1 hour.
3. Using the End time \rightarrow function, set the time at which the dish is to be ready, e.g. 2:05.

The symbols for Cook time \rightarrow and End time \rightarrow light up.

The oven turns on automatically at the time calculated, e.g. 1:05.

When the set cooking time has elapsed, an audible signal sounds for 2 minutes.

The oven turns itself off, e.g. 2:05.

OTHER FUNCTIONS**Turning off the display**

You can save energy by turning off the display.

1. If required, turn off the appliance using the On/Off button.
2. Press CLOCK/TIMER and  at the same time until the display goes out.

As soon as the appliance is turned on again, the display comes on automatically

When the appliance is next turned off, the display goes out again.

Turning on the display

1. If required, turn off the appliance using the On/Off button.
2. Press CLOCK/TIMER and  at the same time until the display comes on again.

LOCK FUNCTION

As soon as the Lock is engaged, the appliance can no longer be turned on.

Activating the Lock

1. If necessary, turn on the appliance using the On/Off button.

No oven function must be selected.

2. Press and hold LOCK until  appears in the display.

The child safety device is now activated.

Deactivating the Lock

1. To activate, turn on the appliance using the On/Off button.
2. Press and hold LOCK until **L** disappears from the display.

Lock is now deactivated and the appliance is again ready for use.

COOKING WITH THE CONVECTION OVEN

In a conventional oven, the heat sources cycle on and off to maintain an average temperature in the oven cavity.

As the temperature gradually rises and falls, gentle air currents are produced within the oven. This natural convection tends to be inefficient because the currents are irregular and slow. In this convection system the heat is “conveyed” by a fan that provides continuous circulation of the hot air. This European Convection system provides state-of-the-art engineering and advanced design to create the finest convection oven. In standard convection ovens, a fan simply circulates the hot air around the food. The system is characterized by the combination of an additional heating element located around the convection fan and the venting panel that distributes heated air in three dimensions: along the sides, the top, and the full depth of the oven cavity. This European Convection system aids in maintaining a more even oven temperature throughout the oven cavity.

The circulating air aids in speeding up the baking process and cooks the food more evenly. By controlling the movement of heated air, convection cooking produces evenly browned foods that are crispy on the outside yet moist inside. Convection cooking works best for breads and pastries as well as meats and poultry. Air-leavened foods like Angel food cakes, soufflés, and cream puffs rise higher than in a conventional oven. Meats stay juicy and tender while the outside is flavorful and crisp.

By using European Convection, foods can be cooked at a lower temperature and cooking times can be shorter.

When using this mode, the standard oven temperature should be lowered by 25 °F (15 °C). Foods requiring less cooking time should be checked slightly earlier than normal. For best results, foods should be cooked uncovered, in low-sided pans to take advantage of the forced air circulation. When using the Convection Roast mode, the standard oven temperature does not need to be reduced.

ADVANTAGES OF CONVECTION COOKING

- Baking on multiple racks at the same time is possible with even results.
- Multiple-rack baking saves time.
- Prepare whole meals at once with no flavor transfer
- Requires no specialized bake ware.
- Dehydrates herbs, fruits and vegetables
- Saves time and energy.
- Convection broiling allows for extraordinary grilling with thicker cuts of food.

OVEN MODES

Selects the oven function. Each of the functions listed below can be used only with the correct temperature.



Bake Mode

The top and bottom heating elements will appear. This is the classic, traditional type of oven which has been perfected, with exceptional heat distribution and reduced energy consumption. The convection oven is still unequaled when it comes to cooking dishes made up of several ingredients, e.g. cabbage with ribs, etc. Excellent results are achieved when preparing veal or beef-based dishes which need to cook slowly and require basting or the addition of liquid. It nonetheless remains the best system for baking cakes as well as fruit and cooking using covered casserole dishes for oven baking. When cooking in Bake mode, only use one drip pan or cooking rack at a time, otherwise the heat distribution will be uneven. Using the different rack heights available, you can balance the amount of heat between the top and the bottom of the oven. Select from among the various rack heights based on whether the dish needs more or less heat from the top.



High Broil

The top central heating elements comes on. The extremely high and direct temperature of the grill makes it possible to brown the surface of meats and roasts while locking the juices in to keep them tender. High Broil is also highly recommended for dishes that require a high temperature on the surface: beef steaks, veal, rib steak, filets, hamburgers etc.

Cook food with the oven door ajar.

Some grilling examples are included in the "Practical Cooking Advice" paragraph.



Convection Broil

The top central heating elements and the fan appear. This combination of features increases the effectiveness of the unidirectional thermal radiation of the heating elements through forced circulation of the air throughout the oven. This helps prevent food from burning on the surface, allowing the heat to penetrate right into the food. Excellent results are achieved with kebabs made with meats and vegetables, sausages, ribs lamb chops, chicken in a spicy sauce, quail, pork chops, etc.

Cook food in Convection Broil mode with the oven door shut.

This mode is also ideal for cooking fish steaks, like swordfish, stuffed cuttlefish etc.



Convection Bake

The bottom and circle heating elements, as well as the fan, will appear. This combination rapidly heats the oven due to the large amounts of power used by the appliance, which results in the production of considerable heat coming prevalently from the bottom.

The Convection Bake mode is ideal for foods requiring high temperatures to cook, like pizzas and large roasts. Only use one oven tray or rack at a time. However, if more than one is used, these must be turned halfway through the cooking process.



True European Convection

The rear heating element and the fan appear. Delicate heat is distributed uniformly throughout the oven.

This mode is ideal for baking and cooking delicate foods-especially cakes that need to rise-and for the preparation of certain tartlets on 3 shelves at the same time. Here are a few examples: cream puffs, sweet and savory biscuits, savory puffs, Swiss rolls and small portions of vegetables au gratin, etc.



Convection Roast Mode

The top and bottom heating elements, as well as the fan, will appear, guaranteeing constant heat distributed uniformly throughout the oven.

This mode is especially recommended for cooking prepacked food quickly (as pre-heating is not necessary), such as for example: frozen or pre-cooked food) as well as for a few "home-made" dishes.

The best results when cooking using the Convection Roast mode are obtained if you use one pan only; placed on the second rack from the bottom. See the table entitled "Practical Cooking Advice".



Pizza

The bottom heating element and the fan appear. Suitable for pastries, cakes and non-dry sweets in baking tins or moulds. Excellent results are also obtained in cooking requiring above all heat from the bottom.

You are advised to put the pan on a low level.



Low Broil

The top heating elements comes on. This mode can be used to brown food at the end of cooking.



Multi-Cooking Mode

The top and bottom heating elements, as well as the fan, will appear alternately. Since the heat remains constant and uniform throughout the oven, the air cooks and browns food uniformly over its entire surface. With this mode, you can also cook various dishes at the same time, as long as their respective cooking temperatures are the same. A maximum of 2 racks can be used at the same time, following the instructions in the section entitled: "Cooking On More Than One Rack".

This cooking mode is particularly recommended for dishes requiring a gratin finish or for those requiring considerably prolonged cooking times, such as for example: lasagne, pasta backs, roast chicken and potatoes, etc. Moreover the excellent heat distribution makes it possible to use lower temperatures when cooking roasts. This results in less loss of juices, meat which is more tender and a decrease in the loss of weight for the roast. The Multi-cooking mode is especially suited for cooking fish, which can be prepared with the addition of a limited amount of condiments, thus maintaining their flavor and appearance. Excellent results can be attained when cooking vegetable-based side dishes like courgettes, aubergines, peppers, etc.

Desserts: this mode is also perfect for baking leavened cakes.

Moreover, this mode can also be used to thaw quickly white or red meat and bread by setting the temperature to 80. To thaw more delicate foods, set the thermostat to 60 or use only the cold air circulation feature by setting the thermostat to 0.



Defrost Mode

The fan only appears. The fan located on the bottom of the oven makes the air circulate at room temperature around the food. This is recommended for the defrosting of all types of food, but in particular for delicate types of food which do not require heat, such as for example: ice cream cakes, cream or custard desserts, fruit cakes. By using the fan, the defrosting time is approximately halved. In the case of meat, fish and bread, it is possible to accelerate the process using the "Baking" mode and setting the temperature to 80-100.

COOLING VENTILATION

In order to cool down the exterior of the appliance, this model is equipped with a cooling fan, which comes on automatically when the oven is hot.

When the fan is on, a normal flow of air can be heard exiting between the oven door and the control panel.

NOTE: When cooking is done, the fan stays on until the oven cools down sufficiently.

QUICK TIPS

CONVECTION COOKING

ABOUT CONVECTION COOKING

Standard cooking modes (Bake, Broil, etc.) use heat radiated from one or more elements to cook food. Convection modes use both heat from the elements and fans in the back of the oven to continuously circulate the heated air throughout the oven.

ADVANTAGES OF CONVECTION COOKING

- Even baking, browning and crisping.
- Juices and flavors are sealed in.
- Air leavened foods such as cream puffs, soufflés, meringues and breads are higher and lighter.
- Multiple rack cooking.
- No special bake ware required.
- Saves time and energy.

DO NOT use Convection Bake for meats. Use Convection Roast instead.

Mode	Use this mode for:	For Best results	Quick Cooking Tip
Convection Bake	<ul style="list-style-type: none"> • Large quantities of food on multiple racks. • Pastries, breads, snack, foods and appetizers. 	<ul style="list-style-type: none"> • Use low-sided, uncovered pans. • Center baking sheets side to side on the oven rack. 	<ul style="list-style-type: none"> • Reduce recipe temperature by 25°F (15 °C). • Check food for doneness early: <p>If recipe calls for Check food</p> <p>1 - 15 min. - 3 min. early 6 - 30 min. - 5 min. early 31 min.-1hr. - 10 min. early</p>

Convection Broil	<ul style="list-style-type: none"> • Thicker, tender, cuts of meat, poultry and fish. • DO NOT use this mode for browning breads or casseroles. 	<ul style="list-style-type: none"> • Meats should be at least 1" thick. 	<ul style="list-style-type: none"> • No conversion from standard Broil is necessary. • Refer to Convection Broil Chart in this Manual for cooking times.
Convection Roast	<ul style="list-style-type: none"> • Large, tender cuts of meat and poultry such as roast or whole chicken. 	<ul style="list-style-type: none"> • DO NOT cover meat or use cooking bags • Refer to Convection Roast Chart in this Manual for cooking times 	<ul style="list-style-type: none"> • Do NOT change recipe temperature

CONVECTION BAKE TIPS AND TECHNIQUES

Reduce recipe baking temperatures by 25°F (15°C).

- For best results, foods should be cooked uncovered, in low-sided pans to take advantage of the forced air circulation. Use shiny aluminum pans for best results unless otherwise specified.
- Heatproof glass or ceramic can be used. Reduce temperature by another 25°F (15 °C) when using heatproof glass dishes for a total reduction of 50 °F (30 °C).
- Dark metal pans may be used. Note that food may brown faster when using dark metal bake ware.
- The number of racks used is determined by the height of the food to be cooked.
- Baked items, for the most part, cook extremely well in convection. Do not try to convert recipes such as custards, quiches, pumpkin pie, or cheesecakes, which do not benefit from the convection-heating process. Use the regular Bake mode for these foods.
- Multiple rack cooking for oven meals is done on rack positions 1, 2, 3, 4 and 5. All five racks can be used for cookies, biscuits and appetizers.
 - 2 rack baking: Use positions 1 and 3.
 - 3 rack baking: Use positions 2, 3 and 4 or 1, 3 and 5.
 - When baking four cake layers at the same time, stagger pans so that one pan is not directly above another. For best results, place cakes on front of upper rack and back of lower rack (See graphic at right). Allow 1" - 1½" (2.5 - 3 cm) air space around pans.

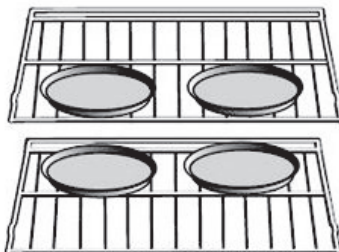

Rack 3

Rack 1

- Converting your own recipe can be easy. Choose a recipe that will work well in convection.
- Reduce the temperature and cooking time if necessary. It may take some trial and error to achieve a perfect result. Keep track of your technique for the next time you want to prepare the recipe using convection.

FOODS RECOMMENDED FOR CONVECTION BAKE MODE:

Appetizers Biscuits Coffee Cakes, Cookies (2 to 4 racks)
Yeast Breads, Cream Puffs, Popovers, Casseroles, and
One-dish Entrées, Oven Meals (rack positions 1, 2,
3), Air-leavened Foods (Soufflés, Meringue-Topped
Desserts, Angel Food Cakes, Chiffon Cakes)

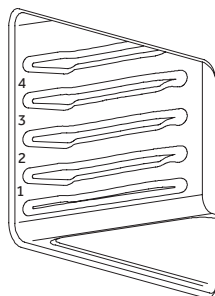

QUICK AND EASY RECIPE TIPS

Converting from standard BAKE to CONVECTION BAKE:

- Reduce the temperature by 25°F (15 °C).
- Use the same baking time as Bake mode if under 10 to 15 minutes.
- Foods with a baking time of less than 30 minutes should be checked for doneness 5 minutes earlier than in standard bake recipes.
- If food is baked for more than 40 to 45 minutes, bake time should be reduced by 25%.

CONVECTION BAKE CHART

- Reduce standard recipe temperature by 25°F (15 °C) for Convection Bake.
- Temperatures have been reduced in this chart.

FOOD ITEM	RACK POSITION	TEMP. °F (°C) (PREHEATED OVEN)	TIME (Min.)
Cake			
Cupcakes	2	325 (165)	16-20
Bundt Cake	1	325 (165)	37-43
Angel Food	1	325 (165)	25-35
Pie			
2 crust, fresh, 9"	2	350-400 (175-205)	35-45
2 crust, frozen fruit, 9"	2	350 (175)	68-78
Cookies			
Sugar	2	325-350 (165-175)	8-12
Chocolate Chip	2	325-350 (165-175)	10-15
Brownies	2	325 (165)	25-30

Breads			
Yeast bread loaf, 9x5	2	350 (175)	15-22
Yeast rolls	2	350-375 (175-190)	10-15
Biscuits	2	375 (190)	6-10
Muffins	2	400 (205)	13-16
Pizza (Multiple rack cooking)			
Frozen	1 and 3	375-425 (190-220)	12-18
Fresh	1 and 3	375-425 (190-220)	8-14

The TEMP and TIME in the chart above are for the 240 V setting. This chart is a guide. Follow recipe or package directions and adjust temperatures / time appropriately.

BAKE TIPS AND TECHNIQUES

Baking is cooking with heated air. Both upper and lower elements in the oven are used to heat the air but no fan is used to circulate the heat.

Follow the recipe or convenience food directions for baking temperature, time and rack position. Baking time will vary with the temperature of ingredients and the size, shape and finish of the baking utensil.

GENERAL GUIDELINES

- For best results, bake food on a single rack with at least 1" - 1-½" (2,5 - 3 cm) space between utensils and oven walls.
- Use one rack when selecting the Bake Mode.
- Check for doneness at the minimum time.
- Use metal bake ware (with or without a non-stick finish), heatproof glass, glass-ceramic, pottery or other utensils suitable for the oven.
- When using heatproof glass, reduce temperature by 25 °F (15 °C) from recommended temperature.
- Use baking sheets with or without sides or jelly roll pans.
- Dark metal pans or nonstick coatings will cook faster with more browning. Insulated bake ware will slightly lengthen the cooking time for most foods.
- Do not use aluminum foil or disposable aluminum trays to line any part of the oven. Foil is an excellent heat insulator and heat will be trapped beneath it. This will alter the cooking performance and can damage the finish of the oven.
- Avoid using the opened oven door as a shelf to place pans.

BAKE CHART

FOOD ITEM	RACK POSITION	TEMP. °F (°C) (PREHEATED OVEN)	TIME (Min.)
Cake			
Cupcakes	2	350 (175)	19-22
Bundt Cake	1	350 (175)	40-45
Angel Food	1	350 (175)	35-39
Pie			
2 crust, fresh, 9"	2	375-400 (190-205)	45-50
2 crust, frozen fruit, 9"	2	375 (190)	68-78
Cookies			
Sugar	2	350-375 (175-190)	8-10
Chocolate Chip	2	350-375 (175-190)	8-13
Brownies	2	350 (175)	29-36
Breads			
Yeast bread loaf, 9x5	2	375 (190)	18-22
Yeast rolls	2	375-400 (190-205)	12-15
Biscuits	2	375-400 (190-205)	7-9
Muffins	2	425 (220)	15-19

The TEMP and TIME in the chart above are for the 240 V setting.

This chart is a guide. Follow recipe or package directions and adjust temperatures / time appropriately.

CONVECTION BROIL TIPS AND TECHNIQUES

- Place rack in the required position needed before turning on the oven.
- Use Convection Broil mode with the oven door closed.
- Do not preheat oven. (This means, "PREHEAT" indication automatically appears when the Convection Broil mode is selected, so place food inside the oven before selecting the Cooking mode)
- Use the 2-piece broil pan. (Without the 2-piece pan there may be a risk of fire with drip of the fat from the meat).
- Turn meats once halfway through the cooking time (see Convection Broil Chart).

CONVECTION BROIL CHART

FOOD AND THICKNESS	RACK POSITION	OVEN TEMP °F (°C)	TIME SIDE 1 (Min.)*	TIME SIDE 2 (Min.)*
Beef				
Steak (1" or more)				
Medium rare	4	450 (230)	10-12	10-12
Medium	4	450 (230)	15-17	13-15
Well	4	450 (230)	16-18	13-15
Hamburgers (1" or more)				
Medium	4	550 (290)	9-11	5-8
Well	4	550 (290)	11-13	8-10
Poultry				
Chicken Quarters	4	450 (230)	18-20	13-15
Chicken Halves	3	450 (230)	25-27	15-18
Chicken Breasts	4	450 (230)	14-16	10-14
Pork				
Pork Chops (1¼" or more)	4	450 (230)	13-15	12-14
Sausage - fresh	4	450 (230)	4-6	3-5

The TEMP. and TIME in the chart above are for the 240 V setting.

* Broiling and convection broiling times are approximate and may vary slightly.

Cooking times are indicative and also depend on the thickness and the starting temperature of the meat before cooking.

BROIL TIPS AND TECHNIQUES

- Place rack in the required position needed before turning on the oven.
- Use Broil mode with the oven door closed.
- Preheat oven for 5 minutes before use.
- Use the 2-piece broil pan. (Without using a 2-piece pan may have risk of fire with drip of the fat from the meat.

NOTE: For best results use only the center $\frac{2}{3}$ of the width of the broil pan.

- Turn meats once halfway through the cooking time (see Broil Chart).

BROIL CHART

Food and Thickness	Rack Position	Broil Setting	Time Side 1 (Min.)*	Time Side 2 (Min.)*
Beef				
Steak (1" or more) Medium rare	5	L 5	5-7	4-6
Medium	5	L 5	6-8	5-7
Well	5	L 5	8-10	7-9
Hamburgers (1" or more) Medium	4	L 5	8-13	11
Well	4	L 5	10-15	8-12
Poultry				
Breast (bone-in)	4	L 4	10-12	8-10
Thigh (very well done)	4	L 3	28-30	13-15
Pork				
Pork Chops (1")	5	L 5	7-9	5-7
Sausage - fresh	5	L 5	5-7	3-5
Ham Slice (1/2")	5	L 5	4-6	3-5
Seafood				
Fish Filets, 1" Buttered	4	L 4	10-14	N/A
Lamb Chops (1")				
Medium Rare	5	L 5	5-7	4-6
Medium	5	L 5	6-8	4-6
Well	5	L 5	7-9	5-7
Bread				
Garlic Bread, 1" slices	4	L 5	2-3	N/A
Garlic Bread, 1" slices	3	L 5	4-6	

The BROIL SETTING and TIME in the chart above are for the 240 V setting.

* Broiling and convection broiling times are approximate and may vary slightly.

Cooking times are indicative and also depend on the thickness and the starting temperature of the meat before cooking.

Food Service Temperature Guidelines from FSIS (USDA food Safety & Inspection Service)			
140 °F (60 °C)	Ham, precooked (to Reheat)	165 °F (74 °C)	Stuffing (cooked alone or in bird)
145 °F (63 °C)	Fresh beef, Veal, Lamb (medium rare)		Leftovers & Casseroles
160 °F (71 °C)	Ground Meat & Meat mixtures (Beef, Pork, Veal, Lamb)	170 °F (77 °C)	Fresh beef, Veal, Lamb (well done)
	Fresh beef, Veal, Lamb (medium)		Poultry breast
	Fresh Pork (medium)		Fresh Pork (well done)
	Fresh Ham (raw)	180 °F (82 °C)	Chicken and Turkey (Whole)
	Egg Dishes		Poultry (thighs and wings)
165 °F (74 °C)	Ground Meat & Meat mixtures (Turkey, Chicken)		Duck and Goose

NOTE: Eggs (alone, not used in a recipe) – cook until yolk & white are firm

CONVECTION ROAST TECHNIQUES

- Do not preheat for Convection Roast. (This mean, "PREHEAT" indication is automatically appear when the Convection Roast mode is selected, but place food inside the oven before selecting the Cooking mode.)
- Roast in a low-sided, uncovered pan.
- When roasting whole chickens or turkey, tuck wings behind back and loosely tie legs with kitchen string.
- Use the 2-piece broil pan for roasting uncovered. (Without the 2-piece pan, may have risk of fire with the drip of the fat from the meat.)

WARNING



Burn Hazard

Use an oven mitt to remove temperature probe.

Do not touch broil element.

Failure to do so can result in burns.

- Use the probe or a meat thermometer to determine the doneness by checking internal temperature (see Convection Roast Chart).

- Double-check the internal temperature of meat or poultry by inserting meat thermometer into another position.
- Large poultry may also need to be covered with foil (and pan roasted) during a portion of the roasting time to prevent over-browning.
- The minimum safe internal temperature for stuffing in poultry is 165°F (74°C).
- After removing the item from the oven, cover loosely with foil for 10 to 15 minutes before carving, if necessary, to increase the final foodstuff temperature by 5° to 10 °F (3° to 6° C).

QUICK AND EASY RECIPE TIPS

Converting from standard bake to convection roast:

- Temperature does not have to be lowered.
- Roasts, large cuts of meat and poultry generally take 10-20% less cooking time. Check doneness early.
- Casseroles or pot roasts that are baked covered in CONVECTION ROAST will cook in about the same amount of time.

CONVECTION ROAST CHART

MEATS	WEIGHT lb (kg)	RACK POSITION	OVEN TEMP °F (°C)	TIME (Min. per lb)	INTERNAL TEMP. °F (°C)
Beef					
Rib Roast	4-6 (2-3)	2	325 (165)	18-22 20-25	145 (63) medium rare 160 (71) medium
Rib Eye Roast, (boneless)	4-6 (2-3)	2	325 (165)	18-22 20-25	145 (63) medium rare 160 (71) medium
Rump, Eye, Tip, Sirloin (boneless)	3-6 (1,5-3)	2	325 (165)	18-22 20-25	145 (63) medium rare 160 (71) medium
Tenderloin Roast	2-3 (1-1,5)	2	425 (220)	15-20	145 (63) medium rare
Pork					
Loin Roast (boneless or bone-in)	5-8 (2,5-4)	2	350 (175)	18-22	160 (71) medium
Shoulder	3-6 (1,5-3)	2	350 (175)	20-25	160 (71) medium

Poultry					
Chicken whole, not stuffed	3-4 (1,5-2)	2	375 (190)	20-23	180 (82)
Turkey, not stuffed	12-15 (6-7,5)	1	325 (165)	10-14	180 (82)
Turkey, not stuffed	16-20 (8-10)	1	325 (165)	9-11	180 (82)
Turkey, not stuffed	21-25 (10,5-12,5)	1	325 (165)	6-10	180 (82)
Turkey Breast	3-8 (1,5-4)	1	325 (165)	15-20	170 (77)
Cornish Hen	1 - 1½ (0,5-0,75)	2	350 (175)	45-75 total	180 (82)
Lamb					
Half Leg	3-4 (1,5-2)	2	325 (165)	20-27 25-32	160 (71) medium 170 (77) well
Whole Leg	6-8 (3-4)	1	325 (165)	20-27 25-32	160 (71) medium 170 (77) well

The TEMP and TIME in the chart above are for the 240 V setting.

Cooking times are indicative and also depend on the thickness and the starting temperature of the meat before cooking.

GENERAL OVEN CARE

HOW TO USE THE CLEANING CHART

1. Locate the number of the part to be cleaned in the illustration below.
2. Find the part name in the Cleaning Chart.
3. Match the letter with the cleaning method on following page.

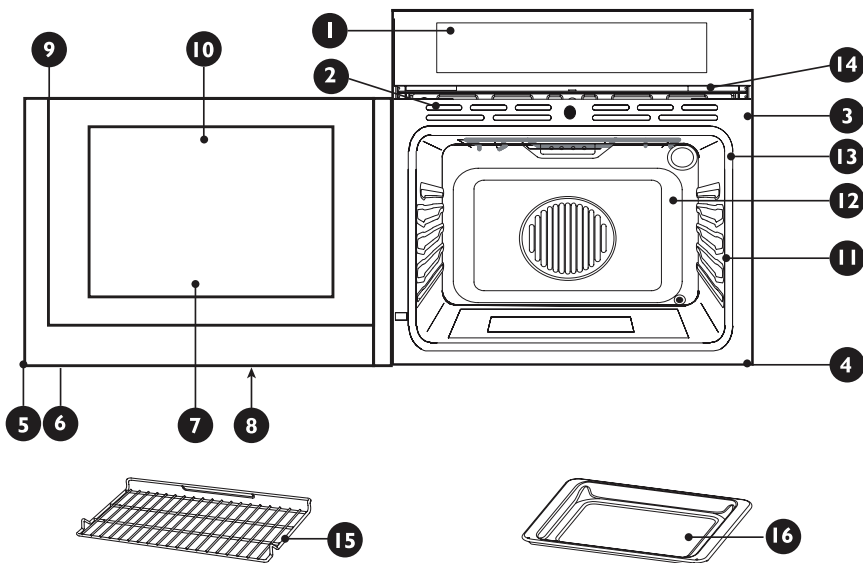

CLEANING CHART

Part		Cleaning Method			
		Stainless Steel Oven	Stainless Steel Oven		
1	Control Panel	C-G	9	End Caps	D
2	Door Cooling Vent	E	10	Interior Oven Door	E
3	Side Trim	D	11	Oven Front Frame	E
4	Bottom Trim	D	12	Oven Cavity	E
5	Door Frame	E	13	Door Gasket	B
6	Door Handle	G	14	Oven Cooling Vents	D
7	Interior Door Windows	F	15	Oven Rack	A
8	Door Front	C&G	16	Drip Pan	E

Please refer to the following chart for Cleaning Method.

OVEN FINISHES / CLEANING METHODS

The entire oven can be safely cleaned with a soapy sponge, rinsed and dried. If stubborn soil remains, follow the recommended cleaning methods below.

- Always use the mildest cleaner that will do the job.
- Rub metal finishes in the direction of the grain.
- Use clean, soft cloths, sponges or paper towels.
- Rinse thoroughly with a minimum of water so it does not drip into door slots.
- Dry to avoid water marks.

The cleaners listed below indicate types of products to use and are not being endorsed. Use all products according to package directions.

Part	Cleaning Method
A Chrome Plated	Wash with hot sudsy water. Rinse thoroughly and dry. Or, gently rub with Soft Scrub [®] , Bon-Ami [®] , Comet [®] , Ajax [®] , Brillo [®] or S.O.S. [®] pads as directed. Easy Off [®] or Dow [®] Oven Cleaners (cold oven formula) can be used, but may cause darkening and discoloration. Racks may be cleaned in the oven during the Self-Cleaning mode. However, chromed racks will lose their shiny finish and permanently change to a metallic gray.
B Fiberglass Knit	DO NOT HAND CLEAN GASKET.
C Glass	Spray Windex [®] or Glass Plus [®] onto a cloth first, then wipe to clean. Use Fantastik [®] or Formula 409 [®] to remove grease spatters.
D Painted	Clean with hot sudsy water or apply Fantastik [®] or Formula 409 [®] first to a clean sponge or paper towel and wipe clean. Avoid using powdered cleansers and steel wool pads.
E Porcelain	Immediately wipe up acidic spills like fruit juice, milk and tomatoes with a dry towel. Do not use a moistened sponge/towel on hot porcelain. When cool, clean with hot sudsy water or apply Bon-Ami [®] or Soft Scrub [®] to a damp sponge. Rinse and dry. For stubborn stains, gently use Brillo [®] or S.O.S. [®] pads. It is normal for porcelain to craze (fine lines) with age due to exposure from heat and food soil.
F Reflective Glass	Clean with hot sudsy water and sponge or plastic scrubber. Rub stubborn stains with vinegar, Windex [®] , ammonia or Bon-Ami [®] DO NOT USE HARSH ABRASIVES.
G Stainless	Always wipe or rub with grain. Clean with a soapy sponge then rinse and dry. Or, wipe with Fantastik [®] or Formula 409 [®] sprayed onto a paper towel. Protect and polish with Stainless Steel Magic [®] and a soft cloth. Remove water spots with a cloth dampened with white vinegar. Use Zud [®] , Cameo [®] , Bar Keeper's Friend [®] or RevereWare Stainless Steel Cleaner [®] , to remove heat discoloration.

OVEN DOOR REMOVAL

The oven door weighs 30 lbs (14kg). For easier installation and more thorough cleaning, some oven doors may be removed.

When removing the door:

- Make sure oven is cool and power to the oven has been turned off before removing the door. Failure to do so could result in electrical shock or burns.
- The oven door is heavy and fragile. Use both hands to remove the oven door. The door front is glass. Handle carefully to avoid breaking.
- Grasp only the sides of the oven door. Do not grasp the handle as it may swing in your hand and cause damage or injury.
- Failure to grasp the oven door firmly and properly could result in personal injury or product damage.
- To avoid injury from hinge bracket snapping closed, be sure that both levers are securely in place before removing the door. Also, do not force door open or closed-the hinge could be damaged and injury could result.

Remove the glass panel:

The glass panels on the door can be removed to assist in cleaning.

1. Open the oven door.
2. Grasp the bottom of the inner glass panel and pull out to remove.
3. Remove the center glass panel.
4. Reassemble the door by reversing the above steps.

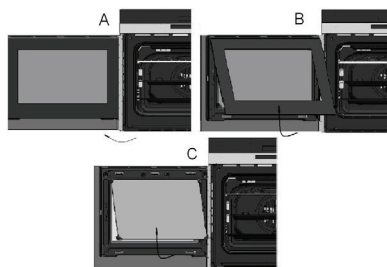

REPLACING AN OVEN LIGHT

WARNING



Electrical Shock Hazard

Make sure the oven and lights are cool and power to the oven has been turned off before replacing the light bulb(s).

The lenses must be in place when using the oven. The lenses serve to protect the light bulb from breaking.

The lenses are made of glass. Handle carefully to avoid breakage.

Failure to do so could result in death, electric shock, cuts or burns.

TO REPLACE A LIGHT BULB

Before replacing, make sure the oven is off and cool.

1. Disconnect power at the main power supply (fuse or breaker box).
2. Remove the glass cover of the lamp-holder.
3. Remove the lamp and replace with a lamp resistant to high temperatures with the following characteristics:
 - Voltage: 208-240V
 - Wattage: 25W
 - Type: E 14
4. Replace the glass cover.
5. Turn power back on at the main power supply (fuse or breaker box).

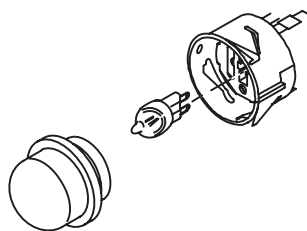

TROUBLESHOOTING

SOLVING BAKING AND ROASTING PROBLEMS

With either Bake or Convection Bake and Convection Roast poor results can occur for many reasons other than a malfunction of the oven. Check the chart below for causes of the most common problems. Since the size, shape and material of baking utensils directly affect the baking results, the best solution may be to replace old baking utensils that have darkened and warped with age and use. Check the Baking Charts.

Baking and Roasting Problem	Cause
Food browns unevenly	<ul style="list-style-type: none"> • Oven not preheated • Aluminum foil on oven rack or oven bottom • Baking utensil too large for recipe • Pans touching each other or oven walls
Food too brown on bottom	<ul style="list-style-type: none"> • Oven not preheated • Using glass, dull or darkened metal pans • Incorrect rack position • Pans touching each other or oven walls
Food is dry or has shrunk excessively	<ul style="list-style-type: none"> • Oven temperature too high • Baking time too long • Oven door opened frequently • Pan size too large
Food is baking or roasting too slowly	<ul style="list-style-type: none"> • Oven temperature too low • Oven not preheated • Oven door opened frequently • Tightly sealed with aluminum foil • Pan size too small
Piecrusts do not brown on bottom or crust is soggy	<ul style="list-style-type: none"> • Baking time not long enough • Using shiny steel pans • Incorrect rack position • Oven temperature is too low
Cakes pale, flat and may not be done inside	<ul style="list-style-type: none"> • Oven temperature too low Incorrect baking time • Cake tested too soon • Oven door opened too often • Pan size may be too large

Cakes high in middle with crack on top	<ul style="list-style-type: none"> • Oven temperature too high • Baking time too long • Pans touching each other or oven walls • Incorrect rack position • Pan size too small
Piecrust edges too brown	<ul style="list-style-type: none"> • Oven temperature too high • Edges of crust too thin

SOLVING OPERATIONAL PROBLEMS

Before calling for service, check the following to avoid unnecessary service charges.

Oven Problem	Problem Solving Steps
The oven display stays OFF	Turn off power at the main power supply (fuse or breaker box). Turn breaker back on. If condition persists, call an authorized service center.
Cooling fan continues to run after oven is turned off	The fan turns off automatically when the electronic components have cooled sufficiently.
Oven is not heating	Check the circuit breaker or fuse box to your house. Make sure there is proper electrical power to the oven. Make sure the oven temperature has been selected.
Oven is not cooking evenly	Check oven calibration. Adjust calibration if necessary. Refer to cook charts for recommended rack position. Always reduce recipe temperature by 25 °F (15 °C) when baking with Convention Bake mode.
Oven temperature is too hot or too cold	The oven thermostat needs adjustment. See Calibrating Oven Temperature.
Oven light is not working properly	Replace or reinsert the light bulb if loose or defective. Touching the bulb with fingers may cause the bulb to burn out.
Oven light stays on	Check for obstruction in oven door. Check to see if hinge is bent or door switch broken.
Cannot remove lens cover on light	There may be a soil build-up around the lens cover. Wipe lens cover area with a clean dry towel prior to attempting to remove the lens cover.
Clock and timer are not working properly	Make sure there is proper electrical power to the oven. See the Clock and Timer sections.
Excessive moisture	When using bake mode, preheat the oven first. Convection Bake and Convection Roast will eliminate any moisture in oven (this is one of the advantages of convection).
Porcelain chips	When oven racks are removed and replaced, always tilt racks upward and do not force them to avoid chipping the porcelain.

FOR MORE HELP, VISIT HAIER.COM OR CALL THE CONSUMER HELP LINE AT 1-877-377-3639.

LIMITED WARRANTY

IN-HOME SERVICE

FULL TWO YEAR WARRANTY

For 24 months from the date of original retail purchase, Haier will repair or replace any part free of charge including labor that fails due to a defect in materials or workmanship.

Haier may replace or repair at their sole discretion any part, sub system including the entire product.

Product must be accessible, without encumbrance and installed properly to receive for warranty repair service.

LIMITED WARRANTY

NOTE: This warranty commences on the date the item was purchased, and the original purchase receipt must be presented to the authorized service representative before warranty repairs are rendered.

Exceptions: Commercial Use Warranty

90 days labor from date of original purchase

90 days parts from date of original purchase

No other warranty applies.

FOR WARRANTY SERVICE

All service must be performed by a Haier authorized service center. For the name and telephone number of the nearest authorized service center, please call 1-877-337-3639.

Before calling please have available the following information:

Model number and serial number of your appliance. The name and address of the dealer you purchased the unit from and the date of purchase.

A clear description of the problem.

A proof of purchase (sales receipt).

This warranty covers home appliance services within the contiguous United States and Canada and where available in Alaska, Hawaii and Puerto Rico.

What is not covered by this warranty:

Replacement or repair of household fuses, circuit breakers, wiring or plumbing.

A product whose original serial number has been removed or altered.

Any service charges not specifically identified as normal such as normal service area or hours.

Replacement of light bulbs.

Damage to clothing.

Damage incurred in shipping.

Damage caused by improper installation or maintenance.

Damage from misuse, abuse accident, fire, flood, or acts of nature.

Damage from service other than an authorized Haier dealer or service center.

Damage from incorrect electrical current, voltage or supply.

Damage resulting from any product modification, alteration or adjustment not authorized by Haier.

Adjustment of consumer operated controls as identified in the owner's manual.

Hoses, knobs, lint trays and all attachments, accessories and disposable parts.

Labor, service transportation, and shipping charges for the removal and replacement of defective parts beyond the initial 24-month period.

Damage from other than normal household use.

Any transportation and shipping charges.

THIS LIMITED WARRANTY IS GIVEN IN LIEU OF ALL OTHER WARRANTIES, EXPRESS ED OR IMPLIED, INCLUDING BUT NOT LIMITED TO, THE WARRANTIES OF MERCHANTABILITY AND FITNESS FOR A PARTICULAR PURPOSE

The remedy provided in this warranty is exclusive and is granted in lieu of all other remedies.

This warranty does not cover incidental or consequential damages, so the above limitations may not apply to you. Some states do not allow limitations on how long an implied warranty lasts, so the above limitations may not apply to you.

This warranty gives you specific legal rights, and you may have other rights, which vary from state to state.

Haier America
Wayne, NJ 07470

IMPORTANT

Do Not Return This Product To The Store
If you have a problem with this product, please contact the
"Haier Customer Satisfaction Center" at
1-877-337-3639.

DATED PROOF OF PURCHASE, MODEL #, AND SERIAL #
REQUIRED FOR WARRANTY SERVICE

IMPORTANT

Ne pas Réexpédier ce Produit au Magasin
Pour tout problème concernant ce produit, veuillez contacter
le service des consommateurs "Haier Customer Satisfaction Center" au
1-877-337-3639.

UNE PREUVE D'ACHAT DATEE EST REQUISE POUR BENEFICIER DE LA GARANTIE.

IMPORTANTE

No regrese este producto a la tienda
Si tiene algún problema con este producto, por favor contacte el
"Centro de Servicio al Consumidor de Haier" al
1-877-337-3639 (Válido solo en E.U.A).
NECESITA UNA PRUEBA DE DE COMPRA FECHADA, NÚMERO DE MODELO
Y DE SERIE PARA EL SERVICIO DE LA GARANTÍA

Made in China
Fabriqué en Chine
Hecho en China

Haier

Haier America
Wayne, NJ 07470

HCW225LAES
HCW225RAES
Issued: March 2015

Printed in China

Part # 00XXXXXXXXX