

# WINE STORAGE

## **USER GUIDE & SERVICE MANUAL**

CLEANING, MAINTENANCE, AND MORE



**TITAN**

TT-BW248413SZ ■ 24" Single Zone Single Door Beverage and Wine Cooler



## Table of Contents

Intro	1
-------	---

### Safety and Warning

Instructions Before Using	2
Important Safety Instructions	2

### Installation

Environmental Requirements	4
Electrical	5
Cutout Dimensions	6
Installation Clearance Requirements	7
Product Dimensions	8
Product Storage	9
Product Specifications	10
General Installation	11
Types of Installation	12
Handle&Shelf Installation	13
Shelf Installation	14
Door Swing Installation	15

### Operation Instructions

Control Operation	15
Sounds	19
Defrosting	19

### Maintenance

Cleaning	20
Troubleshooting	22
Warranty	23

---

## Welcome To Titan Appliances

Congratulations on purchasing your Titan appliance! We at Titan offer quality products that compliment your lifestyle. To learn more about our products please visit our website at [www.titan-appliances.com](http://www.titan-appliances.com).

This manual contains information on how to install, use and maintain your appliance to perform at its peak efficiency.

To safely transport your appliance in future, please save the original product packaging.

Before contacting customer service, please ensure that you have done the following:

### **Proof of Purchase:**

For future reference, please write down the model number and serial number below.

Model Number:

Serial Number:

Date of Purchase:

Both the model number and the serial number are located on the product label on the back of your unit and are needed for service under warranty. We suggest stapling your receipt to this manual as it serves as the proof of your purchase and will be needed for service under your warranty.

Before contacting customer service, please ensure that you have done the following:

1. If the unit is damaged upon receipt, please contact the retailer or dealer that sold you the appliance right away.
2. Please read this owner's manual and follow the instructions and recommendations to properly install, operate and maintain the unit.
3. Always refer to the trouble-shooting section of this owner's manual as it contains valuable information and suggestions on how to solve common issues.
4. For the latest information on this product and additional troubleshooting suggestions please visit our website at [www.titan-appliances.com](http://www.titan-appliances.com)
5. Should you need any help on the warranty service please contact our customer services at [service@titan-appliances.com](mailto:service@titan-appliances.com)

### **Contacts:**

Titan Products, LLC

[service@titan-appliances.com](mailto:service@titan-appliances.com)

## **SAFETY AND WARNING**

### **Instructions Before Using Your Appliance.**

Before use, make sure all packaging labels and materials are removed from the unit. Be sure to keep track of all included parts and pieces before discarding packaging materials. It is advised that you keep the original box and packaging materials in case you are ever to move or ship the appliance in the future.

Clean the interior surface with a clean soft cloth. Allow the unit to stand for at least 24 hours before use; this allows the cooling system time to settle from transit.

This owner's manual is provided for reference use only. Specifications may change without prior notice. Refer to the product label on the back of your unit for the latest technical information.

### **Important Safety Instructions**

Improper handling can cause serious damage to the Titan appliance and/or injury to the user. This appliance is designed for domestic indoor use only. Use of the unit for industrial or commercial or any other purposes will void the warranty.

#### **NOTICE**

**Please read all instructions before installing, operating, or servicing the appliance.**

Use this appliance for its intended purpose only and follow these general precautions with those listed throughout this guide:

#### **SAFETY ALERT DEFINITIONS**

Throughout this guide are safety items labeled with a Danger, Warning or Caution based on the risk types:

 **DANGER**

**Danger means that failure to follow this safety statement will result in severe personal injury or death.**

 **WARNING**

**Warning means that failure to follow this safety statement could result in serious personal injury or death.**

 **CAUTION**

**Caution means that failure to follow this safety statement may result in minor or moderate personal injury, property or equipment damage.**

 **DANGER**

**This unit contains R600a (Isobutane) which is a flammable hydrocarbon. It is safe for regular use. Do not use sharp objects to expedite defrosting. Do not service without consulting the "R600a specifications" section included in the User Guide. Do not damage the refrigerant circuit.**

 **WARNING**

**Service must be done by factory authorized service personnel. Any parts shall be replaced with like components. Failure to comply could increase the risk of possible ignition due to incorrect parts or improper service.**

 **DANGER**

**RISK OF CHILD ENTRAPMENT. Before you throw away your old refrigerator or freezer, take off the doors and leave shelves in place so children may not easily climb inside.**

If the unit is being removed from service for disposal, check and obey all federal, state and local regulations regarding the disposal and recycling of refrigeration appliances, and follow these steps completely:

- 1.Remove all consumable contents from the unit.
- 2.Unplug the electrical cord from its socket.
- 3.Remove the door(s) and shelves(s).

## INSTALLATION

### Environmental Requirements

This model is intended for indoor/interior applications only and is not to be used in installations that are open/exposed to natural elements.

This unit is designed to operate between 50°F and 95°F. Higher ambient temperatures may reduce the unit's ability to reach low temperatures and/or reduce ice production on applicable models.

For best performance, keep the unit out of direct sunlight and away from heat generating equipments.

In climates where high humidity and dew points are present, condensation may appear on outside surfaces. This is considered normal and does not affect the appliance's performance. The condensation will evaporate when the humidity drops.



**Damages caused by ambient temperatures of 40° F (4°C) or below are not covered by the warranty.**

## Electrical



**SHOCK HAZARD – Electrical Grounding Required.**

**Never attempt to repair or perform maintenance on the unit until the electricity has been disconnected.**

**Never remove the round grounding prong from the plug and never use a two-prong grounding adapter.**

**Altering, cutting or removing power cord, removing power plug, or direct wiring can cause serious injury, fire, loss of property and/or life, and will void the warranty.**

**Never use an extension cord to connect power to the unit.**

**Always keep your working area dry.**

### NOTICE

**Electrical installation must observe all state and local codes. This unit requires connection to a grounded (three-prong), polarized receptacle that has been placed by a qualified electrician.**

The unit requires a grounded and polarized 115 V, 60 Hz, 1.5A power supply (normal household current). An individual, properly grounded branch circuit or circuit breaker is recommended.



## Cutout Dimensions

### PREPARE SITE

Your Titan product has been designed for either free-standing or built-in installation. When built-in, your unit does not require additional air space for top, sides, or rear. However, the front grille must NOT be obstructed, and clearance is required for an electrical connection in the rear.



**Unit can NOT be installed behind a closed cabinet door.**

When installing the cooler under a counter, follow the recommended spacing dimensions shown.

- The cabinet should allow at least 24" for the width and 34" for the height to accommodate the beverage cooler.
- Once you are ready to install the unit, you must adjust the feet to level the cooler.

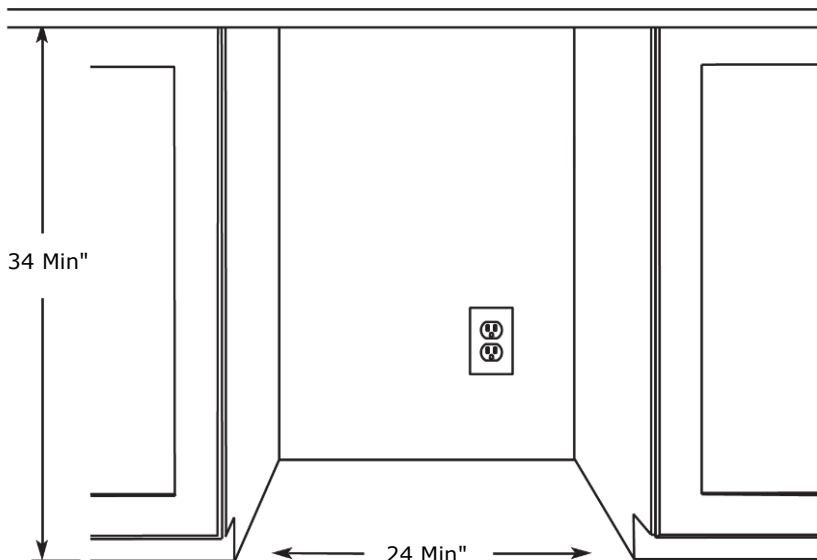

## Installation Clearance Requirements

When installing the cooler under a counter, follow the recommended spacing dimensions shown.

- To ensure proper service access and ventilation, allow at least 2-3" of clearance at the back as shown in the diagram.
- The installation should allow the unit to be pulled forward for servicing, if necessary.
- The power cable is located on the back right of the unit and has a length of 72" to accommodate multiple outlet locations.
- An installation next to a wall will require a minimum 2-1/4" door clearance to accommodate the handle

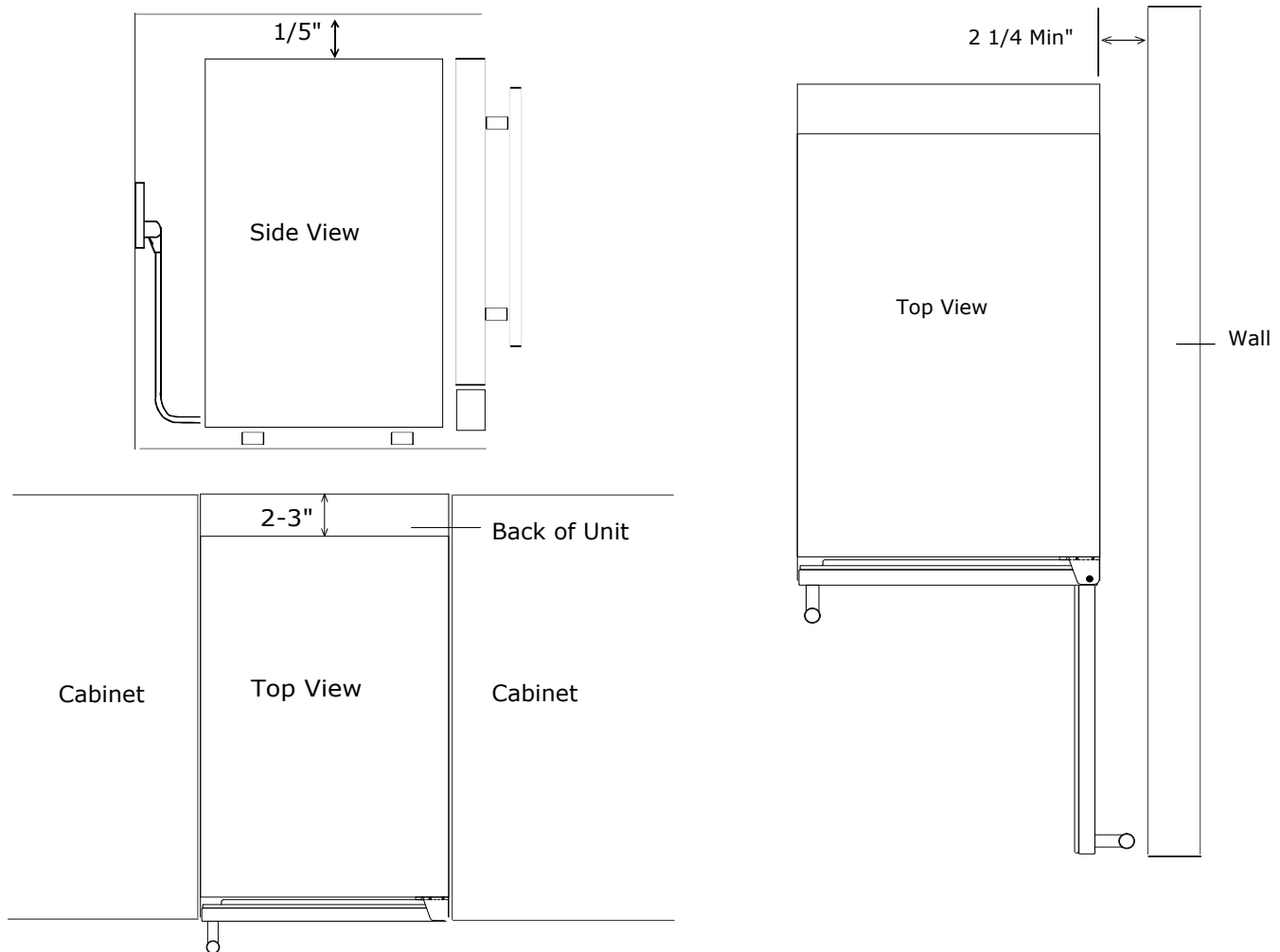

Units have a zero clearance for the door to open 90°, when installed adjacent to cabinets.

## Product Dimensions

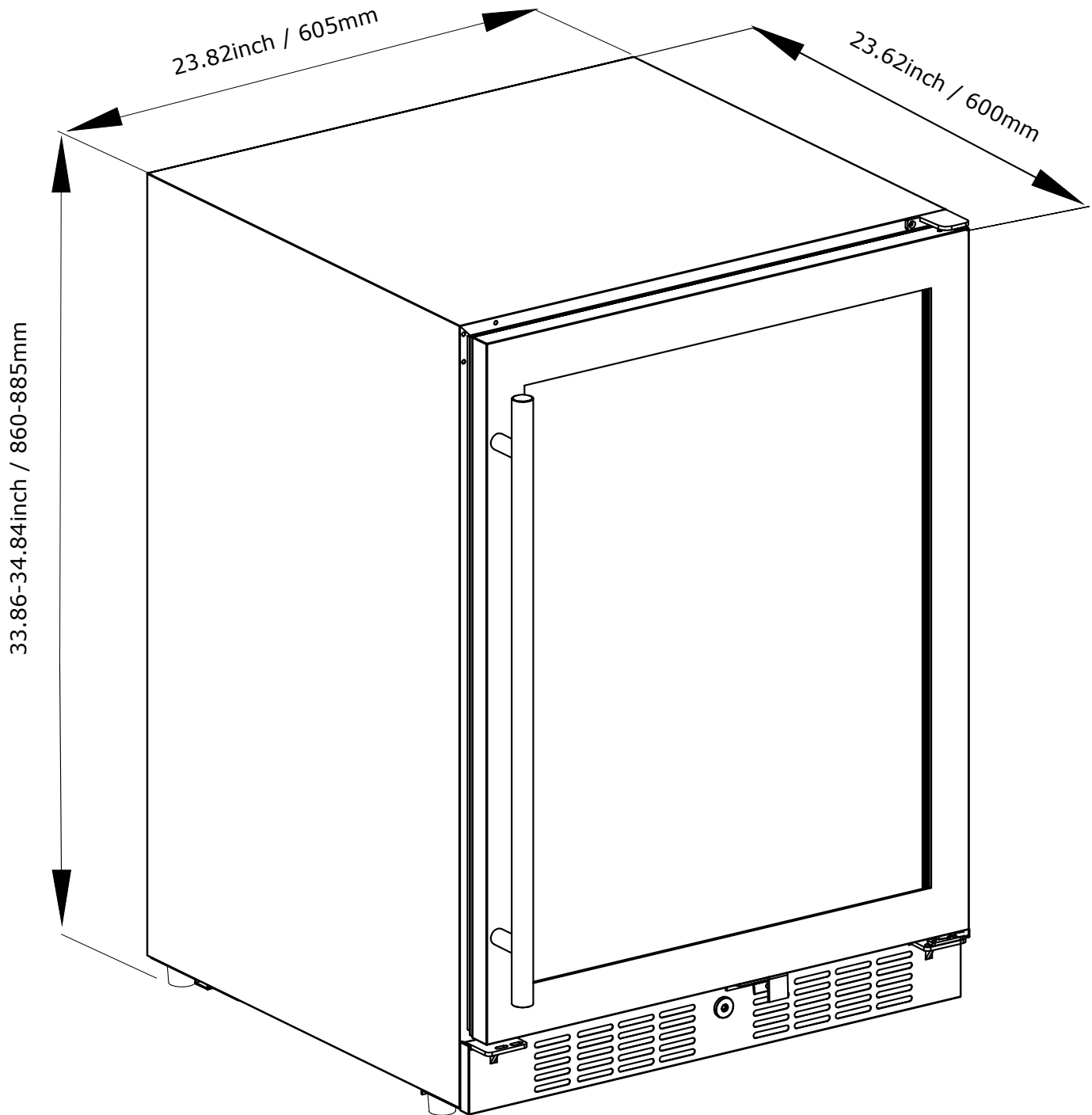

## Storage Capacity

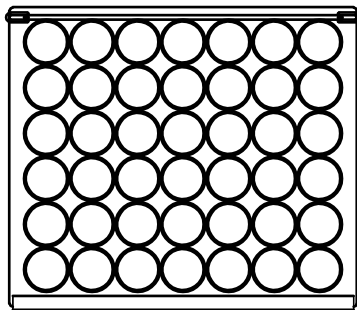
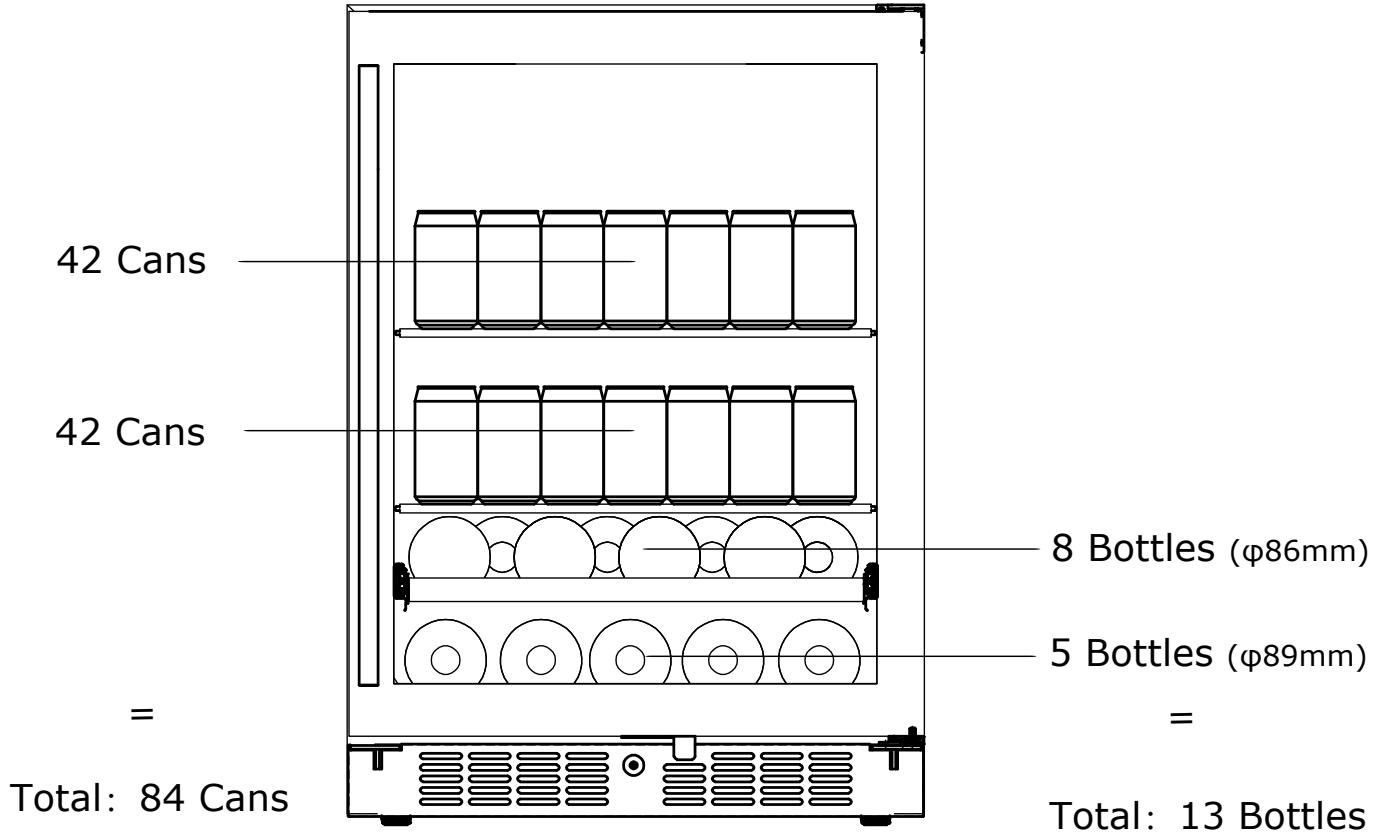

Glass Shelves (2)

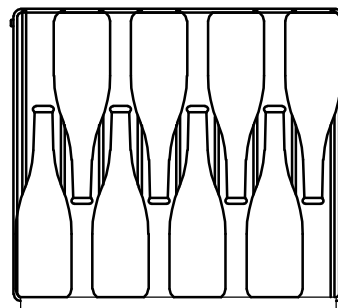
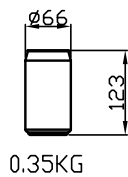

Wine Shelf (1)

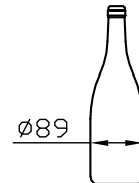
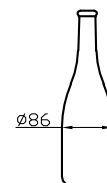

## Product Specification

DESCRIPTION OF PRODUCT	Single Zone Built-In Single Door Beverage and Wine Cooler
MODEL	TT-BW248413SZ
VOLTAGE / FREQUENCY	AC 115 / 60 Hz
AMPERAGE	1.5 A
COLOR	Black Cabinet with Stainless Steel Door
STORAGE CAPACITY	84 cans and 13 bottles
REFRIGERANT	R600a
TEMPERATURE RANGE	33° F to 72° F
DIMENSIONS W x H x D (in)	23.82" x 33.86-34.84" x 23.62"
NET WEIGHT (lbs)	115



Note: Technical data and performance information are provided for reference only. Specifications are subject to change. Check the rating label on the wine refrigerator for the most accurate information.

\*The storage capacity is based on standard 750 ml. wine bottles.

## **General Installation**

Before installation, please check and ensure that:

1. The appliance should be installed in accordance with local electrical code requirements.
2. The appliance should be placed in a location that is strong enough to support its total weight –always assume the weight when the appliance is fully loaded.
3. The appliance must be placed in its upright position for at least 24 hours before plugging in and powering on to allow the compressor’s oil to settle.

## **Unpacking the Appliance**

Before installation, please check and ensure that:

1. Always have two or more people to shift and install the unit to avoid back or other injuries.
2. Remove packaging materials carefully. Any shipping tape and glue from your appliance should be removed before using.
3. Never use sharp instruments, rubbing alcohol, flammable fluids, or abrasive cleaners when removing the tape or glue. These products can damage the surface of your appliance.

## **Appliance Feet Adjustment**

There is an adjustable leg on the bottom of the appliance that can be turned up or down to ensure that the appliance is level. It is important that the appliance is level to minimize noise and vibration.

1. Move the appliance to the designated location.
2. Turn the leveling leg counter-clockwise as far as it will go, until the top of the foot is touching the bottom of the chassis.
3. Slowly turn the leveling leg clockwise until the appliance is level.

### **IMPORTANT:**

Do not remove any safety, warning, or product information labels from your appliance.

## **Types of Installation:**

This appliance can be installed as a free standing or built-in unit. Keep in mind adequate ventilation and access for service is a must.

### 1. For free-standing installation:

- Allows the installation of the appliance in almost any place you desire.
- Please follow the stated instructions for electrical requirements, and leveling of the appliance.

### 2. For built-in installation:



- Allows the installation of the appliance under a counter or in a kitchen cabinet. Please ensure to provide the required clearance space around the appliance.
- Please make sure to allow adequate ventilation space around and in the back of the unit.
- Place the appliance in front of the installation location. Adjust the feet and place the unit flat on the floor or on a platform depending on your installation requirements.
- If the electrical outlet for the appliance is behind the cabinet, plug in the appliance.
- Push the appliance into position.
- Do NOT install the unit behind a closed cabinet door.

## **Unit Installation Steps**

1. Plug in the power/electrical cord.
2. Gently push the unit into position. Be careful not to entangle the cord.
3. Re-check the leveling, from front to back and side to side. Make any necessary adjustments. The unit's top surface should be approximately 1/5" below the countertop.
4. Remove the interior packing material and wipe out the inside of the unit with a clean, water-dampened cloth.
5. To prevent damaging the door or door gasket, make sure the door is open at least 90-degrees when pulling shelves out of the rail compartment.
6. The door opens to a maximum of 135 degrees with a door stop on the bottom hinge preventing the door from opening further.

## Attentions:

**Titan Products recommends allowing the unit to run overnight before loading with product. As warm air rises, the temperature inside the unit tends to be slightly warmer at the top and slightly cooler at the bottom.**

When plugged in, the unit will begin operating under the factory default settings. If the unit was turned off during installation, simply press  and the unit will immediately switch on. To turn the unit off, press  again.

## Handle Installation

Open the door, carefully pull the door gasket around the area where the handle is to be installed, and remove the two pre-installed decorative plugs from the front of the door. (Note: some models do not have decorative plugs installed.)

Insert the Phillips head screws through the gasket side of the door and pass through the door.

Align the handle with the screws and hand-tighten use screwdriver until the handle is flush against the door frame. (CAUTION: Do not over-tighten the screws as this may cause damage to the handle or to the stainless-steel door.)

Carefully press the door gasket back into its original position.



**Improper gasket installation will result in condensation**



## Wire Shelf Removal

1. Open the door completely.
2. Remove all of the contents loaded on the shelf, if applicable.
3. Line up the shelf notches with the rail posts as indicated below. This will require you to hold on to both rails as you move the shelf to line up the posts with the notches on both sides of the shelf.
4. Evenly lift the shelf up and then pull the shelf out.

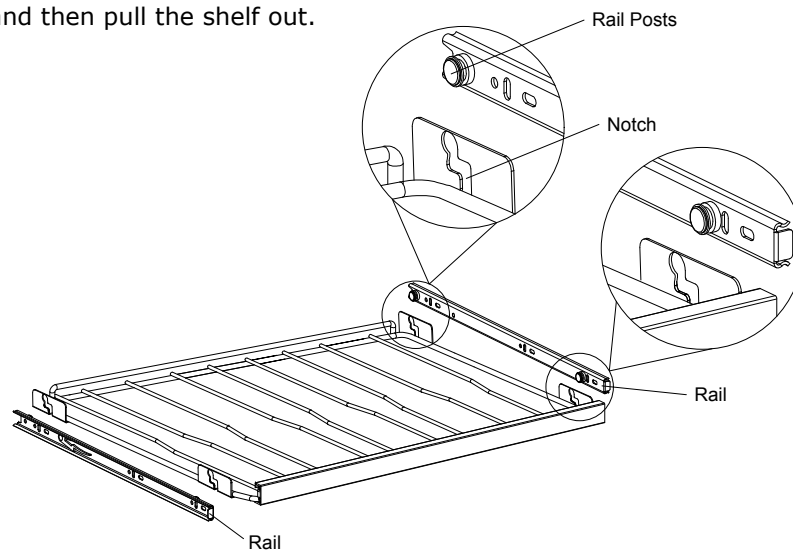

## Glass Shelf Removal

1. Open the door completely- make sure to open the door all the way before pulling the shelves out of their track to prevent damaging the door gasket.
2. Remove all contents sitting on the shelf, if any.
3. Tilt one side of the shelf up at a 45-degree angle.
4. Then proceed to pull out the shelf slowly.

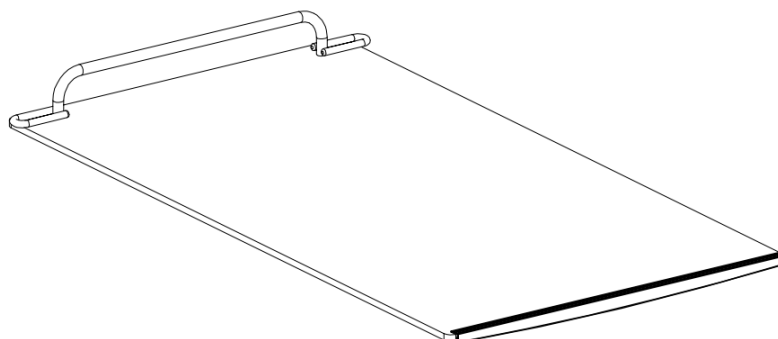

## Operation Instruction







### Check before operation

- Have you removed all packing materials and tape from the interior and exterior of the unit?
- Have you installed the unit properly by following the installation instructions?
- Has the unit been properly connected to the electrical outlet including proper grounding?
- Have you leveled the unit?
- Is the appliance properly located in an area where the ambient temperature is between 50°F and 95°F all year round?
- Is the clearance of the unit at least 2 to 3 inches at the rear provided for proper air circulation?

### Control Operation



This wine cooler has a temperature range for temperature zone from 33°F to 72°F (or 0°C to 22°C)

FUNCTION	COMMAND	DISPLAY/OPTIONS
ON/OFF	 Press and hold for 3 seconds	Unit will immediately turn ON or OFF.
Energy Saving	 Press to turn this mode ON/OFF	When this mode is turned on, the LED light and display will be turned off .
Up	 Press and release	Temperature will increase by 1 °F o r 1 °C
Down	 Press and release	Temperature will decrease by 1 °F o r 1 °C
Interior Light	 Press and release	The interior light will cycle between three colors
LED Display		Displays the set temperature
Indicator Light		Indicate that compressor is operating
Toggle between °F/°C	Press and hold the Up and Down buttons at the same time for 2 seconds and release	The temperature display will change between °F and °C

## **Power Button**

Press and hold this button down for three seconds to power your unit on. Once pressed, the "Indicator Light" will illuminate to indicate the unit is on and running. Press and hold this button for three seconds again and the unit will power off and the "Indicator Light" will turn off.

## **Up Button**

Press this button to increase the setting temperature by one (1) degree increments.

## **Lower Zone Temperature**

Press this button to decrease the setting temperature by one (1) degree increments.

## **Interior Light**

Press this button to cycle between three internal light colors.

This refrigerator is equipped with top internal lights, Deep Blue, Cloud White or Amber, illuminating the interior to be seen through the glass door. You can choose to display each color of light in two different modes: Display Mode and Automatic Mode.

### **\* Display Mode**

The internal lights will stay constantly illuminated whether the door is open or closed. Display Mode is a custom/user-defined function, not a regular day to day function

### **\* Automatic Mode**

The internal lights will illuminate each time the door is opened and fade off once the door is closed. This feature is triggered by a sensor located on the front vent. This sensor allows the refrigerator to recognize when the door is open or closed.



\*The default mode is Automatic Mode. To change between modes, press and hold the Interior Light button  for 3 seconds.

We run test every unit that we produce in our factory. Because of this, your model may default to any of the above settings out of the box. Simply cycle through the progression of settings until you reach your desired setting.



Tip: Close the door to determine if the light is currently in Display Mode or Automatic Mode. In Display Mode the lights will remain on, and in Automatic Mode the lights will fade off once the door is closed.

## **Sabbath Mode**

Sabbath mode disables system responses to user-initiated activities and all external functions, including lighting, display and audible alarms. The unit will maintain internal temperatures and set points.

To enable or disable Sabbath mode, Press the Energy Saving button . The interior light and control display will go dark until the user disables Sabbath mode.

Although the display will not be visible, the temperature settings will remain active and preserve the internal temperature. Sabbath mode will remain active until it is disabled by the user.

## **Temperature Memory**

This appliance has a temperature memory function. The temperature setting is automatically saved. In case of a power outage, the temperature setting will remain when power resumes.

## **Temperature Alarm**

When the unit's interior temperature is higher than 81°F (27°C), "HI" will display on the panel and a buzzing alarm sound will go off. When the interior temperature is lower than 23°F (-5°C), "LO" will display on the panel, the alarm and the malfunction indicator light will go off at the same time. In either case, immediate attention is advised.

## **Door Alarm**

This unit is equipped with an audible alarm to alert you when the door has been left open.

If at any time the door has been left open for more than 3 minutes, the alarm will sound and will continue to sound until the door is closed completely or the unit is powered off.

 **WARNING**

Allow at least 24 hours for your wine cooler to run before storing your beverages to allow the temperature to acclimate. Whether your wine cooler can reach the actual set temperature depends on the ambient environmental condition

 **CAUTION**

1. If you powered the unit off, please wait at least five (5) minutes before powering it back on.
2. The ambient environmental conditions determine whether your unit can reach the actual set temperature.
3. There is a temperature allowance of +/- 2 degrees Celsius.
4. The unit requires proper airflow to perform at its highest efficiency. Do not block the front grille, or the unit will not perform as expected. Do not install the unit behind a door. When loading your unit, leave space between the evaporator and product loaded. Anything in direct contact with the evaporator is subject to freezing.

## Sounds

Some sounds and noises generated by this appliance may not be common to you, however most of these sounds are normal. Hard surfaces like floor and walls may make the sounds seem louder than they actually are.

The following are the sounds you may be experiencing and what's making them.

- Rattling sounds – These may come from the flow of the refrigerant or the water line. Make sure nothing is stored on top of the appliance as this may damage the appliance and also create rattling sounds.
- High-pitched sound – These may come from the efficient compressor.
- Splashing sound – Water running from the evaporator to the water bin.
- Gurgling sound -- May be generated due to the refrigerant flowing in the unit.
- Fan noise – From the condenser fan circulate air within the unit.

## Defrosting

The unit automatically defrosts under most ambient conditions and refrigerating settings. However some frost may build up under colder settings.

Additionally, frost may also build up under more humid ambient conditions. Keep the door closed as much as possible and avoid opening the door unnecessarily to minimize frost build-up.

If frost prevents the door from closing properly, power the unit off until the frost melts. Use a soft absorbent towel to dry the unit.

### WARNING:

NEVER attempt to remove frost with sharp objects. This may damage the appliance.

## Maintenance

### Cleaning

#### Exterior Cleaning

##### Vinyl Clad (Black)

Clean surfaces with a mild detergent and warm water solution. Do not use solvent-based or abrasive cleaners. Use a soft sponge and rinse with clean water. Wipe with a soft, clean towel to prevent water spotting.

Clean any glass surfaces with a non-chlorine glass cleaner.

##### Stainless Models

Stainless door panels, handles and frames can discolor when exposed to chlorine gas, pool chemicals, saltwater or cleaners with bleach.

Keep your stainless unit looking new by cleaning with a good quality all-in-one stainless steel cleaner and polish monthly. For best results use Claire® Stainless Steel Polish and Cleaner. Comparable products are also acceptable. Frequent cleaning will remove surface contamination that could lead to rust. Some installations may require cleaning weekly.

**Do not clean with steel wool pads.**

**Do not use stainless steel cleaners polishes on any glass surfaces.**

Clean any glass surfaces with a non-chlorine glass cleaner.

**Do not use cleaners not specifically intended for stainless steel on stainless surfaces (this includes glass, tile and counter cleaners.**

If any surface discoloring or rusting appears, clean it quickly with Bon-Ami® or Barkeepers Friend Cleanser® and a nonabrasive cloth. Always clean with the grain. Always finish with Claire® Stainless Steel Polish and Cleaner or comparable product to prevent further problems.

**Using abrasive pads such as Scotchbrite™ will cause the graining in the stainless steel to become blurred.**

**Rust not cleaned up promptly can penetrate the surface of the stainless steel and complete removal of the rust may not be possible.**

#### Integrated Models

To clean integrated panels, use household cleaner per the cabinet manufacturer's recommendation.

### INTERIOR CLEANING

Disconnect power to the unit.

Clean the interior and all removed components using a mild nonabrasive detergent and warm water solution applied with a soft sponge or non-abrasive cloth.

Rinse the interior using a soft sponge and clean water.

Do not use any solvent-based or abrasive cleaners. These types of cleaners may transfer taste to the interior products and damage or discolor the interior.

 **Warning**

**DO NOT use an ice pick or other sharp instrument to help speed up defrosting. These instruments can puncture the inner lining or damage the cooling unit. DO NOT use any type of heater to defrost. Using a heater to speed up defrosting can cause personal injury and damage to the inner lining.**

**NOTICE**

**The draining pan was not designed to capture the water created when manually defrosting. To prevent water from overflowing the drain pan, place towels or other absorbent materials over the interior drain trough (under the evaporator) before defrosting.**



## Troubleshooting

PROBLEM	POSSIBLE CAUSE
Appliance does not operate	<ul style="list-style-type: none"> <li>• Not plugged in.</li> <li>• The appliance is turned off.</li> <li>• Tripped circuit breaker or blown fuse.</li> </ul>
Appliance is not cold enough	<ul style="list-style-type: none"> <li>• Check the temperature control setting.</li> <li>• External environment may require a higher setting.</li> <li>• The door is opened too often.</li> <li>• The door is not closed completely.</li> <li>• The door gasket does not seal properly.</li> </ul>
Turns on and off frequently	<ul style="list-style-type: none"> <li>• The room temperature is higher than normal.</li> <li>• A large amount of contents has been added to the appliance.</li> <li>• The door is opened too often.</li> <li>• The door is not closed completely.</li> <li>• The temperature control is not set correctly.</li> <li>• The door gasket does not seal properly.</li> </ul>
The light does not work	<ul style="list-style-type: none"> <li>• Not plugged in.</li> <li>• Tripped circuit breaker or blown fuse.</li> <li>• The bulb has burned out.</li> </ul>
Vibrations	<ul style="list-style-type: none"> <li>• Check to be sure the appliance is level.</li> </ul>
The appliance seems to make too much noise	<ul style="list-style-type: none"> <li>• The rattling noise may come from the flow of the refrigerant, which is normal. As each cycle ends, you may hear gurgling sounds caused by the flow of refrigerant in your appliance. Contraction and expansion of the inside walls may cause popping and crackling noises.</li> <li>• The appliance is not level.</li> </ul>
The door will not close properly	<ul style="list-style-type: none"> <li>• The appliance is not level.</li> <li>• The door was reversed and not properly re-installed.</li> <li>• The gasket is dirty.</li> <li>• The shelves are out of position.</li> </ul>

## Titan Products, LLC Limited Warranty

### THIS WARRANTY COVERS:

- The original purchaser within all states in the continental United States (excluding Hawaii and Alaska) for one year from the date of purchase against defects in materials and workmanship under normal use and service.
- Titan will be responsible for all transportation costs incurred in the event that service under this warranty is needed for the first 3 months from original purchase date. Consumer will be responsible for freight cost to Titan's service department after 3 months to one year.
- Titan will repair or replace any parts found defective with new, rebuilt, or refurbished parts free of charge.
- Titan reserves the right to request a defective part be returned in exchange for the replacement part.
- After the one year limited warranty, any labor charges or replacement parts will be the responsibility of the original owner of the unit.
- This warranty is not transferable.

### THIS WARRANTY DOES NOT COVER:

- Shipping damage and any damage caused by improper packaging for shipment to Titan.
- Cosmetic damage such as scratches and dents or other appearance parts by wear and tear.
- Damage not caused by a defect in material or workmanship while in the possession of a consumer.
- Damage caused by consumer misuse, abuse, tampering, or failure to follow the care and special handling instructions provided in the owner's manual.
- Damage caused by improper installation, maintenance negligence, commercial use, repairs or alterations to the product by anyone not authorized by the manufacturer.
- Acts of God, such as fire, flood, hurricanes, earthquakes and tornadoes.
- Products sold AS Is or from an unauthorized seller.
- Freight and Insurance cost for the warranty service.

### Obtaining Warranty Service:

Contact Titan Customer Service at [service@titan-appliances.com](mailto:service@titan-appliances.com) for troubleshooting, assistance and warranty service. You are required to have your model number, serial number and proof of purchase before contacting Customer Service. Once a Titan Customer Service Representative has confirmed that your product is eligible for warranty service, the product must be returned to an authorized repair center. The returned product must be packaged carefully in its original packaging with the original box and packaging material to avoid shipping damages. Titan is not responsible for damage resulting from mishandling or improper packaging. Do not return a defective product to the place of purchase.

Products received without a return authorization number will be refused.

### **DISCLAIMER OF IMPLIED WARRANTIES; LIMITATION OF REMEDIES**

*CUSTOMER'S SOLE AND EXCLUSIVE REMEDY UNDER THIS LIMITED WARRANTY SHALL BE PRODUCT REPAIR OR REPLACEMENT AS PROVIDED HEREIN. IMPLIED WARRANTIES INCLUDING WARRANTIES OF MERCHANTABILITY OR FITNESS FOR A PARTICULAR PURPOSE, ARE LIMITED TO ONE YEAR. WARRANTOR SHALL NOT BE LIABLE FOR CONSEQUENTIAL OR INCIDENTAL DAMAGES SUCH AS PROPERTY DAMAGE AND INCIDENTAL EXPENSES RESULTING FROM ANY BREACH OF THIS WRITTEN LIMITED WARRANTY OR ANY IMPLIED WARRANTY. SOME STATES AND PROVINCES DO NOT ALLOW THE EXCLUSION OR LIMITATION OF INCIDENTAL OR CONSEQUENTIAL DAMAGES, OR LIMITATIONS ON THE DURATION OF IMPLIED WARRANTIES, SO THESE LIMITATIONS OR EXCLUSIONS MAY NOT APPLY TO YOU. THIS WRITTEN WARRANTY GIVES YOU SPECIFIC LEGAL RIGHTS. YOU MAY ALSO HAVE OTHER RIGHTS THAT VARY FROM STATE TO STATE.*