

I N S T R U C T I O N S

IMPORTANT: In order to make the whole product adjust to the best, please install all the screws on the product before fully tighten, and note to put the washer to the screw before putting the screw into the screw hole.

Please follow the instructions below to ensure that the furniture is stable and firm.

Three- seat sofa

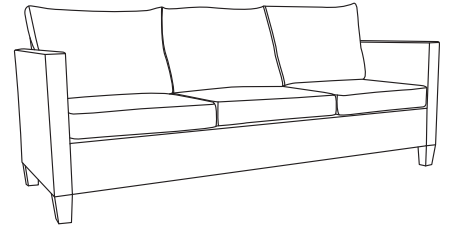

| | | | | | | | | | | | |
|----------|----------|----------|----------|----------|----------|----------|----------|----------|----------|----------|----------|
| | | | | | | | | | | | |
| A | B | C | D | E | K | F | G | H | I | J | L |
| 1pc | 1pc | 1pc | 1pc | 3PCs | 4PCs | 4PCs | 4PCs | 1pc | 1pc | 2PCs | 2PCs |

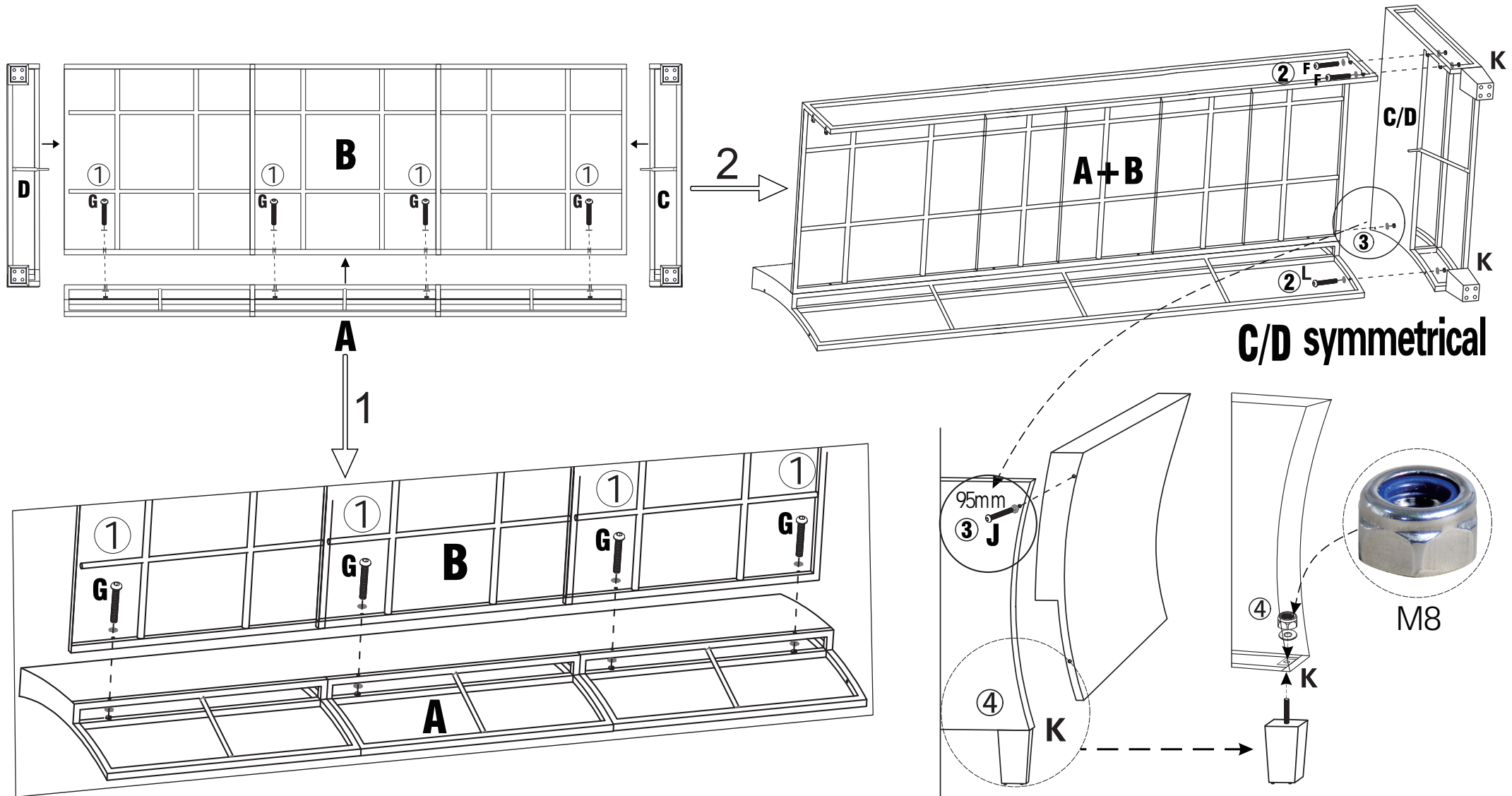

INSTRUCTIONS

IMPORTANT: In order to make the whole product adjust to the best, please install all the screws on the product before fully tighten, and note to put the washer to the screw before putting the screw into the screw hole.

Please follow the instructions below to ensure that the furniture is stable and firm.

Ottoman

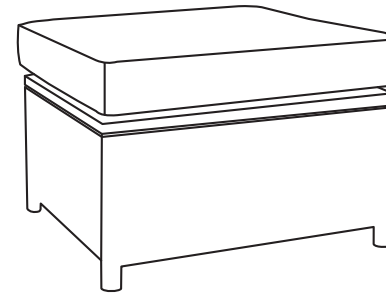

| | | | | | |
|----------|----------|----------|----------|----------|----------|
| | | | | | |
| A | B | C | D | E | F |
| 1pc | 2PCs | 2PCs | 1pc | 14PCs | 1pc |

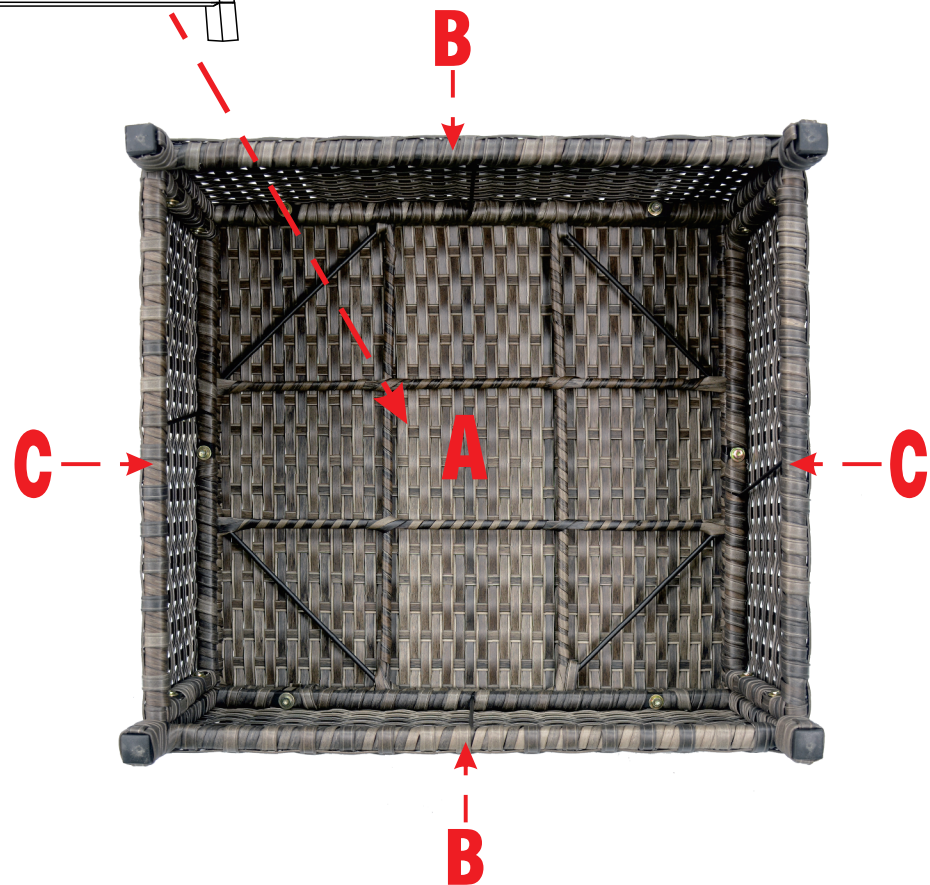
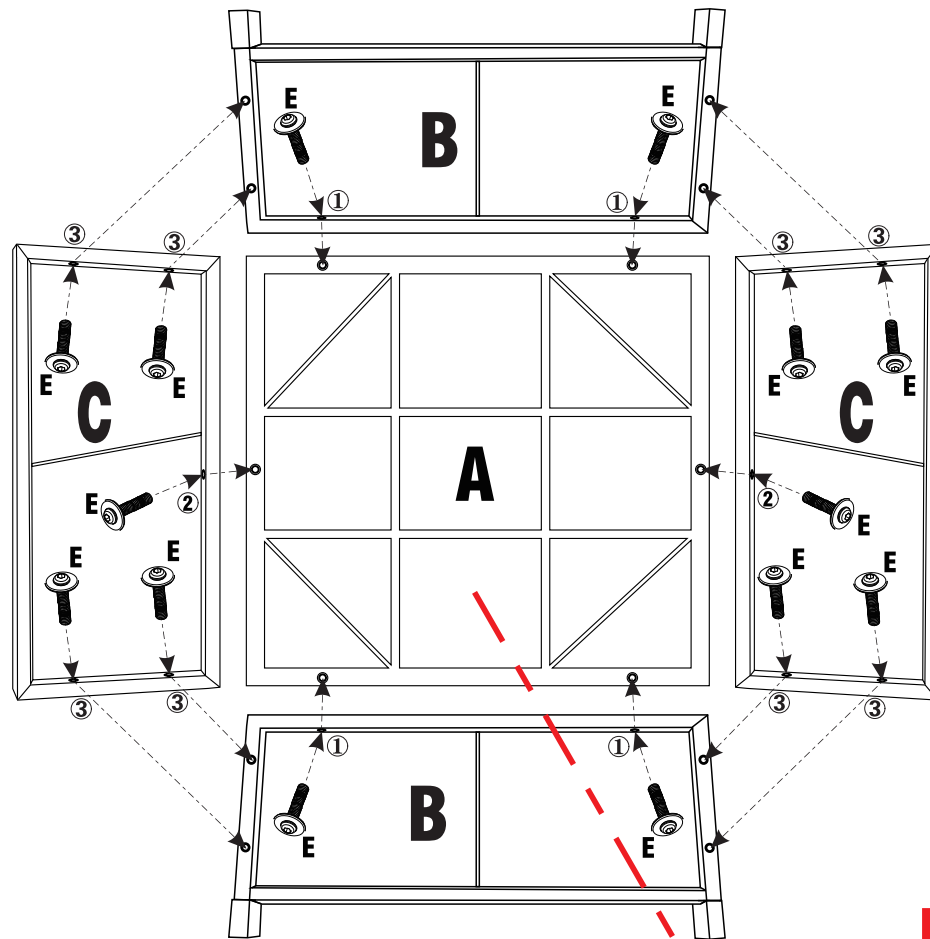

INSTRUCTIONS



Single sofa

IMPORTANT: In order to make the whole product adjust to the best, please install all the screws on the product before fully tighten, and note to put the washer to the screw before putting the screw into the screw hole.

Please follow the instructions below to ensure that the furniture is stable and firm.

| A | B | C | D | E | F | G | H | S | T | U |
|-------------|----------|----------|-----------|-----------------|-----------------|-----------------|--------------|------|--------|------------------|
| | | | | | | | | | | |
| 1PC | 1PC | 1PC | 1PC | M6*35mm 4PCS | M6*60mm 4PCS | M6*95mm 2PCS | 18PCS | 8PCS | 1PC | 1PC |
| CHAIR PLATE | BACKREST | LEFT LEG | RIGHT LEG | METAL SCREW | METAL SCREW | METAL SCREW | METAL WASHER | Nut | wrench | ALLEN KEY WRENCH |

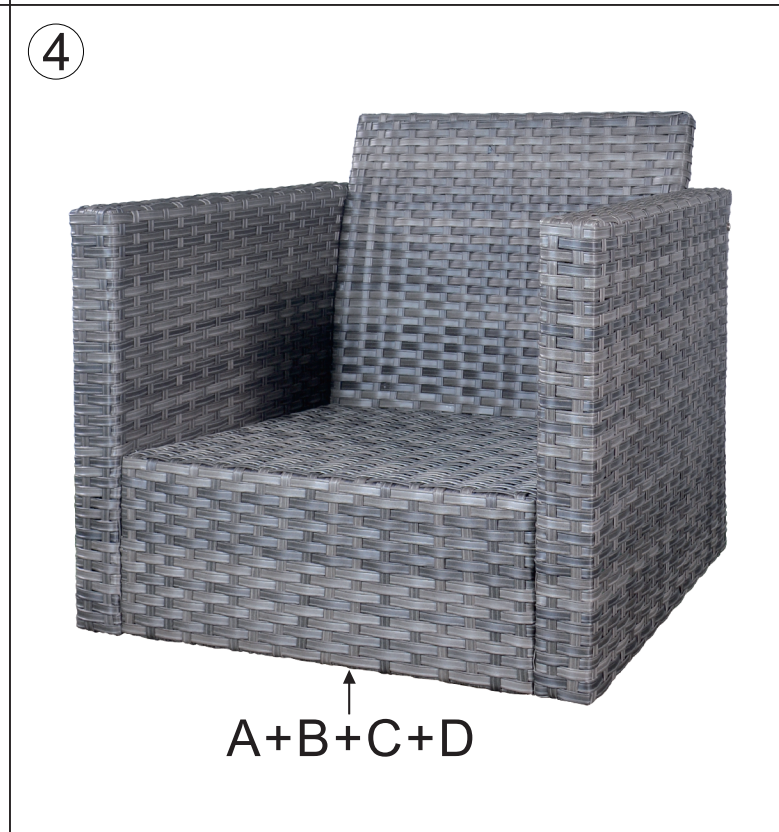
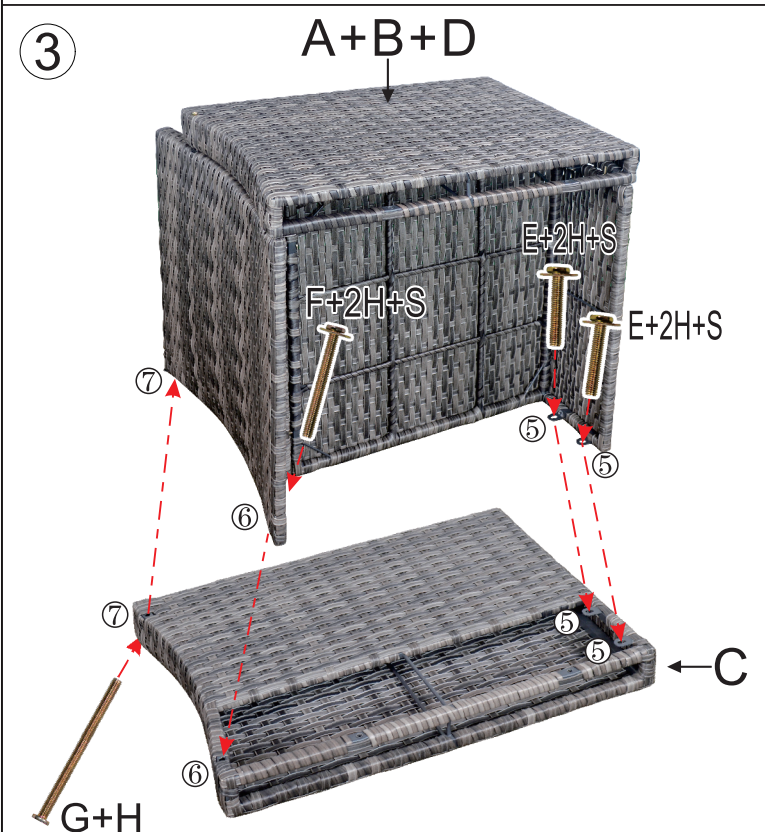
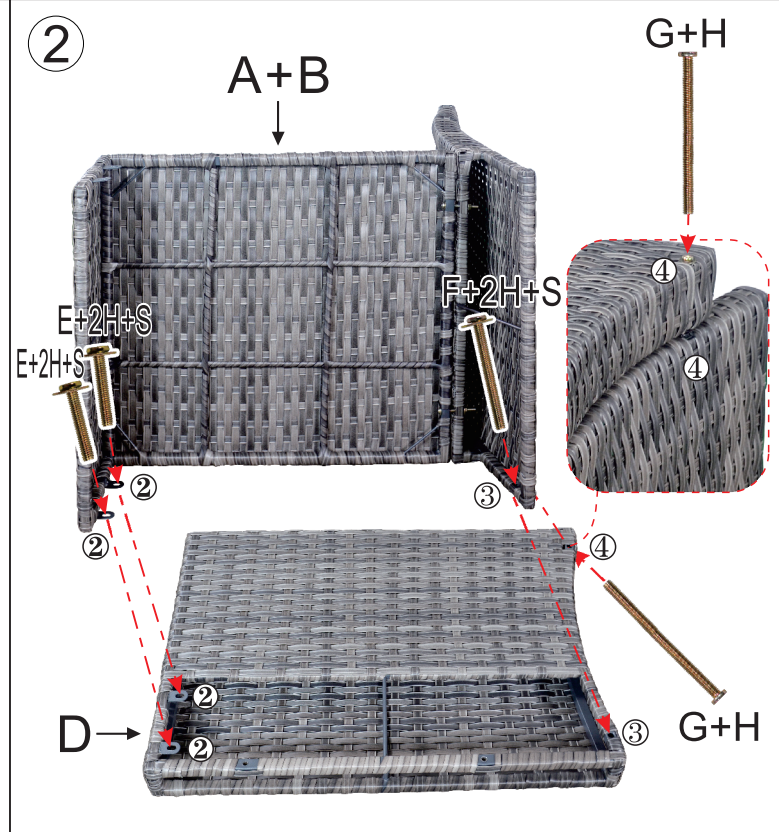
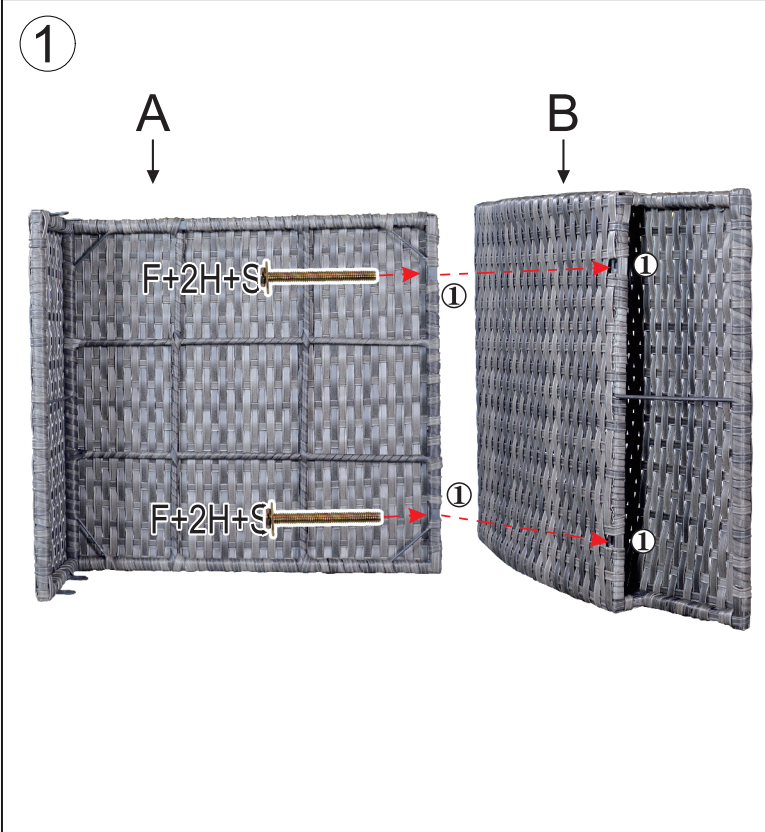

INSTRUCTIONS



swivel sofa

IMPORTANT: In order to make the whole product adjust to the best, please install all the screws on the product before fully tighten, and note to put the washer to the screw before putting the screw into the screw hole.

Please follow the instructions below to ensure that the furniture is stable and firm.

| I | J | K | L | M | N | O | P | Q | R |
|------|------|------|-------------------|-----------------|-----------------|------|------------------|--------|-----------------------|
| | | | | | | | | | |
| 1PCS | 1PCS | 1PCS | 16PCS | M6*35mm 4PCS | M6*40mm 4PCS | 8PCS | 1PCS | 1PCS | 1PCS |
| | | | METAL WASHER (m6) | METAL SCREW | METAL SCREW | Nut | ALLEN KEY WRENCH | wrench | SEAT AND BACK CUSHION |

①

M+O+2L

Metal washer+Nut

I+J

②

Notice:

N+O+2L

Metal washer



Nut

I+J+K

INSTRUCTIONS

IMPORTANT:In order to make the whole product adjust to the best,please install all the screws on the product before fully tighten,and note to put the washer to the screw before putting the screw into the screw hole.

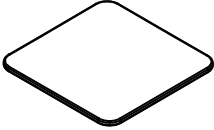
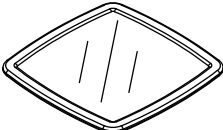
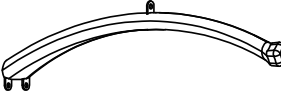
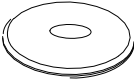
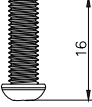
Please follow the instructions below to ensure that the furniture is stable and firm.

| A | B | C | D | E | F |
|---|--|---|---|---|--|
|  1PC |  1PC |  4PCS |  12PCS |  M6*16mm 12PCS |  1PC |
| LEG CONNECTION FRAME | TABLE TOP | LEG | METAL WASHER(m6) | METAL SCREW | ALLEN KEY WRENCH |

