

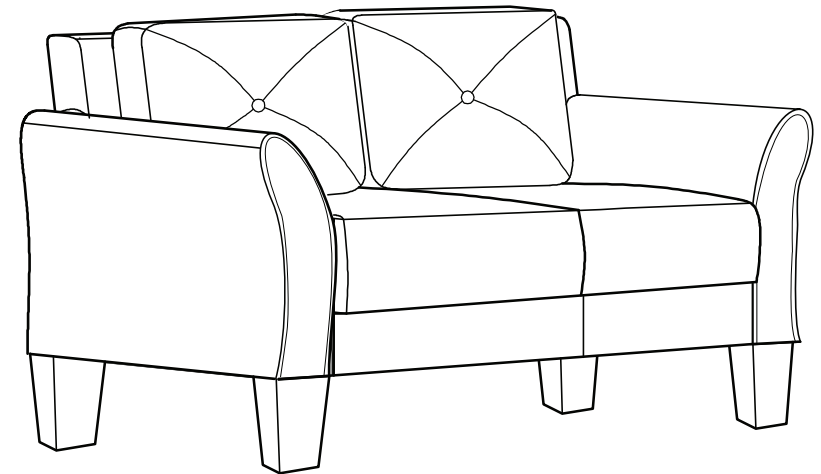

LIFESTYLE
S O L U T I O N S



HARTFORD WITH CURVE ARM LOVESEAT
ASSEMBLY INSTRUCTIONS

PARTS AND HARDWARE

Avoid using sharp objects such as a knife to open packing as you may accidentally damage the upholstery.

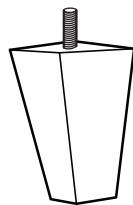

Leg
4x



M10 Washer
(Outer Dim. 45mm)
4x

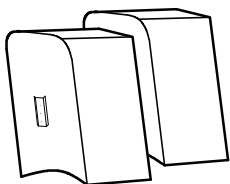

Backrest Ear Piece
2x

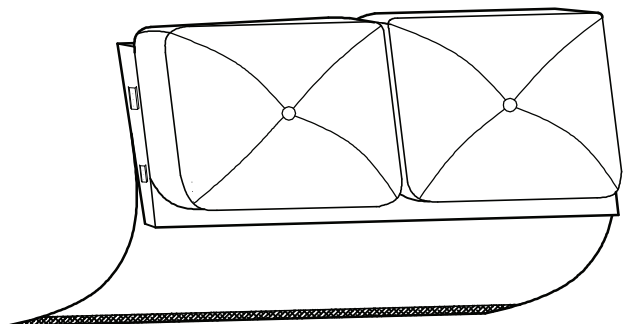

Backrest
1x

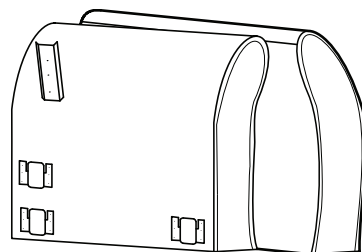

Arm
1 Pair

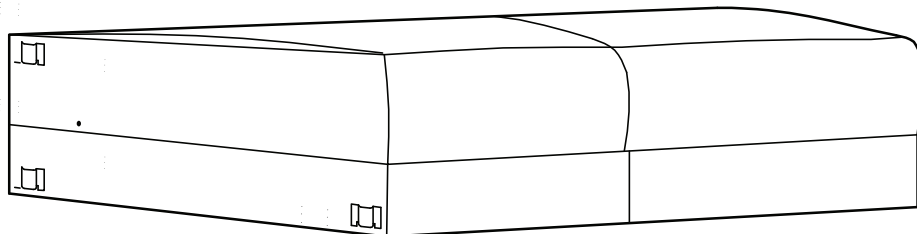

Seat Body
1x

ASSEMBLY INSTRUCTIONS

CAUTION: At least two adults are required to safely complete performing this task.
Other lifting attempts may risk back injury due to large and heavy part(s).



- 1** Carefully unpack parts/hardware from storage of seat body and place on a clean flat surface.

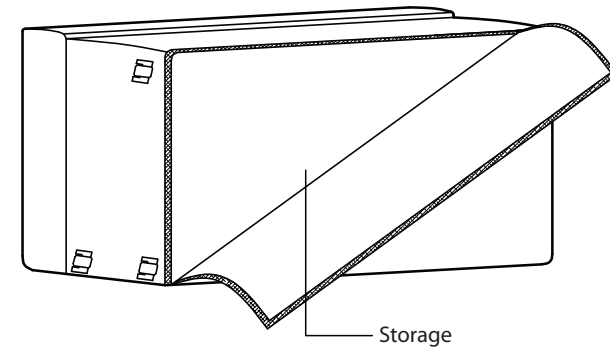

- 2** Place both arms as shown below, secure two legs and plastic washers into pre-drilled holes on the bottom of arms. Please avoid overtightening.

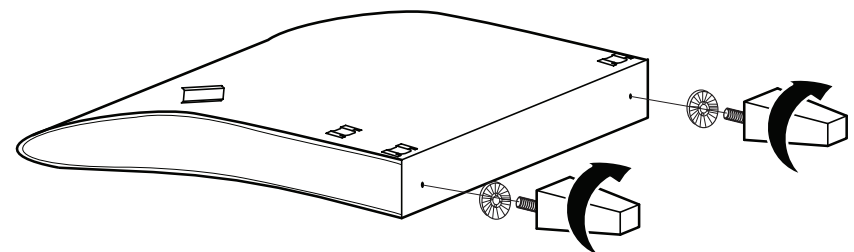

- 3** Carefully lift and turn assembled arms onto its legs. Insert seat body metal plates to both arms as shown below. Ensure it is correctly in place.

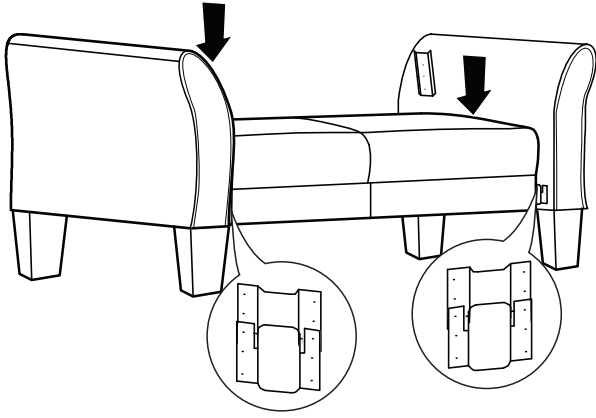

- 4** Insert both backrest ear piece metal plates to both sides of backrest. Ensure it is correctly in place.

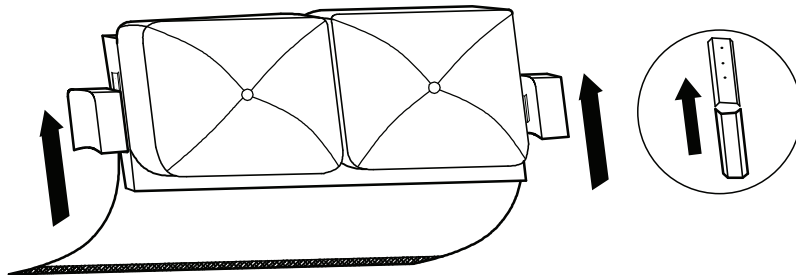

- 5** Insert backrest with ear piece metal plates to both arms as shown below. Ensuring it is correctly in place.

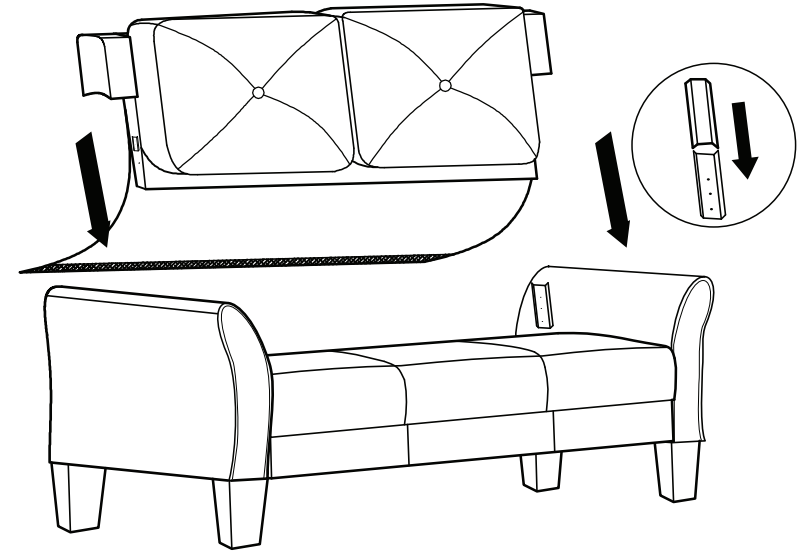

- 6** Finally, stretch and pull down rear cover evenly before securing velcro strip to seat base. Repeat if necessary for better fit.

