

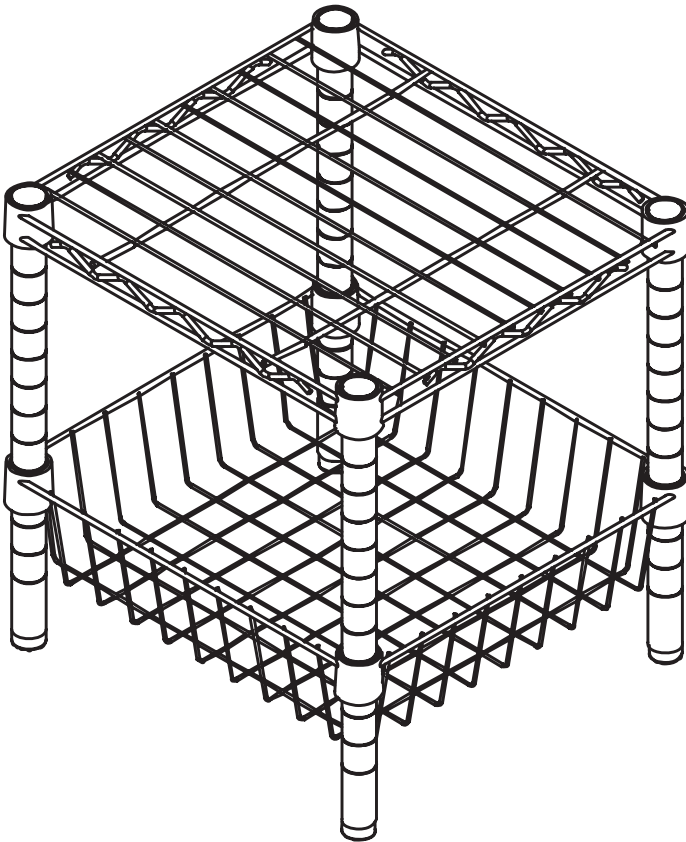

SHF-01503
SHF-02216

modular stacking urban table with basket



14 in L x 15 in W x 16 in H (35.6 cm L x 38.1 cm W x 40.6 cm H)

PARTS LIST

PART/ILLUSTRATION

(QTY)

DESCRIPTION

A

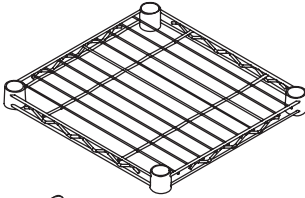

(1) **shelf**

B

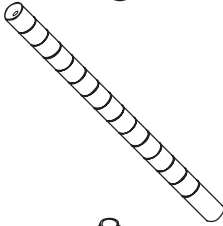

(4) **support poles**

C

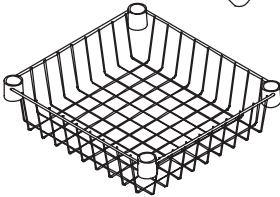

(1) **basket**

D



(16) **shelf support clips**
(8 pairs)

E

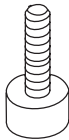

(4) **leveler feet**
(comes preassembled on some models)

F



(4) **post caps**

G



(4) **stacking pins**
(for stacking multiple units)

ASSEMBLY

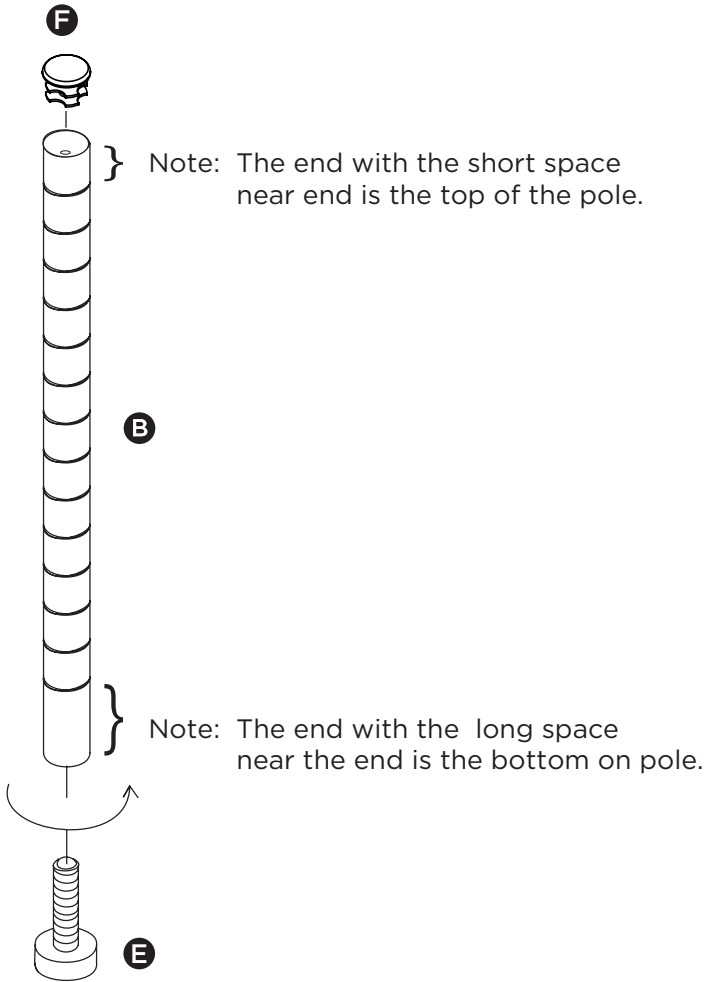

1. **Begin by identifying the top and bottom of each pole (B) see illustration above.**
2. **Next insert the 4 top caps (F) into the top each of the 4 poles (B).**
3. **Screw the leveler feet (E) into the bottom of each pole (B).**
(comes preassembled on some models) You will use these adjustable feet to help level your item on uneven surfaces.

ASSEMBLY

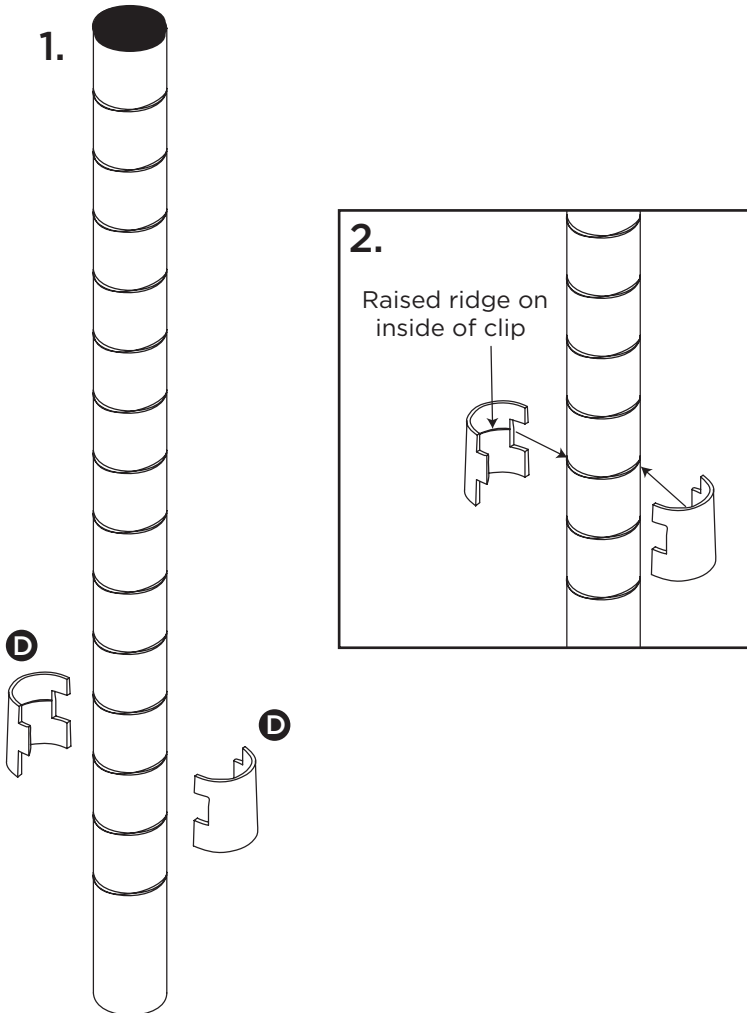

1. The shelf (A) and basket (C) are held on with pairs of the shelf support clips (D). Align two halves of the shelf support clips (D) on the support pole (B) at the desired height of the basket.
2. The shelf support clip (D) is in the proper place when the raised ridge on the inside of the clip locks into the depressed ridge on the support pole (B). Repeat for all 4 support poles so all clips are at the same height.

ASSEMBLY

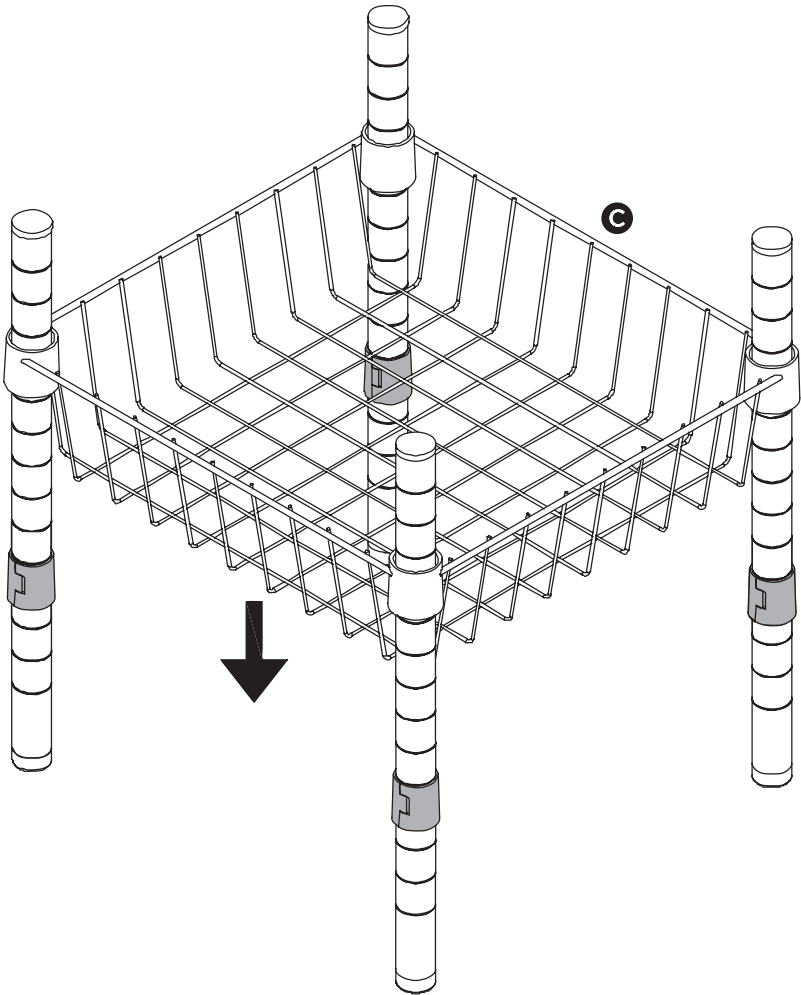

1. Slide basket (C) down over all four support poles (B).
2. Confirm that shelf support clips (D) are at the same height on each support pole (B) and are locked into place.
3. Push basket firmly down.

ASSEMBLY

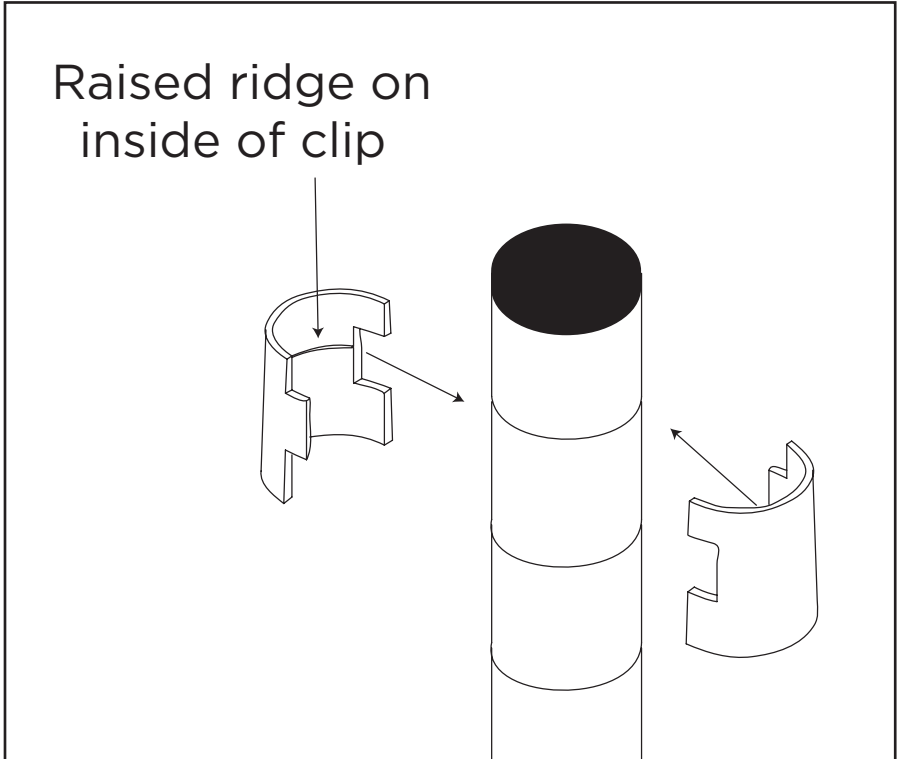

1. Repeat steps from page 4. Locate clips at desired height for top shelf (A).

ASSEMBLY

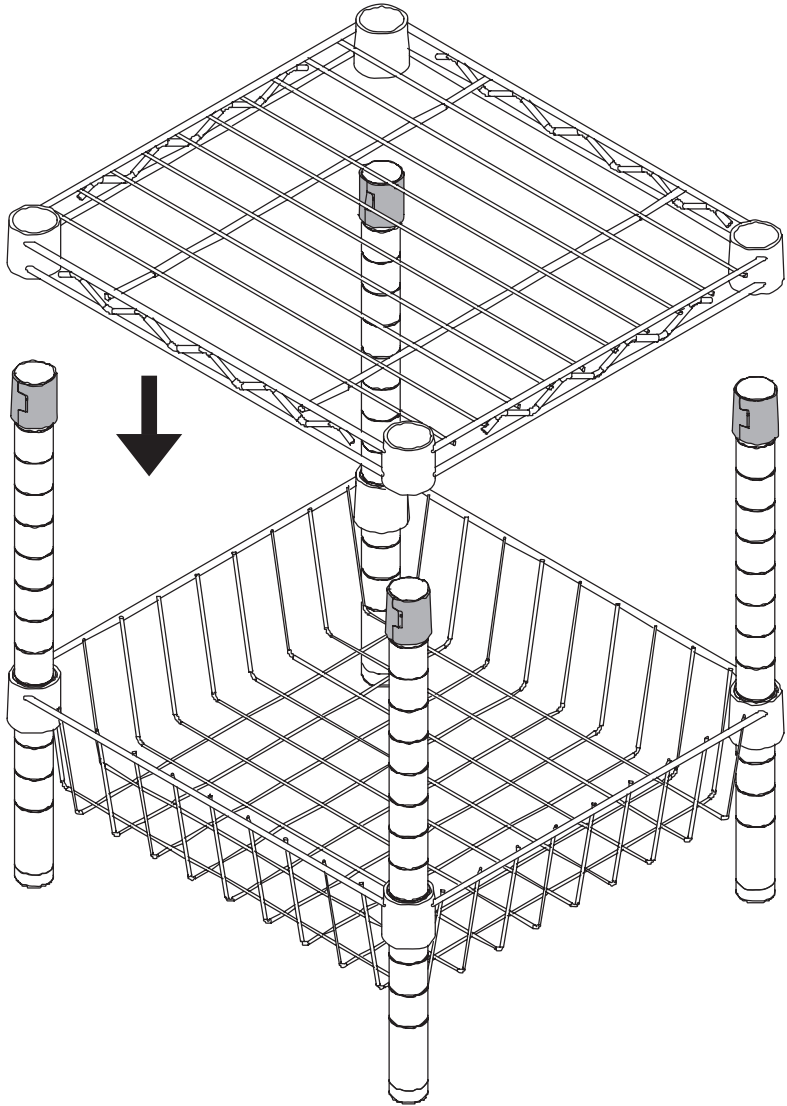

1. Slide top shelf (A) onto four support poles and push firmly into place.

****Warning: Steel shelving units should not be overloaded and heaviest items should be stored on the bottom shelf. DO NOT stand or climb on shelving units. If children are present and/or shelving units are stacked they should be secured to a wall to prevent tipping and injury.**

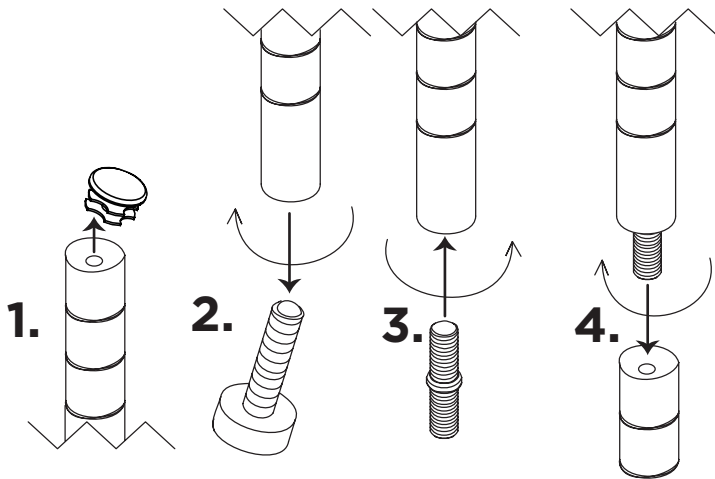

stacking additional unit

1. Remove the post cap(E) of lower unit.
2. Remove lever foot(F) of upper unit. *(Do not add shelves to upper unit until you have completed the following steps).*
3. Screw stacking pins(G) into bottom of upper unit support poles.
4. Screw upper support poles onto stacking pins.
5. Add shelves to upper unit.

LIMITED LIFETIME WARRANTY

Honey-Can-Do International, LLC (HCD) warrants its products will be free from defects in materials and workmanship when used for normal personal or household use, except as provided below. HCD, at its option, may offer a comparable product or offer a replacement part or request that the item be returned to the place of purchase. This warranty DOES NOT apply to damage caused by negligence, misuse, excessive use, improper cleaning, improper assembly, or any circumstances not directly attributable to manufacturing defects. Proof of purchase is required in the form of a receipt (copy or original) to validate warranty. HCD provides this limited lifetime warranty in lieu of all other warranties either express or implied. In no event shall HCD, its affiliates, or subsidiaries be responsible for consequential or incidental damages arising out of a claim of defective product. Some states or provinces do not allow some exclusions or limitations, so the above statement may not apply to you. This warranty gives you specific legal rights, and you may also have other rights, which vary by state or province.

WARNING: Keep bags and plastic sheeting away from babies and children. Do not use in cribs, beds, carriages, or playpens. The plastic may cling to nose and mouth and prevent breathing.



YOUR SOURCE FOR
ORGANIZATION,
STORAGE & STYLE