

PARTS

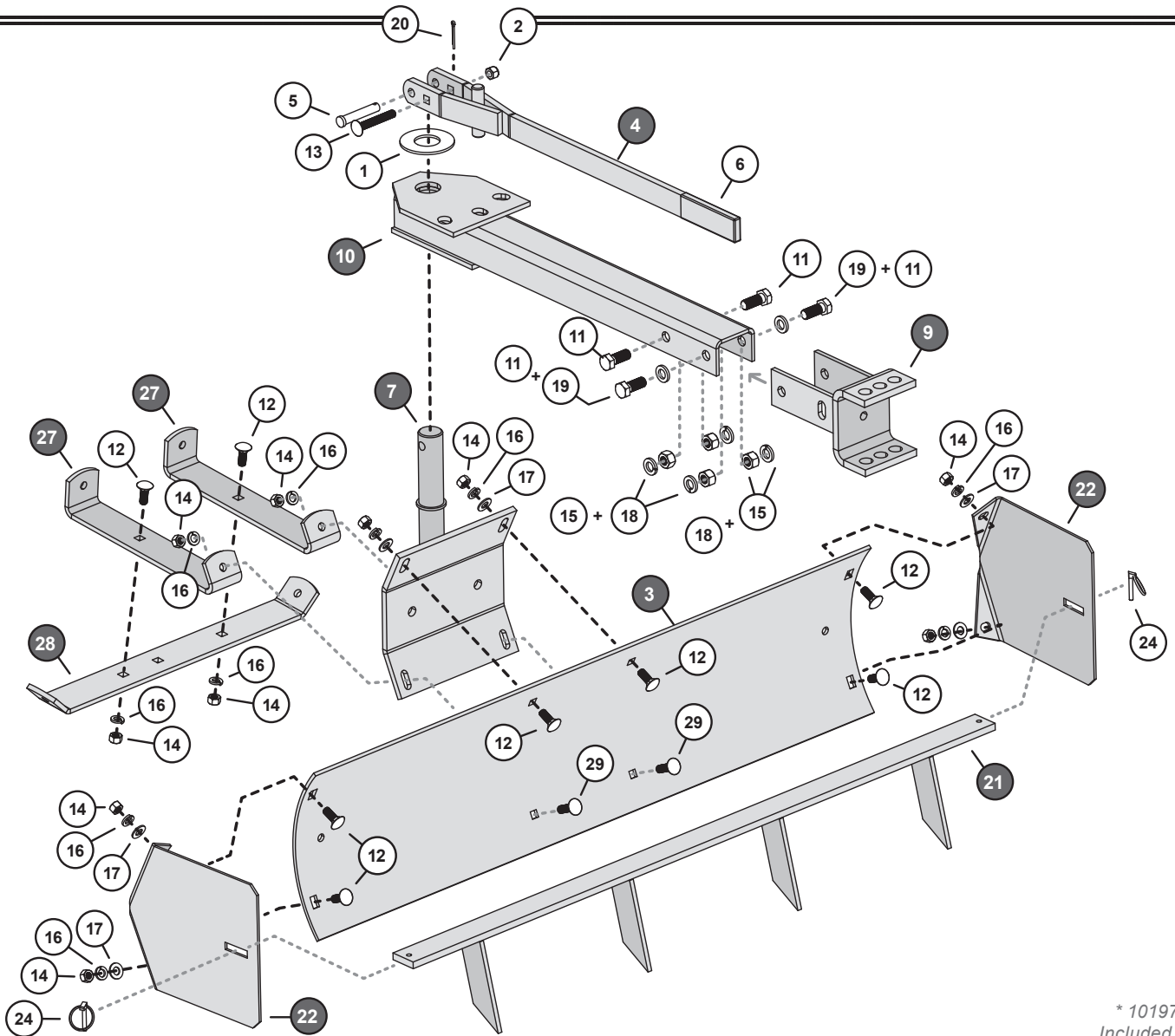

* 1019747
Included on
some models.

Ref #	1019988	Hardware Bag	Qty	Ref #	1019988	Hardware Bag	Qty
1	45M4440P	Washer; SAE, Plain, 1-1/4	1	13	10M1240P	Bolt; Carriage, 3/8 x 2-1/2"	1
2	B-1675P	Nut; Hex Lock, 3/8"-16	1	14	30M1200P	Nut; Reg Hex, 3/8 - 16	10
3	B-4813-10 1019748-10	Blade, 38" Blade, 42"	1 1	15	30M1600P	Nut; Hex, 1/2"-13	4
4	B-2376-10	Angling Lever	1	16	40M1200P	Washer; Lock, 3/8"	10
5	B-2578 1019747*	Pin; Clevis, 7/16 x 2-3/8 Pin; Magnetic Hitch	1 1	17	45M1313P	Washer; SAE Flat, 3/8"	6
6	B-3717	Grip; Vinyl, 3/8 x 1-1/4	1	18	40M1600P	Washer; Lock, 1/2"	4
7	B-2596-10	Blade Mount Plate	1	19	45M1717P	Washer; Flat, 1/2"	2
8	B-5922	Logo Decal	1	20	50M0416P	Pin; Cotter, SS 1/8 x 1"	1
9	B-4265-10	Hitch Assembly	1	21	B-4819-10 1019750-10	Scarifier Bar Assembly, 38" Scarifier Bar Assembly, 42"	1 1
10	B-4351-10	Drawbar	1	22	B-4814-10	Plate; Side	2
11	2M1620P	Bolt; Hex Head, 1/2 x 1-1/4"	4	24	1019983	Pin; Linch, 5/16"	2
12	10M1216P	Bolt; Carriage, 3/8 x 1"	8	27	B-5343-10	Bracket; Weight Mount	2
				28	B-5344-10	Bracket; Weight Support	1
				29	10M1220P	Bolt; Carriage, 3/8 x 1-1/4"	2

PARTS: HARDWARE IDENTIFIER

Illustrations on this page are to scale for faster identification of hardware during assembly.

DO NOT RETURN PRODUCT IF YOU ARE MISSING PARTS.
Please Call: 1 (877) 728-8224

16 Washer: Lock
3/8" (x10)
40M1200P

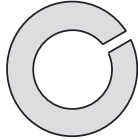

17 Washer: Flat
3/8" (x6)
45M1313P

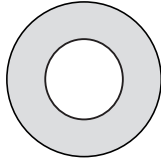

18 Washer: Lock
1/2" (x4)
40M1600P

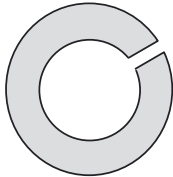

19 Washer: Flat
1/2" (x2)
45M1717P

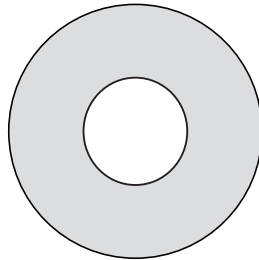

13 Bolt: Carriage, 3/8 x 2-1/2" (x1)
10M1240P

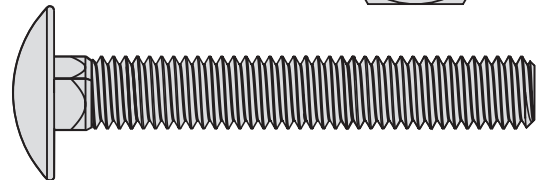

5 Pin, Clevis: 7/16" x 2 3/8" (x1)
B-2578

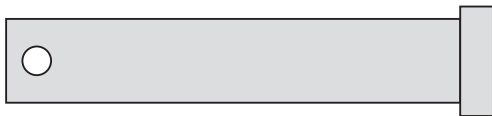

20 Pin; Cotter,
1/8 x 1" (x1)
50M0416P



24 Pin: Linch
5/16 (x2) ...
1019983

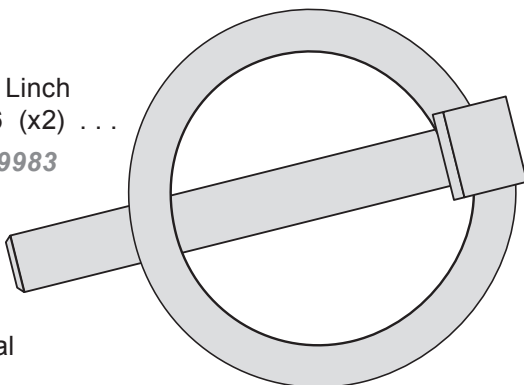

1 Washer: Flat
1-1/4" (x1)
45M4440P

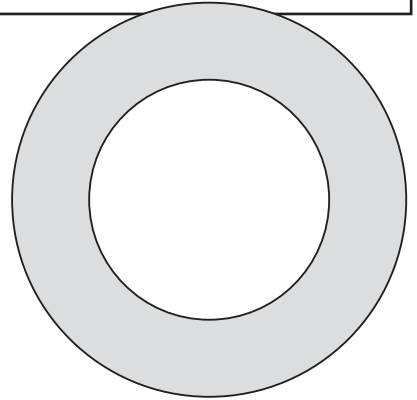

2 Nut: Hex Lock, 3/8" (x1) ...
B-1675P

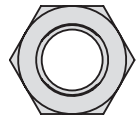

14 Nut: Hex, 3/8" (x10)
30M1200P

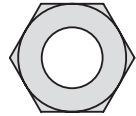

15 Nut: Hex, 1/2" (x4)
30M1600P

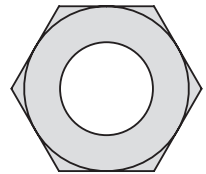

11 Bolt: Hex Head
1/2 x 1-1/4" (x4) ...
2M1620P

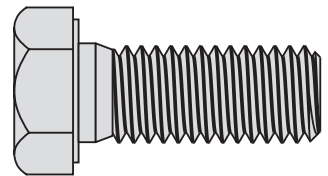

12 Bolt: Carriage
3/8 x 1" (x8)
10M1216P

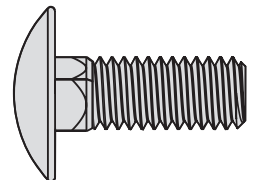

29 Bolt: Carriage
3/8 x 1-1/4" (x2)
10M1220P

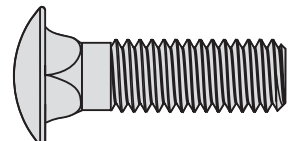

PARTS: CONTENTS OF SHIPPING CARTON

Ref # 1019988 Hardware Bag Qty

Ref #	Part #	Description	Qty
1	45M4440P	Washer; SAE, Plain, 1-1/4"	1
2	B-1675P	Nut; Hex Lock, 3/8"-16	1
5	B-2578	Pin; Clevis, 7/16 x 2-3/8	1
	1019747*	Pin; Magnetic Hitch	1
6	B-3717	Grip; Vinyl, 3/8 x 1-1/4"	1
11	2M1620P	Bolt; Hex Hd, 1/2 x 1-1/4"	4
12	10M1216P	Bolt; Carriage, 3/8 x 1"	8
13	10M1240P	Bolt; Carriage, 3/8 x 2-1/2"	1
14	30M1200P	Nut; Reg Hex, 3/8"-16	10
15	30M1600P	Nut; Hex, 1/2"-13	4
16	40M1200P	LockWasher, 3/8"	10
17	45M1313P	Washer; SAE Flat, 3/8"	6
18	40M1600P	Washer; Lock, 1/2"	4
19	45M1717P	Washer; Flat 1/2"	2
20	50M0416P	Pin; Cotter, SS 1/8 x 1"	1
24	1019983	Pin; Linch, 5/16"	2
29	10M1220P	Bolt; Carriage, 3/8 x 1-1/4"	2

* 1019747 Included on model BS-42BH-A only.

(A) Owner's Manual (x1)
1019911



(B) Hardware Bag (x1)
1019988

(28) Weight Support Bracket (x1)
B-5344-10

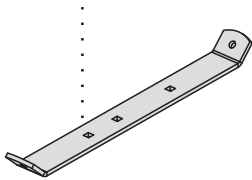

(10) Drawbar Assembly (x1)
B-4351-10

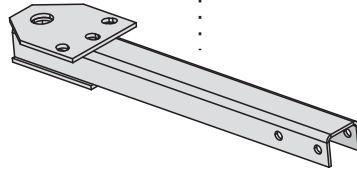

(9) Hitch Assembly (x1)
B-4265

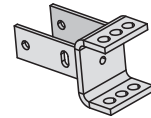

(27) Weight Mount Bracket (x2)
B-5343-10

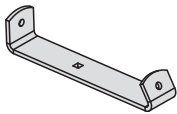

(4) Angling Lever (x1)
B-2376-10

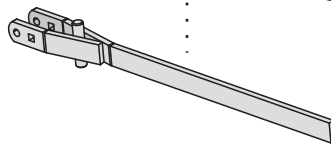

(3) 38" Blade (x1)
B-4813-10

42" Blade (x1)
1019748-10

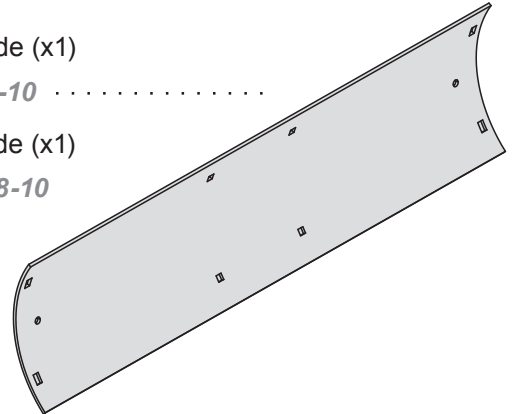

(22) Side Plate (x2)
B-4814-10

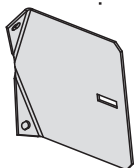

(7) Blade Mount Plate (x1)
B-2596-10

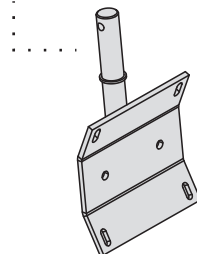

(21) 38" Scarifier Bar Assembly (x1)
B-4819-10

42" Scarifier Bar Assembly (x1)
1019750-10

