



Buy it for looks. Buy it for life.®

# Specifications

## DESCRIPTION

- Metal construction with various finishes identified by suffix
- Includes showerhead, arm, flange and diverter tub spout

## OPERATION

- Handle operates counterclockwise through a 270° arc with off at 6 o'clock and maximum hot at the 9 o'clock position. Shut off in clockwise direction
- Adjustable temperature limit stop to control maximum hot water temperature
- Pressure balancing mechanism maintains selected discharge temperature to  $\pm 3^\circ$

## FLOW

- Showerhead is limited to 2.5 gpm (9.5 L/min) at 80 psi
- EP suffix models are limited to 1.75 gpm (6.6 L/min) at 80 psi

## CARTRIDGE

- 1222 cartridge design
- Accommodates back to back installations
- Nonmetallic, nonferrous and stainless steel material

## STANDARDS

- Third party certified to meet ASME A112.18.1/CSA B125.1 and all applicable requirements referenced therein
- EP suffix models are third party certified to WaterSense®
- ADA  for lever handle

## WARRANTY

- Limited lifetime warranty against leaks, drips and finish defects to the original consumer purchaser
- 5 year warranty if used in commercial installations

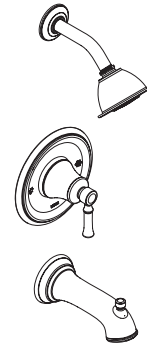

## DARTMOOR™ Single-Handle Tub/Shower Trim Kit

**Models:** T2181 series - valve trim only  
 T2182 series - shower trim only  
 T2183 series - tub/shower trim  
 T62182 (bulk)  
 T62183 (bulk)

**Valves:** 62300 series  
 2500 series

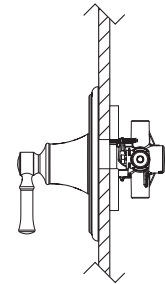
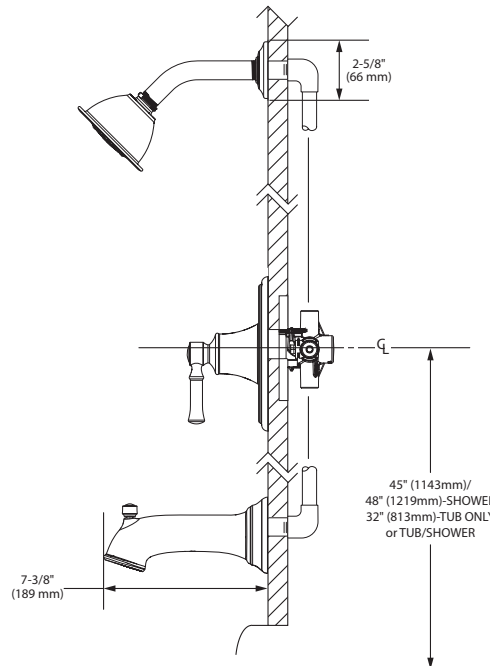
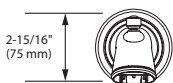
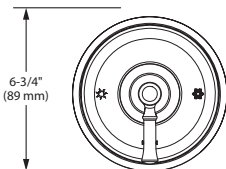
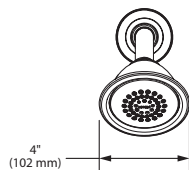
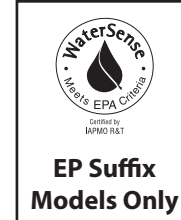

**THICK WALL APPLICATION**

**THIN WALL APPLICATION**



## CRITICAL DIMENSIONS

(DO NOT SCALE)