

REPLACEMENT PARTS LIST

NAPLES 36 IN. VANITY

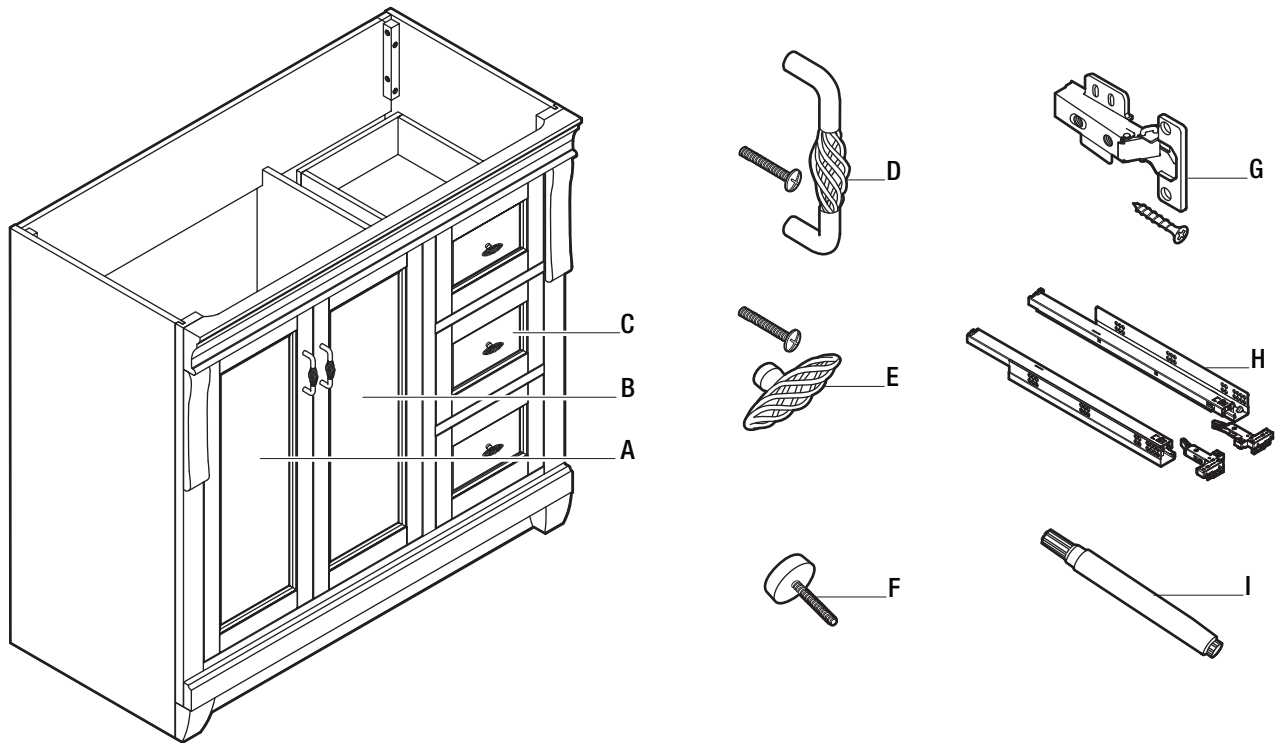

Please use the table below to identify the part number needed, and call FGI Industries, Ltd. Customer Service for your replacement at **888-620-3667**. Our team is available to assist you Monday - Friday, 7:00 A.M. - 5:00 P.M. (CST).

Part	Description	Part #
A	Left Door	PB-NACA3621D-LD
B	Right Door	PB-NACA3621D-RD
C	Drawer	PB-NACA-DRW-COM
D	Door Handle (1 handle; 2 screws)	PB-HANDLE-LS015
E	Drawer Knob (1 knob; 1 screw)	PB-KNOB-LS014
F	Foot Cap	PB-FOOTCAP-JD006
G	Slow Close Hinge (1 hinge; 6 screws)	PB-SC HINGE-HY006
H	Slow Close Drawer Glide Kit (right & left glides; 2 brackets; 14 screws)	PB-DRAWER GLIDEHG006
I	Touch Up Pen	PB-TUKIT006