

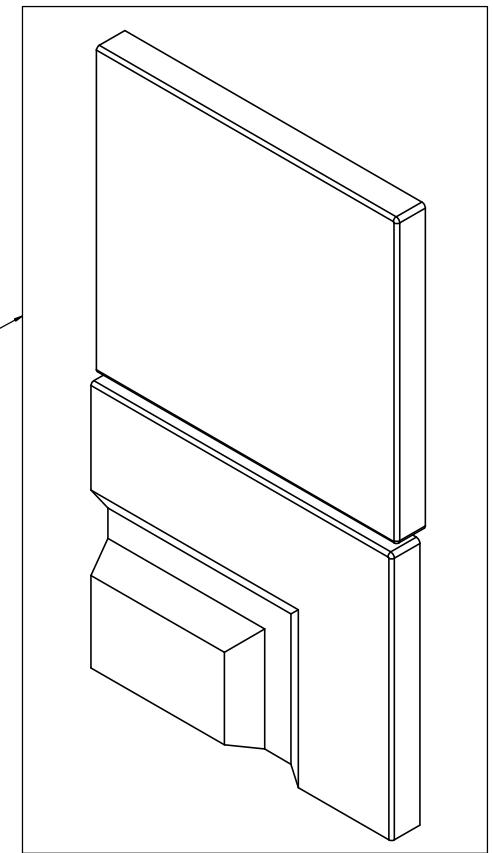

Item ID	Front Thickness [in] mm	Door Thickness [in] mm
BT2135B-WH	[.63] 16	[.63] 16

**This profile  
belongs to  
BT2135B-WH**

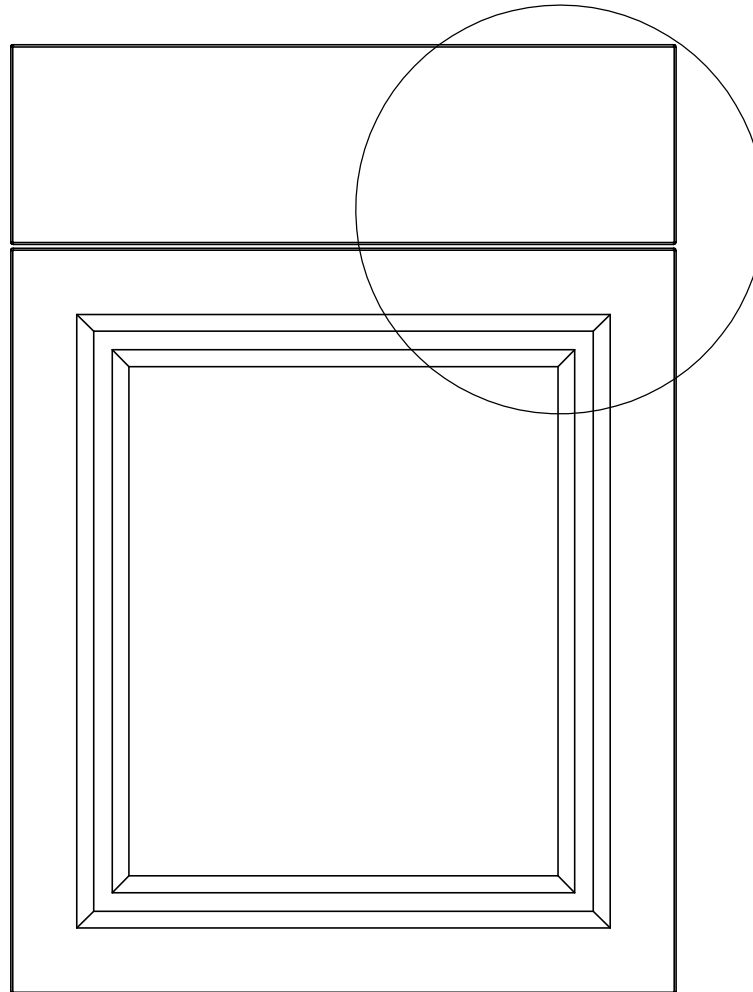

**Detailed View**

<b>Profile: Benton White</b>	
PROPRIETARY AND CONFIDENTIAL THE INFORMATION CONTAINED IN THIS DRAWING IS THE SOLE PROPERTY OF WOODCRAFTERS. ANY REPRODUCTION IN PART OR AS A WHOLE WITHOUT THE WRITTEN PERMISSION OF WOODCRAFTERS IS PROHIBITED.	UNLESS OTHERWISE SPECIFIED DIMENSIONS ARE IN MM AND [INCHES] TOLERANCES ARE +.039[1]-.039[1] SCALE:1:2
	

Item ID	Shelf Thickness [in] mm	Shelf Length and Width [in] mm	Depth "X" [in] mm
BT1835D-BT	N/A	N/A	[24.60] 625
BT1835D-WH	N/A		[24.44] 621
CM1835D-DK	N/A		[24.60] 625
CM1835D-WH	N/A		[24.44] 621
EH1835D-GB	N/A		[24.60] 625
BT1835D-RC	N/A		[24.60] 625
CM1835D-KG	N/A		[24.44] 621

Description					
Kitchens - Drawer Base Cabinet 18 with 3 Drawers					
REV	ECO#	Description	REV'D BY DATE	CHK'D BY DATE	APRV'D BY DATE
3		Structural Change	07/25/18	07/25/18	07/25/18

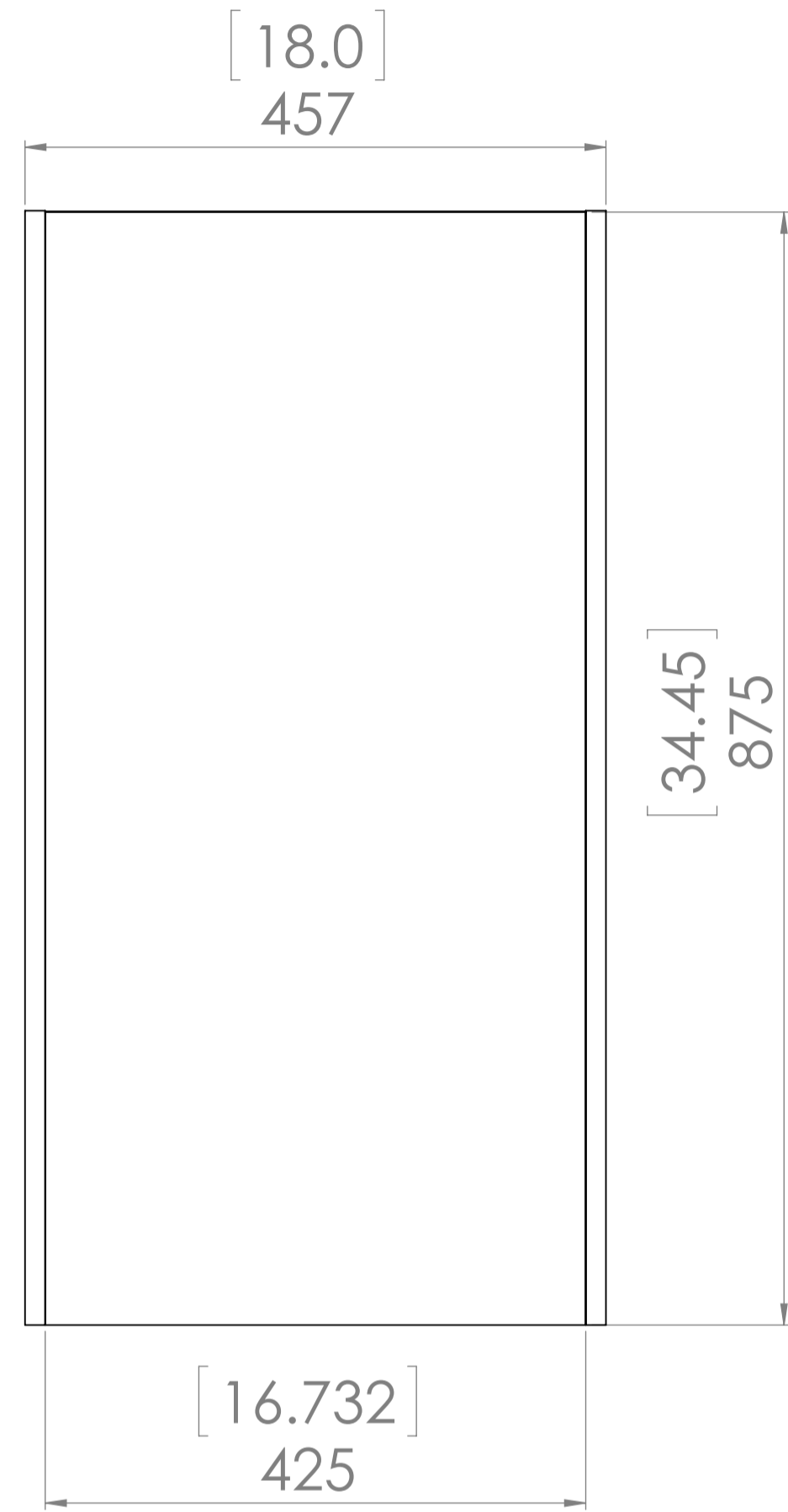

**Back View**

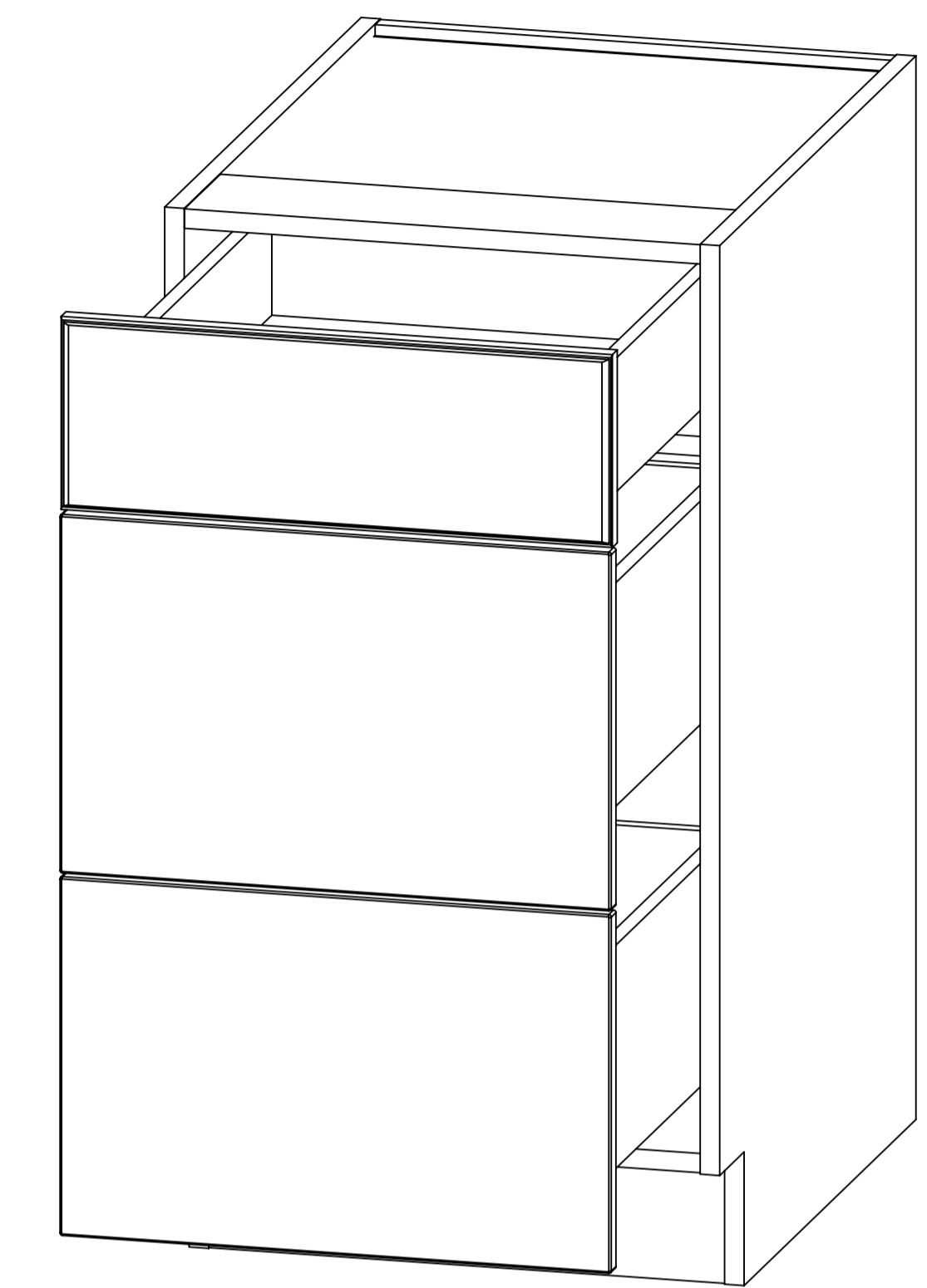
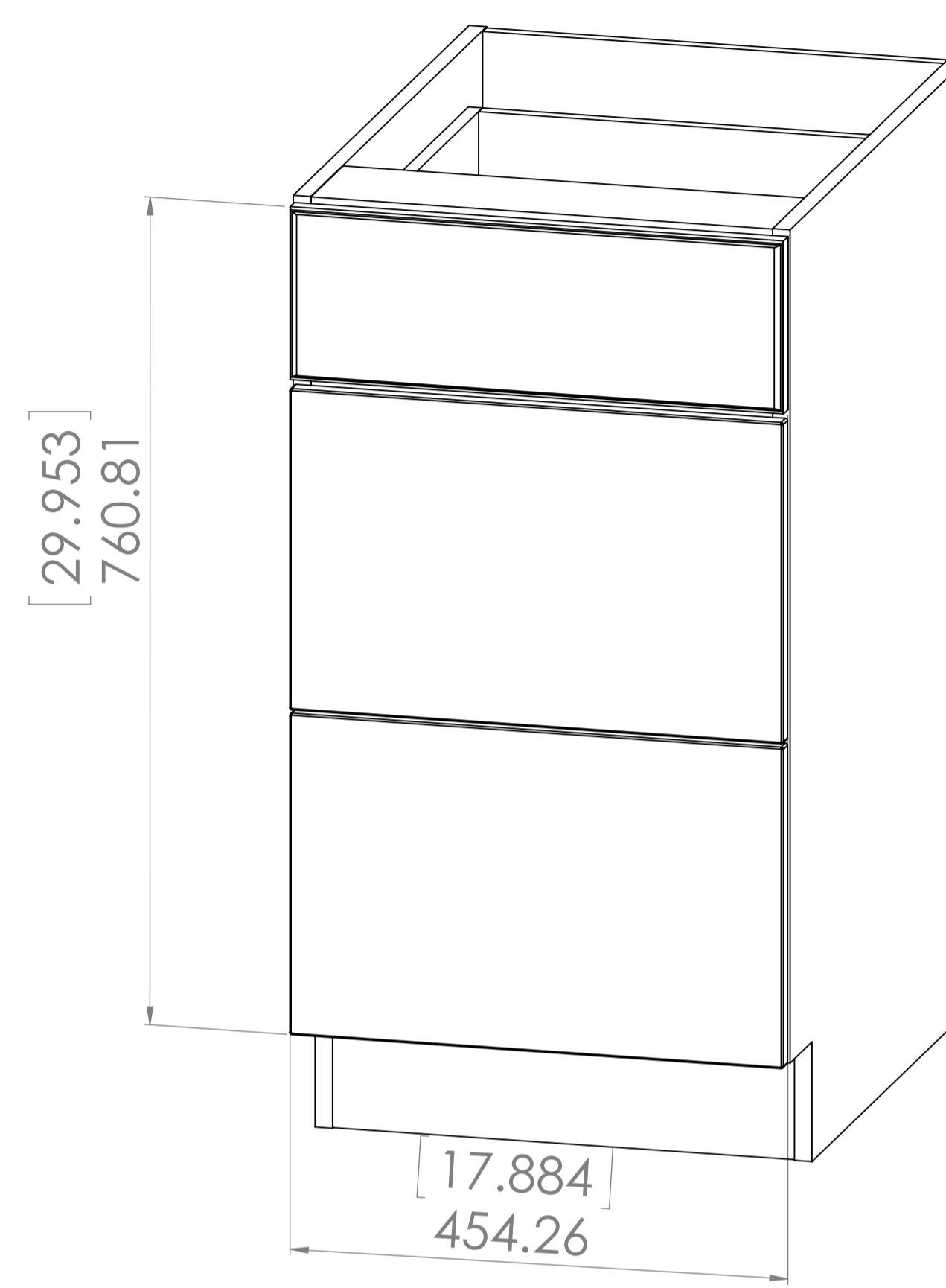

**Isometric View**

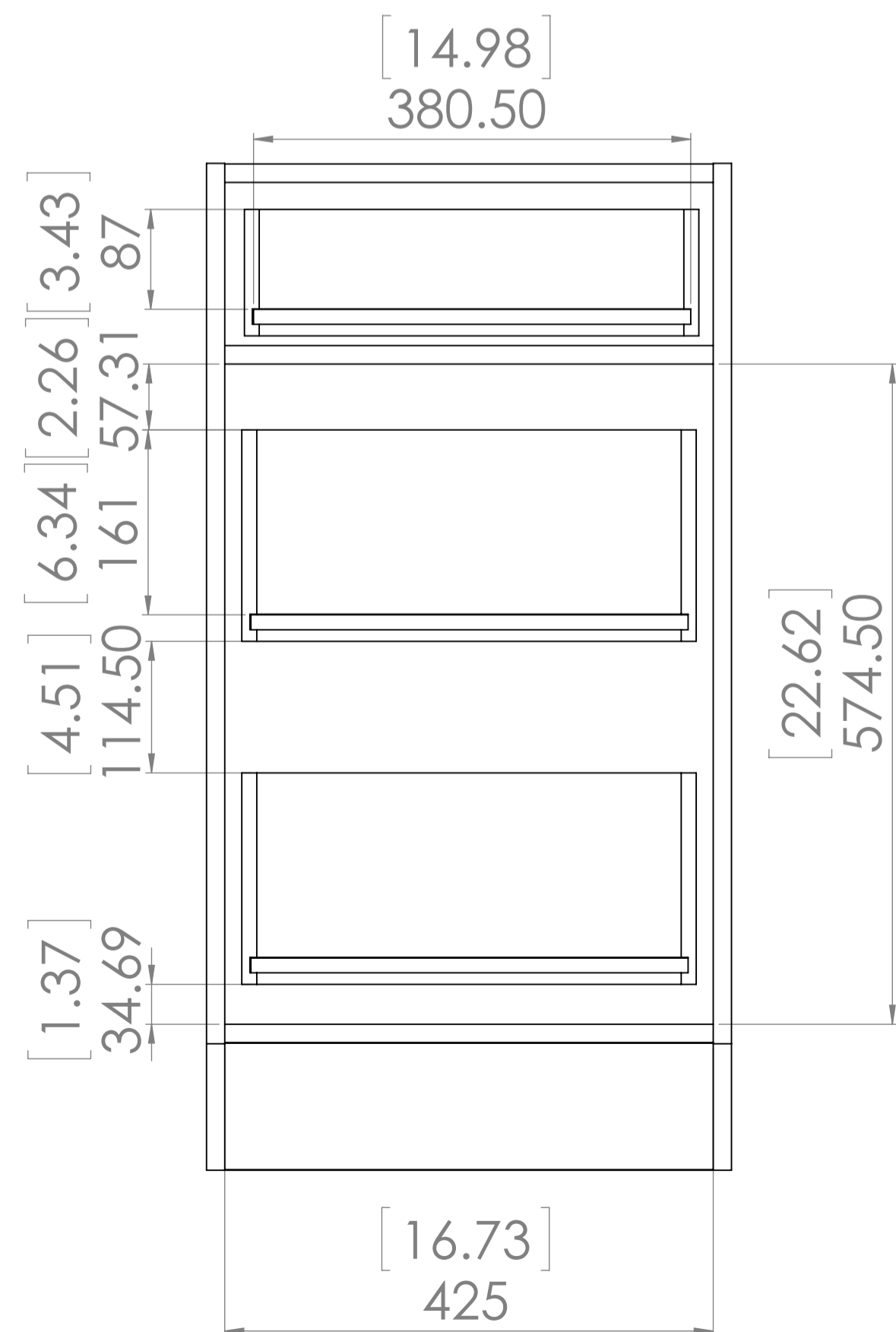

**Front View (front door removed)**

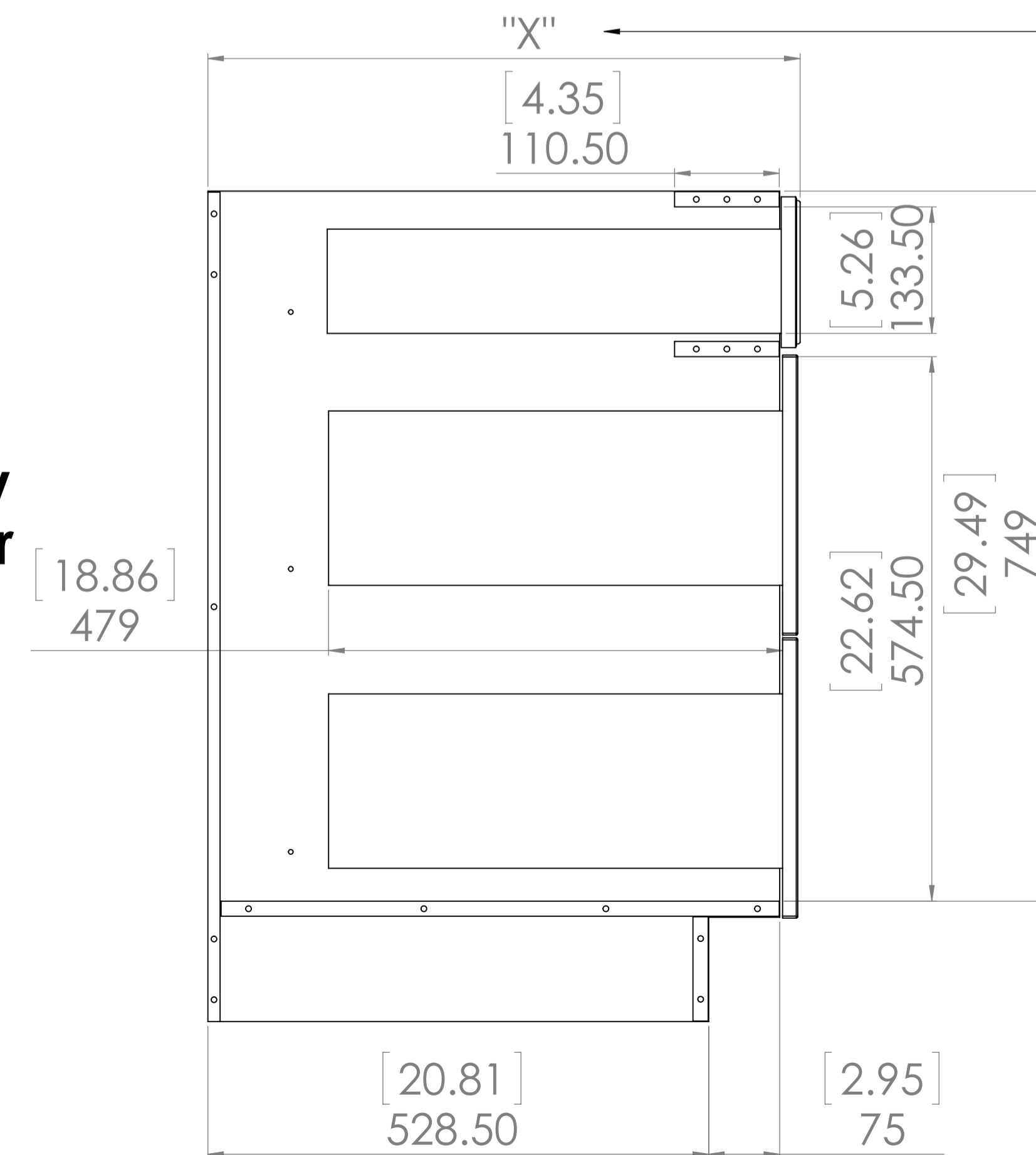

Depth "X" depends on door profile

**Side View (left panel removed)**

	NAME	SIGNATURE	DATE	MATERIAL:
DRAWN	R. Rubio		11/09/17	Plywood CM-WH.
CHK'D	R. Rubio		11/09/17	Particle Board the
APPV'D	R. Rubio		11/09/17	other Cabinets.
MFG	R. Rubio		11/09/17	

UNLESS OTHERWISE SPECIFIED  
DIMENSIONS ARE IN mm. AND (INCHES)  
TOLERANCES ARE +/- 1[0.039]  
SCALE: 1:5

PROPRIETARY AND CONFIDENTIAL  
THE INFORMATION CONTAINED IN THIS DRAWING IS THE SOLE PROPERTY OF WOODCRAFTERS. ANY REPRODUCTION IN PART OR AS A WHOLE WITHOUT THE WRITTEN PERMISSION OF WOODCRAFTERS IS PROHIBITED.

**Wood Crafters**

Drawer\_Base\_18in

3

SCALE: 1:5

SHEET 1 OF 1