

Congratulations on choosing the Canopy Breeze® canopy fan, the next level of tailgating comfort! To ensure maximum enjoyment and years of trouble-free service from this product, please read these instructions thoroughly and store them in a safe place. Please visit www.mekooutdoors.com for further information and instructional videos.

One-Year Limited Warranty

Meko Outdoors, Inc warrants this product to be free from defects in material or workmanship for a period of one (1) year following the date of purchase, provided the product is used in a non-commercial manner. This limited warranty does not cover failures as a result of abuse, droppage, or using this product in a manner contrary to its intent. Damage caused by collapsed/toppled canopies as a result of wind or other acts of nature are excluded from this warranty. For warranty inquiries or claims, **please do not return the unit to your retailer.** Email us at service@mekooutdoors.com with your inquiry.

What's Included

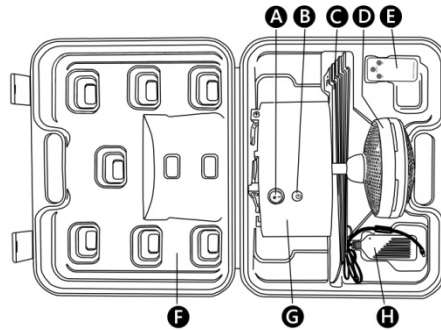
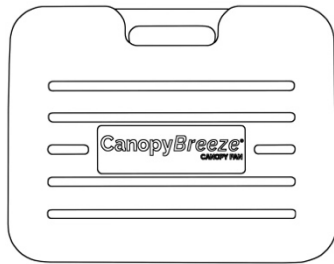

- A** Master power switch
- B** Charging port
- C** 5 fan blades
- D** Motor Assembly
- E** Fan remote control
- F** Case
- G** Battery Housing
- H** Battery charger

Compatible Frames

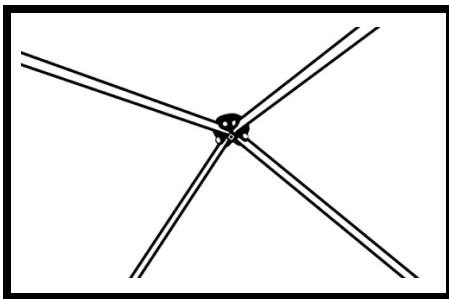

Standard or vented 10' and 12' canopies with perpendicular roof joists, available in most sporting, home improvement and discount stores.

NON-Compatible Frames *Canopy Breeze will not fit on these type frames*

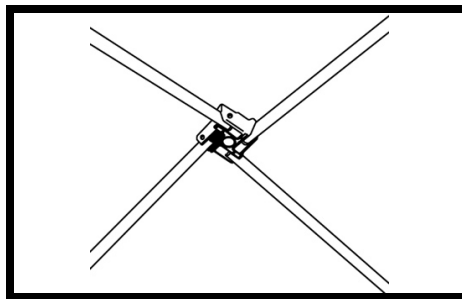

Offset roof joist members

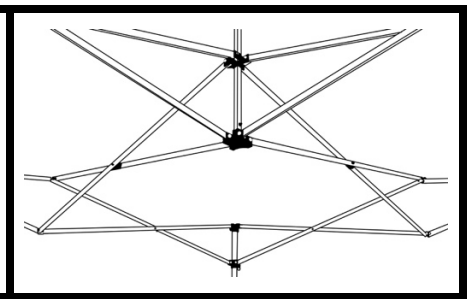

Canopies with a center pole

Installation

⚠ WARNING: Do not install or operate the fan if rain, windy or inclement conditions are expected.

⚠ WARNING: Be sure to secure the canopy with stakes, weights or rope when operating the fan.

💡 Vented canopies will pull more air than enclosed canopies, creating a more comfortable environment.

💡 If sustained winds are expected to be 10 mph or higher, the breeze from the fan will be largely ineffective.

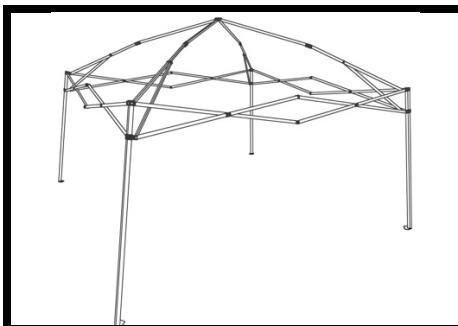

① Unfold canopy; only raise it halfway up.

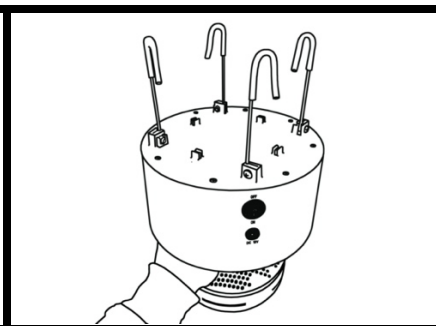

② Raise the four hooks on top of the fan.

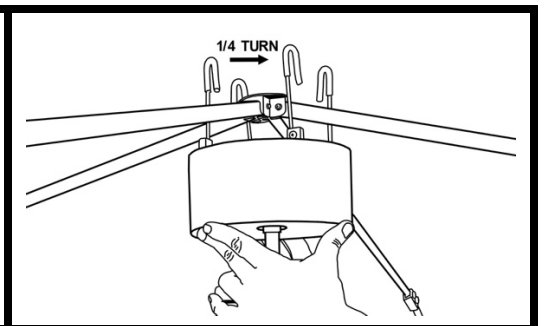

③ Center the hooks between the four roof joists of the canopy frame apex with the hooks over the top of the frame. Rotate the fan 1/4 turn counterclockwise, then lower each hook onto a roof joist.

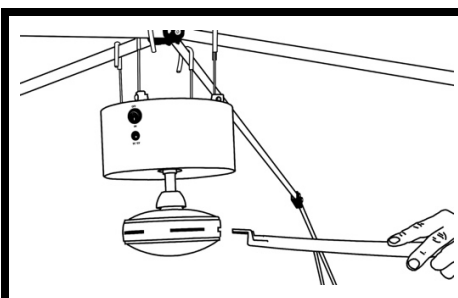

④ Insert each of the five fan blades into the slots on the fan motor assembly and push firmly.

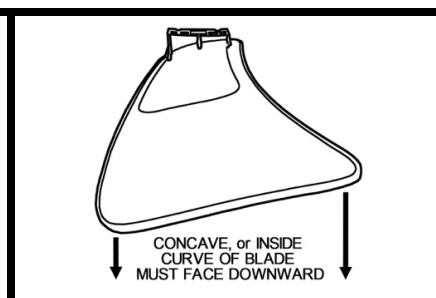

⑤ The inner curve, or concave side of fan blade must face downward (toward the ground) when installed.

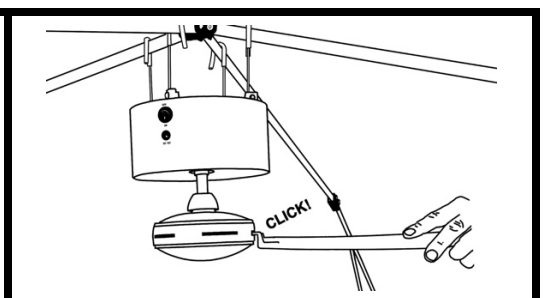

⑥ You will hear a "click" once the fan blade snaps into place.

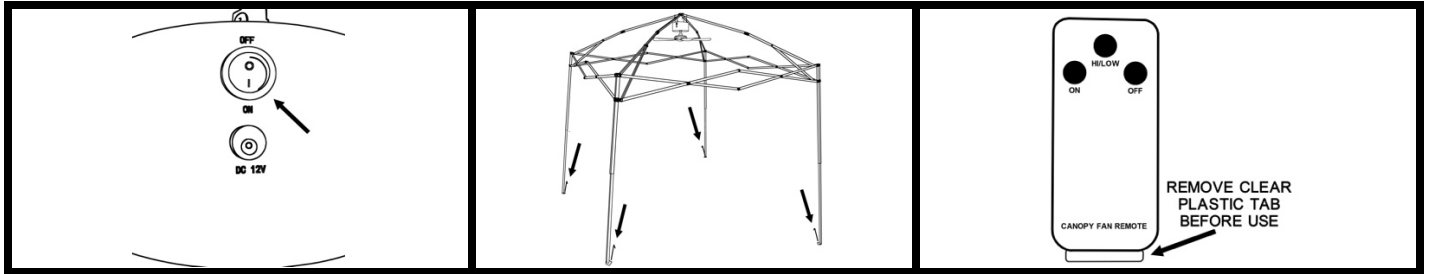

⑦ Once all the fan blades are in place, turn the Master Power Switch to the "ON" position **BEFORE** raising the canopy. It will be hard to reach otherwise.

⑧ Stake the canopy legs securely, place the fabric top on the canopy, and raise it to full height.

⑨ Remove the clear plastic tab from the back of the remote and discard before use. You can now operate the fan using the remote control.

Uninstalling Canopy Breeze®

1. Turn the fan off using the remote.
2. Lower the canopy back to the half-height position.
3. Flip the Master Power Switch to the "OFF" position.
4. Remove the fan blades. While holding the motor assembly, grasp the front of the blade firmly. Slightly wiggle the blade from side to side while pulling until the blade slides out. If the blades still won't release, remove the fan from the canopy frame and place it upside down on a firm surface, such as a table to remove the blades. Note that the blades will become easier to remove over time.
5. Lift the fan unit up over the canopy frame and rotate clockwise ¼ turn to remove.
6. Lower the hooks and snap them back into their cradles on the top of the battery housing.
7. Place all components back into the case and locks clasps securely.
8. **⚠ Please be sure Master Power Switch is in the "OFF" position when storing the fan. If not, the remote could inadvertently start the motor and cause damage to the fan and or case.**

Center Hoop for Hook Mounting

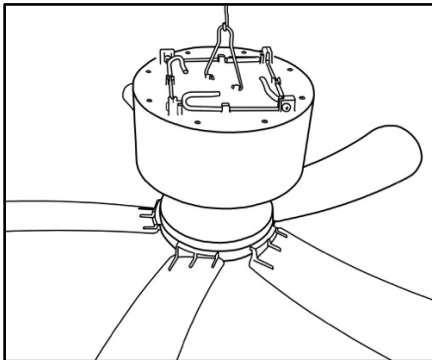

Your fan comes with a hoop on the top for installation on a hook. This will allow for use in other applications in addition to canopies. Please use extreme care when hook mounting:

1. We recommend a hook that is #10 size or bigger, and must support at least 10 lbs.
2. If hanging from a ceiling or gazebo, please be sure the hook is attached directly into the wooden frame or stud under drywall. Do not use hooks that are mounted only in drywall, even if using a drywall anchor.
3. Allow a minimum of 7.5' of clearance between the fan blades and ground, or 6" higher than the tallest occupant.
4. Once the fan is placed on the hook, secure it with a zip or wire tie for extra safety.

Charging and Battery Care

⚠ WARNING: Only recharge this product with the supplied charger.

1. Before first use, the battery must be charged at least 12 hours.
2. Plug the charger into a standard 120 Volt 60 Hz electrical outlet. While charging, the LED in the charger will illuminate red. When charging is complete, it will illuminate green.
3. Typical recharge time after use is 5 hours from 10% battery charge.
4. **Battery disposal.** This product uses a Lithium-ion rechargeable and recyclable battery. When the battery will no longer hold a charge, it should be removed from the fan and recycled. It should not be incinerated or composted. Contact your local recycling center for information on where to dispose of it properly. In the event the battery in your fan needs replacing, please contact us at service@mekooutdoors.com for instructions and pricing.
5. **Battery Tips.** The powerful lithium-ion battery included with your fan is by far its most expensive component. Maximize the life of your battery with these handy tips:
 - a. Try to avoid "deep discharge" by not letting the battery drain completely.
 - b. It's best to store the fan in an environment of 80°F or cooler. Try not to leave in the fan in a hot car for an extended period of time.
 - c. Once the charger illuminates green, unplug it. The battery will discharge approximately 5% over the next several days, and you can "top it off" the day before its next use.
 - d. When storing the fan for long periods of time, only charge the battery to 30-50%. Try to avoid storing the battery at 100% charge for an extended period as this will shorten battery life.
 - e. When using the fan regularly, it is OK to run it for a short period of time, then recharge the battery back to full. Lithium-ion batteries do not have "battery memory," so partial discharge/recharge will not harm them.

Troubleshooting

If after installation the fan will not operate, try one of the following:

1. Was the fan fully charged before first use, with the LED on the charger illuminating green?
2. Was the Master Power switch on the fan body moved to the ON position before raising the canopy to full height?
3. Was the clear plastic battery safety tab removed from the back of the remote?
4. Does the LED on the front of the remote light up red when any buttons on the remote are pushed?

If all the above steps have been taken, and the fan still will not operate, please contact us at service@mekooutdoors.com for further assistance.

For questions and further information, please visit our website, www.mekooutdoors.com or email us at service@mekooutdoors.com.