

Assembly Instructions

Caution : You must read this before you proceed

Expandable Table

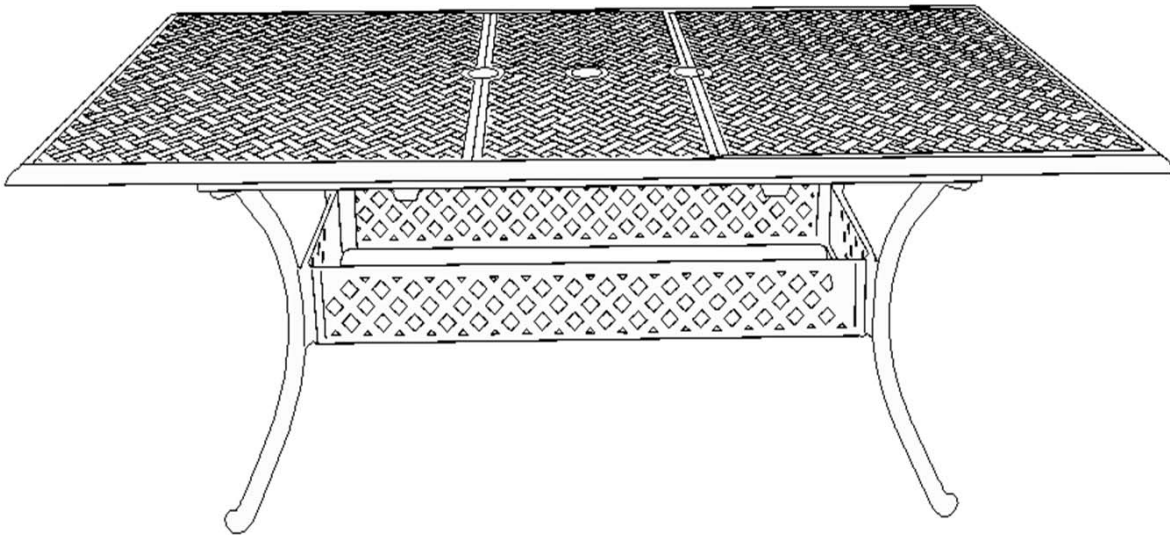





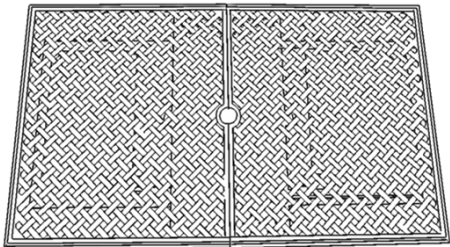

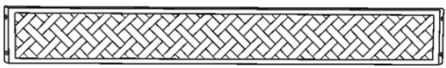
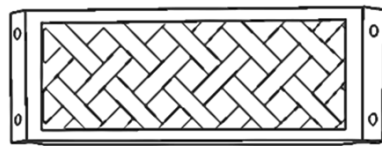
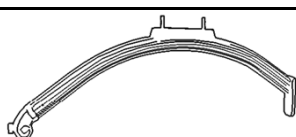
CAUTION : This table is NOT a TOY.
Keep your child / children at bay in the process of assembly.

Parts List

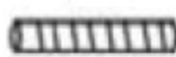
Label	Picture	Description	QTY
A		Table Top	1

B		Long Leg Support	2
C		Short Leg Support	2
D		Table Leg	4

Hardware

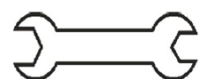
Label	Picture	Description	QTY
①		Studs(M8*40mm)	5
②		Washers(8mm)	13
③		Spring washers(8mm)	13
④		Nuts (8mm)	13
⑤		Nuts Cap (8mm)	9
⑥		Screwdriver	1
⑦		Spanner	1

Assembly Preparation

Before Beginning Assembly:

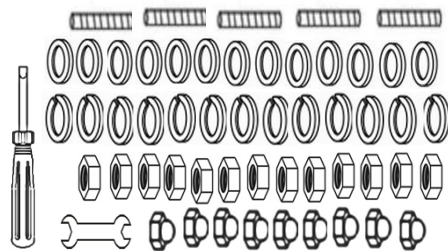
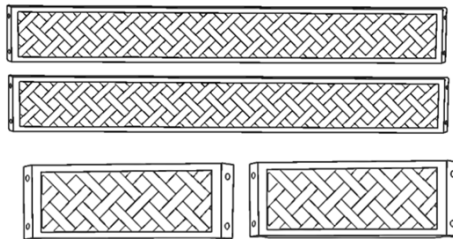
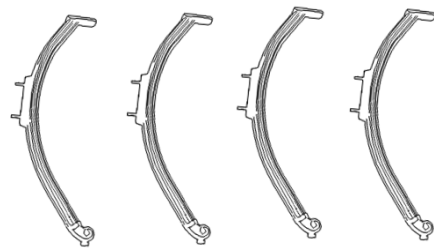
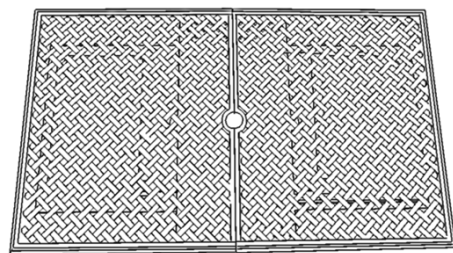

- Read instructions, cover to cover-



- Have 2 adults on hand for assembly-



- Do not assemble on flooring or carpet-



- Assemble on a clean non-marring surface (packing foam)-



- Save all packaging until finished-

Assembly Steps

Overview

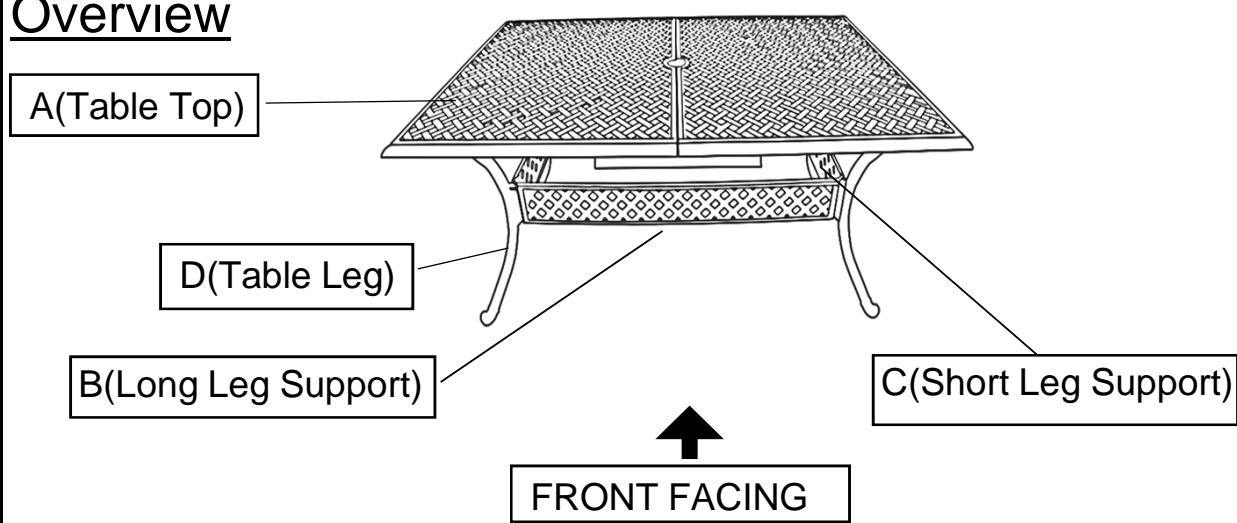

This table has multiple parts and may require up to 30 minutes to assemble. To give you an overview of the table parts, the above picture is to help you put the various parts into perspective. Please read through the instructions below to familiarise yourself with the parts and steps before assembly.

Step 1

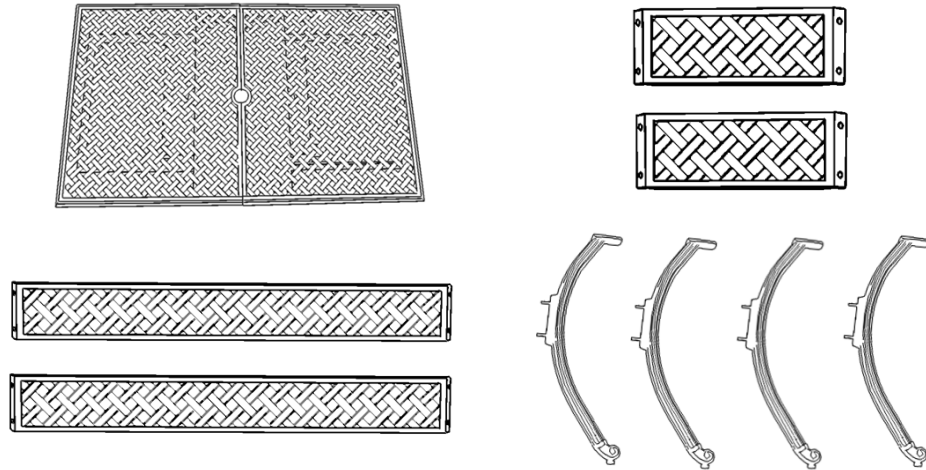

Unpack and place all parts on a clean soft surface.

Step 2

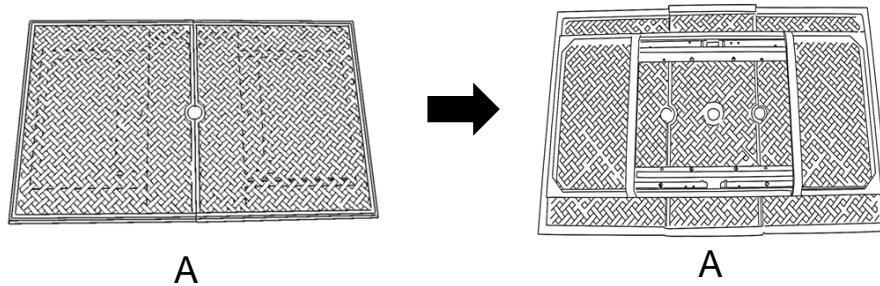

Turn the Table Top upside down on to a clean soft surface.
Caution: you may need 2 adults to turn the table top A upside down.

Step 3

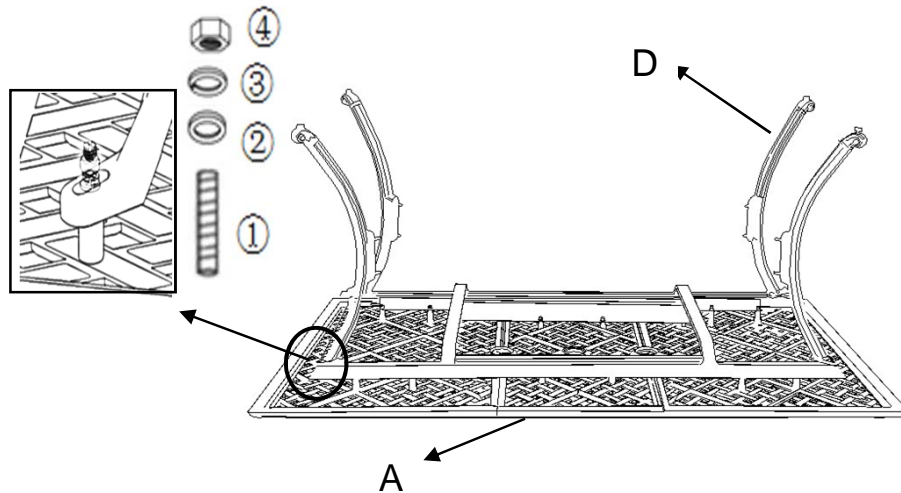

Tighten the Studs(①) first on the Table Top(A) by Screwdriver (⑥).

Then attach four Table Legs(D) to the mounting position on the Table Top(A) with Studs(①), Washers(②), Spring Washers(③) and Nuts(④) by Spanner(⑦).

Do Not Overtighten all nuts.

Step 4

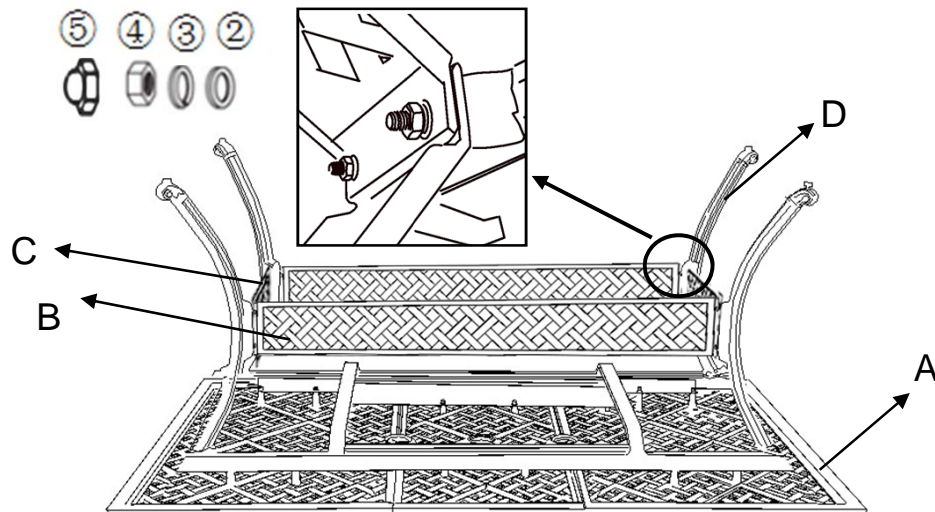

Attach four Leg Support to the mounting position with Washers(②), Spring Washers(③), Nuts(④) and the Nuts Cap (⑤) by Spanner(⑦).

Do Not Overtighten all nuts.

Step 5

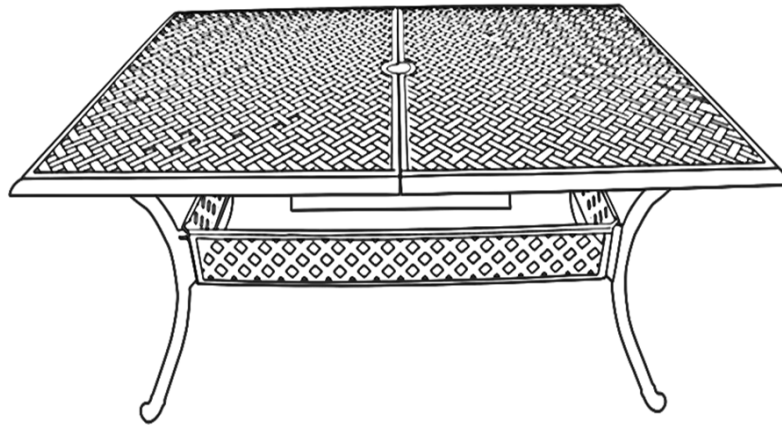

Turn the Table rightside up.
Adjust the pre-installed Leveller until the Table is level with the ground.
Then, proceed to tighten all Bolts and Nuts.
Your table is ready for use.

Step 6

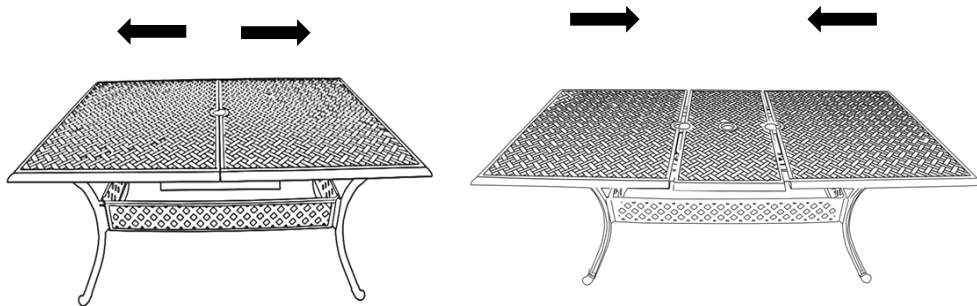





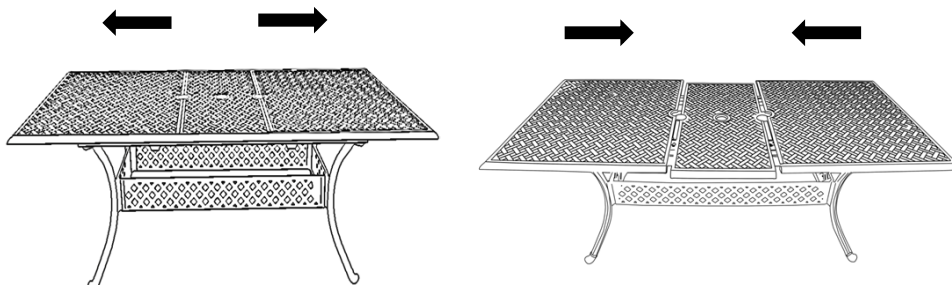

To expand the Table, pull the table top apart, then the central panels will go up, and then push the Table Top back to the center until the Table top is flush.

Step 7



To shorten the Table, pull the table top apart, then the central panels will go down, and then push the Table Top back to the center until the Table top is flush.

Care & Maintenance

-   ● Do not put hot items directly on furniture surface.
 -   ● Do not clean furniture with harsh cleansers or polish.
 -   ● To obtain the longest lifespan of your outdoor products, minimizing exposure to direct sunlight is recommended.
 -   ● Children should not climb or jump on the furniture.
 -   ● Do not write on furniture without a padded barrier to protect the surface.
 -   ● To obtain the longest lifespan of your outdoor products, avoid extended and lengthy exposure to rain, snow, and direct sunshine. Whenever possible cover the product and /or place under patio or awnings.
 -   ● Not for commercial use. For residential use only.
 -   ● Stains may be removed with mild soap solution and damp cloth.
 -   ● Keep away from sources of ignition.
-
-   ● Dust and pick-up spills using a clean, non-colored, lint-free cloth.

What Is Proposition 65?

Proposition 65 is a California law that requires warning labels on products that may contain one of more than 800-plus chemicals or ingredients that the California Office of Environmental Health Hazard Assessment (OEHHA) has deemed to cause cancer or other reproductive toxicity. Chemicals and elements on this list include wood dust, brass, and other everyday substances, which can be found in very common household items, such as: lamps, tableware, jewelry, crystal glasses, electric cords, beauty products, automobiles, and furniture.

Why Did I Find a Proposition 65 Warning on My Home Goods Product?

We include Proposition 65 warnings on all of our products because there is always a chance that one of the 800-plus common chemicals and ingredients listed under this law could potentially be on our furniture or packing materials. We risk large fines under this law, if we don't include this warning.

Should I worry?

We realize you may be worried finding this warning on our products, but we want to reassure you that the hazardous exposure limits for any of these chemicals have never been found on furniture products that we've shipped to our customers. Additionally, this warning label is very common and can be found on almost every piece of furniture sold in the state of California.

Just How Common Are Proposition 65 Warnings?

Proposition 65 warnings have become so common in California that it is hard to take a trip to a local bank, grocery store, or restaurant without finding at least one warning. In fact, even the Disney Land Resort has a Proposition 65 warning:

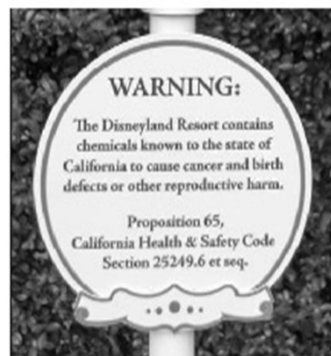

Assembly Instructions



Caution : You must read this before you proceed.

CHAIR

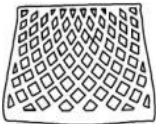
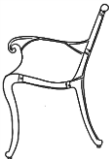

**CAUTION : This Chair is NOT a TOY.
Keep your child / children at bay during the assembly process.**

Parts list

No.	Picture	Description	Qty
A		Backrest Panel	1
B		Chair Seat Panel	1
C		Left Leg with Arm(with pre-attached Levellers)	1
D		Right Leg with Arm(with pre-attached Levellers)	1





Hardware

No.	Picture	Description	Qty
①		Washer (8mm)	9
②		Spring Washer (8mm)	9
③		Nut (8mm)	9
④		Rubber Cap	5
⑤		Spanner	1

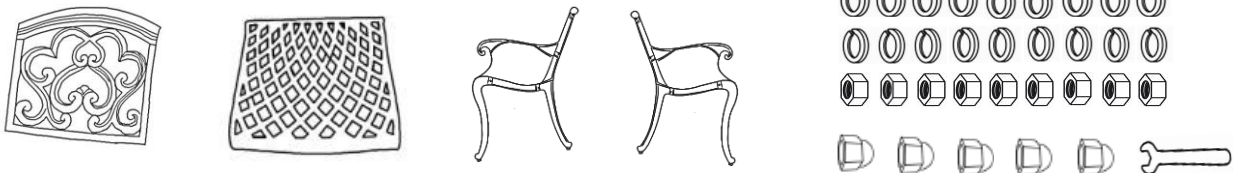
Assembly Preparation

Before Beginning Assembly:



-  • Read instructions, cover to cover-
-  • Have 2 adults on hand for assembly-
-  • Do not assemble on flooring or carpet-
-  • Assemble on a clean non-marring surface (packing foam)-
-  • Save all packaging until finished-

Assembly Steps

Overview

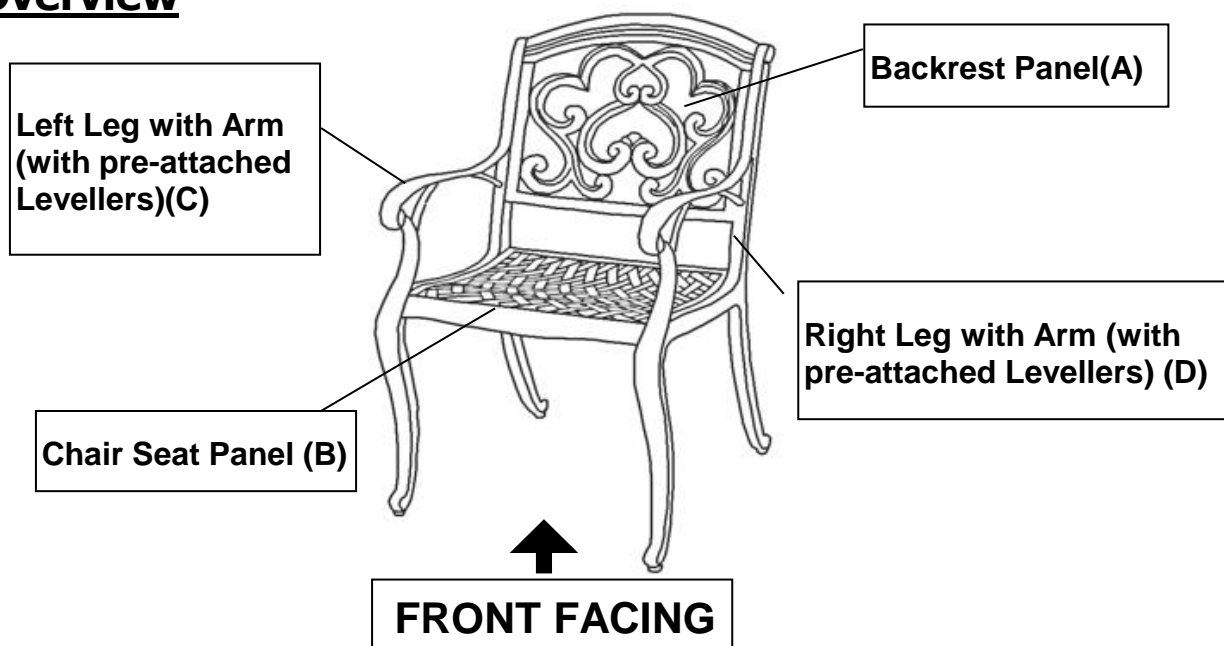

This Chair has multiple parts and may require up to some 30 minutes to assemble.

To give you an overview of the Chair parts, the above picture is to help you put the various parts into perspective.

Please read through the instructions below to familiarise yourself with the parts and steps before assembly.

Step 1

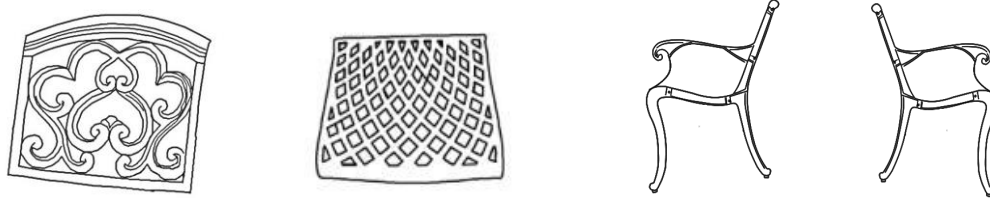

Unpack and Place all parts on a clean, soft surface.

Step 2

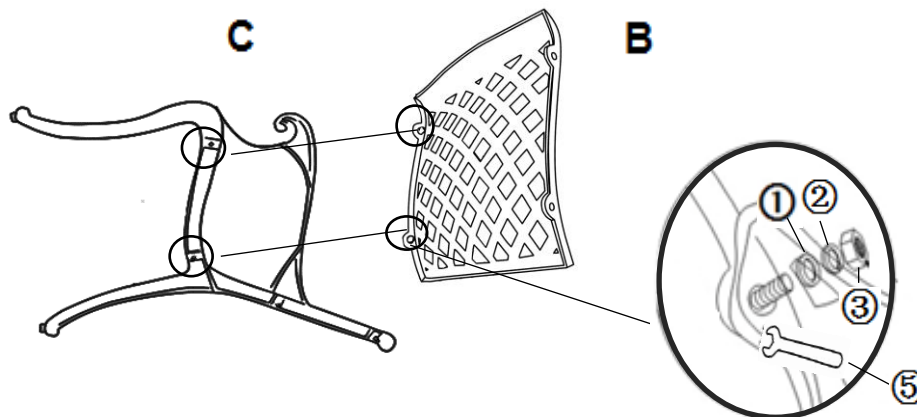

Attach the Chair Seat Panel(B) to the Left Leg with Arm (with pre-attached Levellers) (C) using Washers(①), Spring Washers(②) and Nuts(③), with Spanner(⑤).

DO NOT fully tighten at this stage.

Step 3

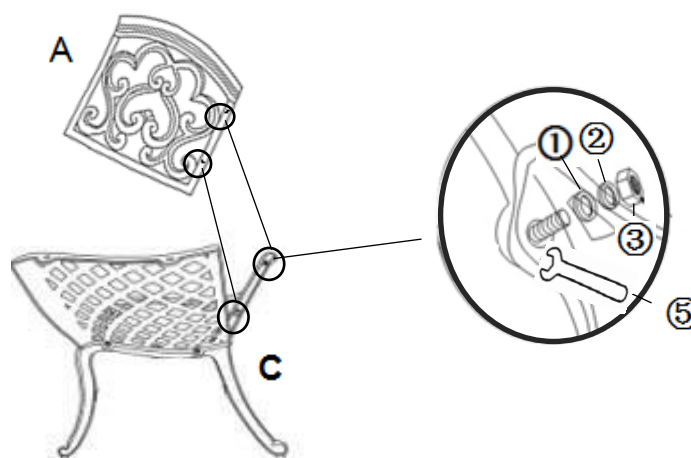

Then attach the Backrest Panel(A) to the top end of the Left Leg with Arm (with pre-attached Levellers) (C) using Washers(①), Spring Washers(②) and Nuts(③), with Spanner(⑤).

Do not fully tighten .

Step 4

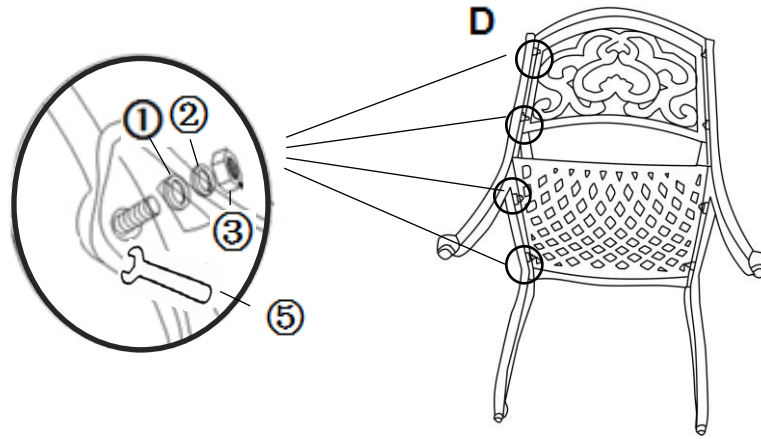

Repeat the same assembly process for the Right Leg with Arm (with pre-attached Levellers)(D) .
DO NOT fully tighten at this stage.

Step 5

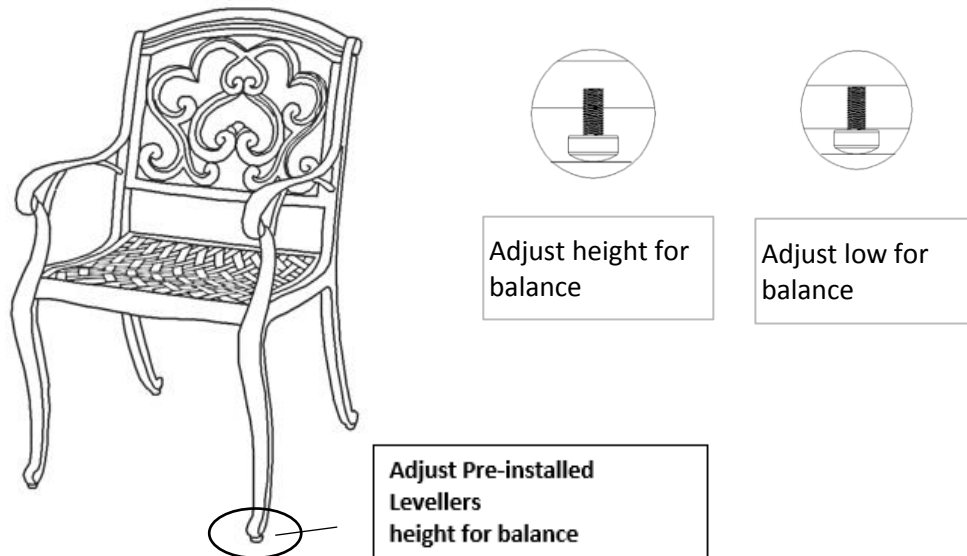

Stand the chair rightside up.

Now, fully and securely, tighten all nuts, at all joints.



















Add Rubber Caps (④) on all bolt ends to protect skin or clothing from getting snagged.

Adjust the Pre-attached levellers at the bottoms of the chair legs until the chair is level with the ground.

Your chair is ready for use.

Caution: This Chair can only be used on a flat, level surface.

Care & Maintenance

-   ● Do not put hot items directly on furniture surface
 -   ● Do not clean furniture with harsh cleansers or polish.
 -   ● To obtain the longest lifespan of your outdoor products, minimizing exposure to direct sunlight is recommended.
 -   ● Children should not climb or jump on the furniture.
 -   ● Do not write on furniture without a padded barrier to protect the surface.
 -   ● To obtain the longest lifespan of your outdoor products, avoid extended and lengthy exposure to rain, snow, and direct sunshine. Whenever possible cover the product and /or place under patio or awnings.
 -   ● Not for commercial use. For residential use only .
 -   ● Stains may be removed with mild soap solution and damp cloth.
-
-   ● Dust and pick-up spills using a clean, non-colored, lint-free cloth .

What is Proposition 65?

Proposition 65 is a California law that requires warning labels on products that may contain one of more than 800-plus chemicals or ingredients that the California Office of Environmental Health Hazard Assessment (OEHHA) has deemed to cause cancer or other reproductive toxicity. Chemicals and elements on this list include wood dust, brass, and other everyday substances, which can be found in very common household items, such as: lamps, tableware, jewelry, crystal glasses, electric cords, beauty products, automobiles, and furniture.

Why Did I Find a Proposition 65 Warning on My Home Goods Product?

We include Proposition 65 warnings on all of our products because there is always a chance that one of the 800-plus common chemicals and ingredients listed under this law could potentially be on our furniture or packing materials. We risk large fines under this law, if we don't include this warning.

Should I worry?

We realize you may be worried finding this warning on our products, but we want to reassure you that the hazardous exposure limits for any of these chemicals have never been found on furniture products that we've shipped to our customers. Additionally, this warning label is very common and can be found on almost every piece of furniture sold in the state of California.

Just How Common Are Proposition 65 Warnings?

Proposition 65 warnings have become so common in California that it is hard to take a trip to a local bank, grocery store, or restaurant without finding at least one warning. In fact, even the Disney Land Resort has a Proposition 65 warning:

