

Assembly Instructions

Armchair

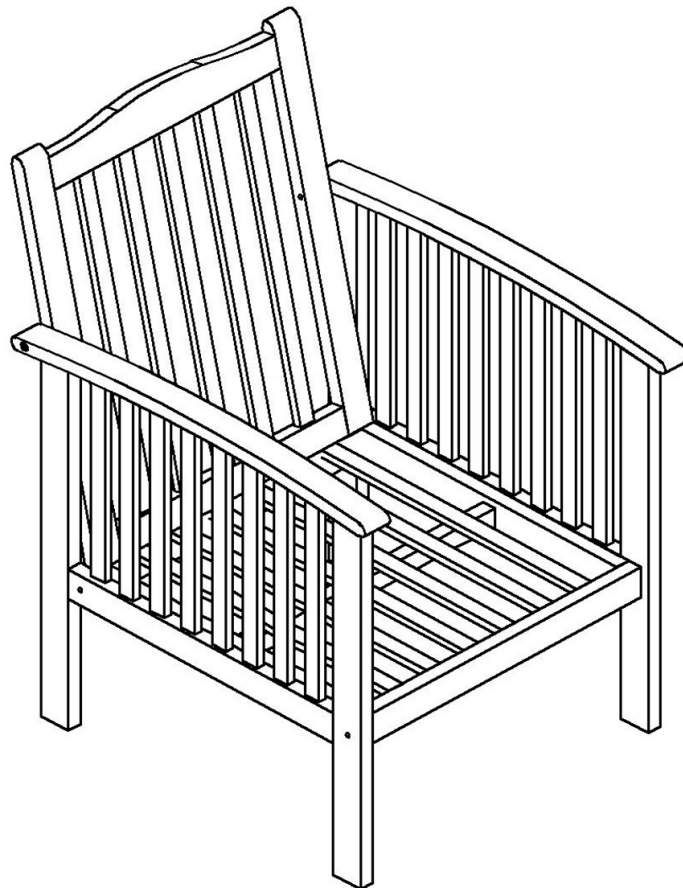

CAUTION : This is NOT a TOY assembly.
Keep your child / children at bay in the process of assembly.
For turning the Chair and to prevent damage to the Chair, 02 persons
may be needed to execute this action.

Assembly Preparation

Before Beginning Assembly:

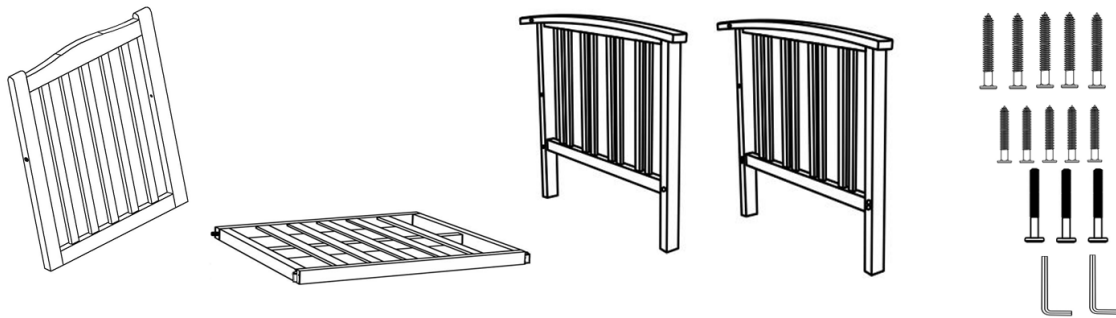

- Read instructions, cover to cover-



- Have 2 adults on hand for assembly-



- Do not assemble on flooring or carpet-





- Assemble on a clean non-marring surface (packing foam)-





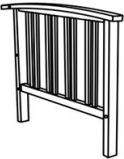

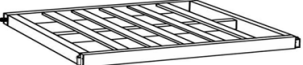
- Save all packaging until finished-

Parts List

No.	Picture	Description	Qty
A		Backrest Panel	1
B1		Right Arm with Leg Panel	1
B2		Left Arm with Leg Panel	1
C		Seat Panel	1

Hardware

No.	Picture	Description	Qty
①		Screw (M7*70mm)	5
②		Screw (M7*60mm)	5
③		Bolt (M6*70mm)	3
④		Allen Key	2

Assembly Steps

OVER VIEW

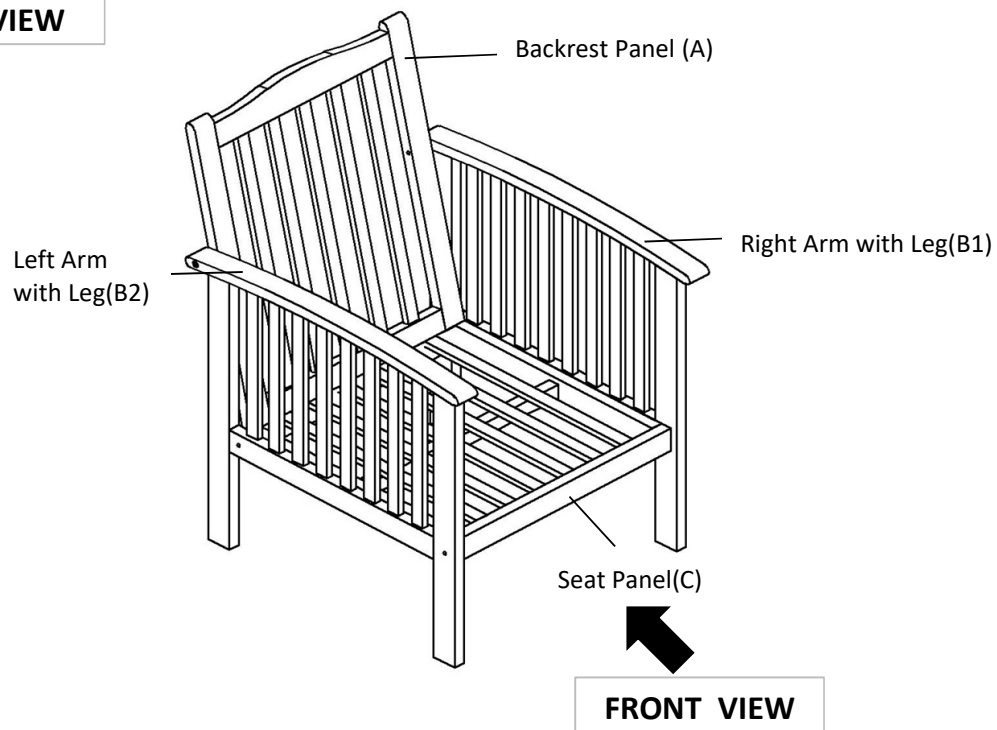

This Chair has multiple parts and may require up to some 30 minutes to assemble. To give you an overview of the Chair, the above picture is to help you put the various parts into perspective. Please read through the instructions here below to familiarise the parts and steps before assembly.

Step 1

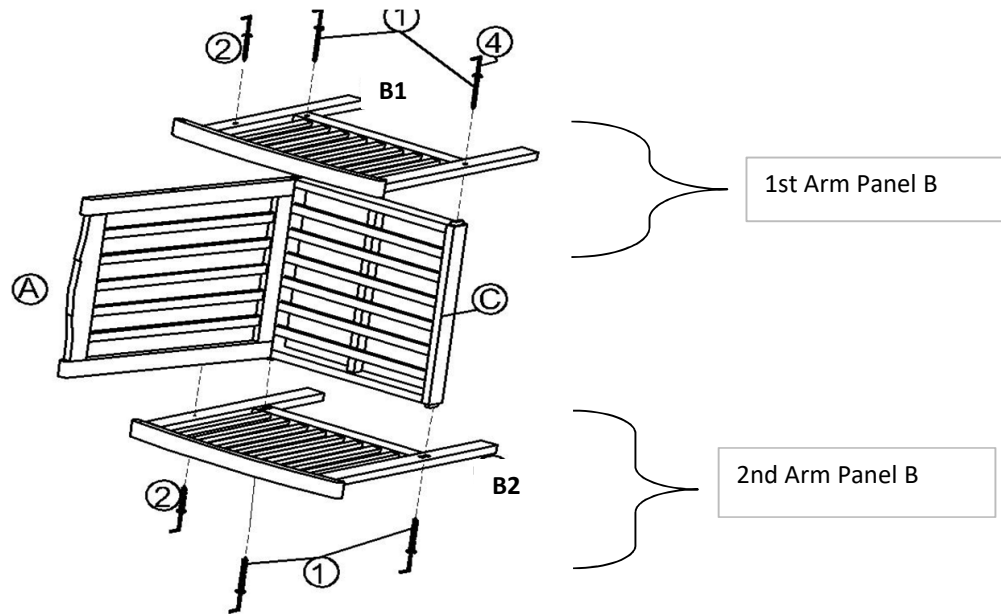

The best place to assemble this Armchair is on a flat surface, eg., floor.
Position Parts Backrest (A) and Seat Panel (C) as shown in picture above.

Affix 1st Right Arm Panel (B1) (facing skywards), as shown above.

Attach Arm Panel(B1) and Backrest Panel(A) by using 1 Screw(2)+Allen Key(4)

Attach Arm Panel(B1) and Seat Panel(C) by using 2 Screws(1)+Allen Key(4)

Then, flip chair to rest on 1st Arm(B1) so that 2nd Arm (B2) is now facing skywards.
Repeat the same process by affixing Screws to designated points.

CAUTION: DO NOT TIGHTEN SCREWS

Step 2

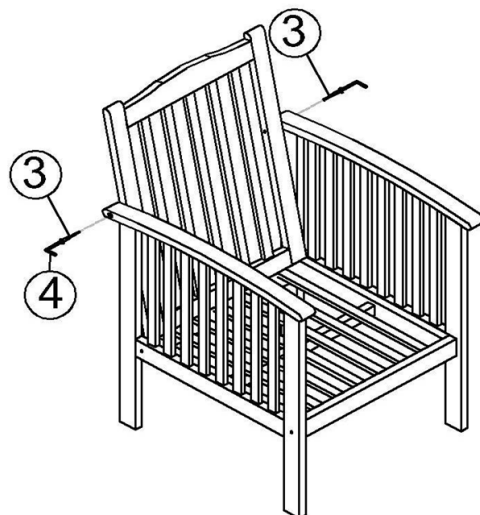

Use Bolt (3) with Allen Key (4) to affix the top of the Backrest to the Armrests on both sides as shown.

DO NOT TIGHTEN BOLTS

Step 3

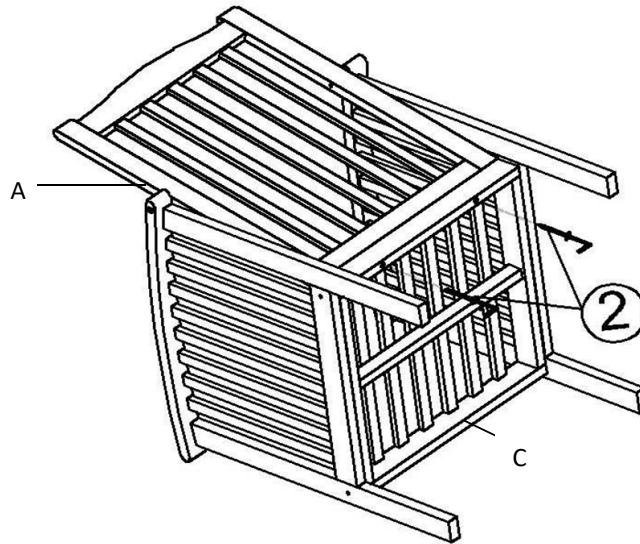

BACK VIEW OF CHAIR.





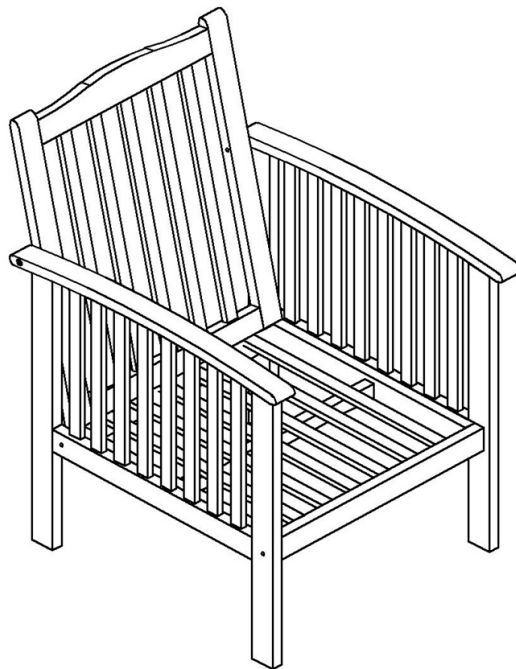



Use Screw (②) and Allen Key (④) to attach Backrest Panel(A) and Seat Panel(C).
DO NOT TIGHTEN SCREWS

Step 4



Turn the Chair right side up.
Inspect it and make sure all parts are adequately connected.
Ensure all bolts and screws are fully locked into position and secured.
The Chair is ready to be used.
This Chair can only be used on a flat, level surface.

Care & Maintenance

- ⊗  ● Do not put hot items directly on furniture surface.
- ⊗  ● Do not clean furniture with harsh cleansers or polish.
- ✓  ● To obtain the longest lifespan of your outdoor products, minimizing exposure to direct sunlight is recommended.
- ⊗  ● Children should not climb or jump on the furniture.
- ⊗  ● Do not write on furniture without a padded barrier to protect the surface.
- ✓  ● To obtain the longest lifespan of your outdoor products, avoid extended and lengthy exposure to rain, snow, and direct sunshine. Whenever possible cover the product and /or place under patio or awnings.
- ⊗  ● Not for commercial use. For residential use only.
- ⊗  ● Stains may be removed with mild soap solution and damp cloth.
- ✓  ● Dust and pick-up spills using a clean, non-colored, lint-free cloth .

Questions & Answers about Proposition 65

- What is Proposition 65?

Proposition 65 requires businesses to provide warnings to Californians about significant exposures to chemicals that cause cancer, birth defects or other reproductive harm. These chemicals can be in the products that Californians purchase, in their homes or workplaces, or that are released into the environment. By requiring that this information be provided, Proposition 65 enables Californians to make informed decisions about their exposures to these chemicals.

Proposition 65 also prohibits California businesses from knowingly discharging significant amounts of listed chemicals into sources of drinking water.

Proposition 65 requires California to publish a list of chemicals known to cause cancer, birth defects or other reproductive harm. This list, which must be updated at least once a year, has grown to include approximately 900 chemicals since it was first published in 1987.

- What types of chemicals are on the Proposition 65 list?

The list contains a wide range of naturally occurring and synthetic chemicals that include additives or ingredients in pesticides, common household products, food, drugs, dyes, or solvents. Listed chemicals may also be used in manufacturing and construction, or they may be byproducts of chemical processes, such as motor vehicle exhaust.

- What does a warning mean?

If a warning is placed on a product label or posted or distributed at a workplace, a business, or in rental housing, the business issuing the warning is aware or believes that it is exposing individuals to one or more listed chemicals.

By law, a warning must be given for listed chemicals unless the exposure is low enough to pose no significant risk of cancer or is significantly below levels observed to cause birth defects or other reproductive harm.

- Where can I get more information on Proposition 65?

If you have specific questions on the administration or implementation of Proposition 65, you can contact OEHHA's Proposition 65 program at P65.Questions@oehha.ca.gov, or by phone at (916) 445-6900.]