

# VISSANI™

SKU #1007086610  
1007086611  
Model #VWA06  
VWA10

## USE AND CARE GUIDE

---

### WINDOW AIR CONDITIONER

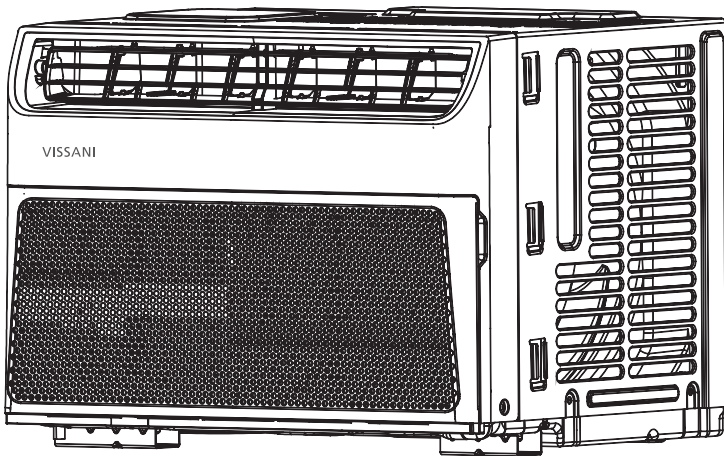

Questions, problems, missing parts? Before returning to the store,  
call Vissani Customer Service  
8 a.m. - 7 p.m., EST, Monday - Friday, 9 a.m. - 6 p.m., EST, Saturday

1-855-847-7264

[HOMEDEPOT.COM](http://HOMEDEPOT.COM)

---

#### THANK YOU

*We appreciate the trust and confidence you have placed in Vissani through the purchase of this air conditioner. We strive to continually create quality products designed to enhance your home. Visit us online to see our full line of products available for your home improvement needs.*

*Thank you for choosing Vissani!*

# Table of Contents

<b>Safety Information</b> .....	3	<b>Care and Cleaning</b> .....	20
Important Safety Instructions .....	3	Cleaning the Air Filter .....	20
Disposing of the Unit .....	3	Cleaning the Front Panel .....	20
Electrical requirements .....	4	Repairing Paint Damage .....	20
Recommended Grounding Method .....	4	Annual Maintenance .....	20
Wiring requirement .....	4	Removing AC From Window .....	20
<b>Pre-Installation</b> .....	4	<b>Troubleshooting</b> .....	21
Power Supply Cord .....	5		
Planning Installation .....	5		
Hardware Included .....	6		
Unpack the Air Conditioner .....	7		
Location Requirements .....	7		
Window Opening Measurements .....	9		
If AC is Blocked by Storm Window .....	9		
<b>Installation</b> .....	10		
ON/OFF Settings .....	14		
<b>Operation</b> .....	14		
Mode Settings .....	15		
Temperature Settings .....	15		
Fan Speeds .....	15		
Timer, Sleep, Filter Functions .....	15		
Wi-Fi .....	16		
Power .....	17		
Fan .....	17		
Mode .....	17		
Temperature .....	17		
Dimmer .....	17		
Sleep .....	17		
Timer .....	18		
Filter .....	18		

# Safety Information

We have provided many important safety messages in this manual and on your appliance. Always read and obey all safety messages.

 **DANGER:** This symbol alerts you to a potential hazard, that if not avoided, will result in death or serious injury.

 **WARNING:** This symbol alerts you to a potential hazard, that if not avoided, could result in death or serious injury.

 **CAUTION:** This symbol alerts you to a potential hazard, that if not avoided, may result in minor or moderate injury.

## IMPORTANT SAFETY INSTRUCTIONS

To reduce the risk of fire, electrical shock or injury when using your air conditioner, follow these basic precautions:

- Plug into a grounded 3-prong outlet.
- Do not remove ground prong.
- Do not use an adapter.
- Do not use an extension cord.
- Unplug air conditioner before servicing.
- Use two or more people to move and install air conditioner.

## DISPOSING OF THE UNIT

- Before throwing out the device, it is necessary to remove the battery cells and dispose or recycle them properly.
- When you need disposal of the unit consult our dealer. If pipes are removed incorrectly, refrigerant may blow out and come into contact with your skin, causing injury. Releasing refrigerant into the atmosphere also damages the environments.
- Please recycle or dispose of the product packaging material in an environmentally responsible manner.
- Never store or ship the air conditioner upside down or sideways to avoid damage to the compressor.
- This appliance is not intended for use by persons (including children) with reduced physical, sensory or mental capabilities, or lack of experience and knowledge, unless they have been given supervision or instruction concerning use of the appliance by a person responsible for their safety. Children should be supervised to ensure that they do not play with the appliance.
- The wiring diagram is shown on nameplate on the air conditioner.

**WARNING:** Risk of Fire or Explosion. This unit contains flammable refrigerant.

Additional safety precautions must be followed.



- Do not use means to accelerate the defrosting process or to clean, other than those recommended by the manufacturer.
- The appliance shall be stored in a room without continuously operating ignition sources (for example: open flames, an operating gas appliance or an operating electric heater).
- Do not pierce or burn refrigerant tubing. Be aware that refrigerants may not contain an odor.
- Keep ventilation openings clear of obstruction.
- The maximum refrigerant charge amount is shown on nameplate on the air conditioner.
- When handling, installing, and operating the appliance, care should be taken to avoid damage to the refrigerant tubing.
- Do not drill holes in the unit.
- Maintenance, cleaning, and service should only be performed by technicians properly trained and qualified in the use of flammable refrigerants.
- Dispose of air conditioner in accordance with Federal and Local Regulations. Flammable refrigerants require special disposal procedures. Contact your local authorities for the environmentally safe disposal of your air conditioner.
- The appliance shall be stored so as to prevent mechanical damage from occurring.

# Pre-Installation

## ELECTRICAL REQUIREMENTS

**WARNING:** Electrical Shock Hazard



- Plug into a grounded 3-prong outlet.
- Do not remove ground prong.
- Do not use an adapter.
- Do not use an extension cord.
- Failure to follow these instructions can result in death, fire, or electrical shock.

## RECOMMENDED GROUNDING METHOD

This air conditioner must be grounded. This air conditioner is equipped with a power supply cord with a three-prong grounding plug. The cord must be plugged into a three-prong outlet, grounded in accordance with all local codes and ordinances. If a grounded outlet is not available, it is the customer's responsibility to have a properly grounded three-prong outlet installed by a qualified electrical installer.

It is the customer's responsibility:

- To contact a qualified electrical installer.
- To assure that the electrical installation is adequate and conforms to the Nation Electrical Code, ANSI/NFPA 70-last edition, and all local codes and ordinances.

Copies of the standards listed may be obtained from:

National Fire Protection Association

1 Batterymarch Park

Quincy, Ma 02169-7471

[www.nfpa.org](http://www.nfpa.org)

## WIRING REQUIREMENT

Power supply	Model	Time-delay fuse (or circuit breaker)
115V 103.5V min. 126.5 V max.	5K BTU DOE 6K BTU DOE	10A
	6K BTU E-star 8K BTU cooling only	13A
	10K BTU cooling only 12K BTU cooling only 14K BTU cooling only 8K BTU cooling and heating	15A

## Pre-Installation (continued)

### POWER SUPPLY CORD

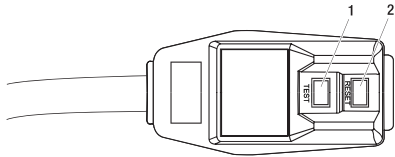

**NOTE:** Your air conditioner's device may differ from the one shown. This room air conditioner is equipped with a power supply cord required by UL. This power supply cord contains state-of-the-art electronics that sense leakage current. If the cord is crushed, the electronics detect leakage current and power will be disconnected in a fraction of a second.

To test your power supply cord:

1. Plug power supply cord into a grounded 3-prong outlet.
2. Press RESET (2) (on some devices, a green light will turn on).
3. Press TEST (1) and listen for click. The RESET button will trip and on some devices, a green light will turn off.
4. Press and release RESET (2) and listen for click. The RESET button will latch, and on some devices, a green light will turn on. The power supply cord is ready for operation.

**NOTE:** The RESET button must be pushed in for proper operation.



- The power supply cord must be replaced if it fails to trip when the test button is pressed or fails to reset.
- Do not use the power supply cord as an off/on switch. The power supply cord is designed as a protective device.
- A damaged power supply cord must be replaced with a new power supply cord obtained from the product manufacturer and must not be repaired.
- The power supply cord contains no user serviceable parts. Opening the tamper-resistant case voids all warranty and performance claims.

### PLANNING INSTALLATION

Gather the required tools and parts before starting installation. Read and follow the instructions provided with any tools listed here.

#### TOOLS REQUIRED

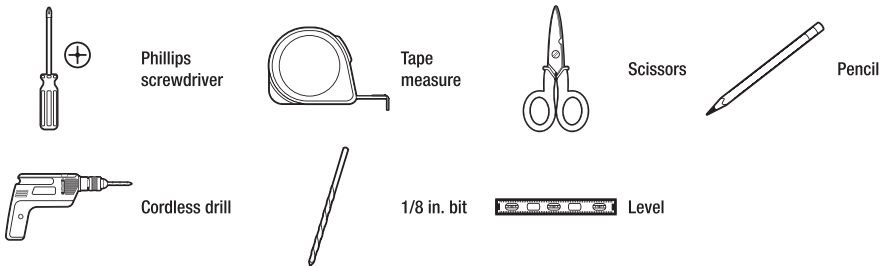

# Pre-Installation (continued)

## HARDWARE INCLUDED



**NOTE:** Check that all parts are included in parts package.

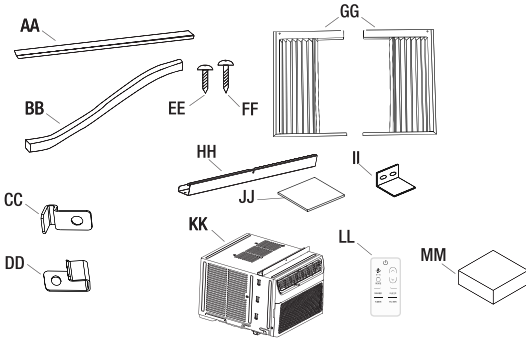

Part	Description	Quantity
AA	Adhesive seal	2
BB	Foam seal	1
CC	Lock frame (for wooden windows)	2
DD	Lock frame (for vinyl-clad windows)	2
EE	3/8 inch screws	4
FF	3/4 inch screws	7
GG	Side curtains	2
HH	Top rail	1
II	Sash lock	1
JJ	EVA foam	2
KK	Air conditioner	1
LL	Remote control	1
MM	Sealing sponge	1

**NOTE:** For certain models, top rail (HH) and 3/8 inch screws (EE) had been attached by manufacturer.



The EVA foam (JJ) is provided only for E-star models, with E-star LOGO on the control panel.

The sealing sponge (MM) is provided only for 5K/6K BTU DOE models.

# Pre-Installation (continued)

## UNPACK THE AIR CONDITIONER

**WARNING:** Excessive Weight Hazard



Use two or more people to move and install air conditioner.

Failure to do so can result in back or other injury.

### Remove packaging materials

- Remove and dispose of/recycle packaging materials. Remove tape and glue residue from surfaces before turning on the air conditioner. Rub a small amount of liquid dish soap over the adhesive with your fingers. Wipe with warm water and dry.
- Do not use sharp instruments, rubbing alcohol, flammable fluids, or abrasive cleaners to remove tape or glue. These products can damage the surface of your air conditioner.
- Handle the air conditioner gently.
- Remove top rail (HH) from the packaging material (A).

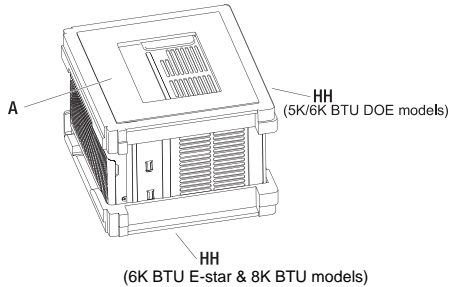

## LOCATION REQUIREMENTS

### Before you Begin

Read these instructions completely and carefully.

#### IMPORTANT:



- Save these instructions for local inspector's use.
- Observe all governing codes and ordinances.



**NOTE:** Installer, be sure to leave these instructions with the Consumer.



**NOTE:** Consumer, keep these instructions for future reference.

- Skill level: Installation of this appliance requires basic mechanical skills.
- Completion time: Approximately 1 hour.
- We recommend that two people install this product.

## Pre-Installation (continued)

- Proper installation is the responsibility of the installer.
- Product failure due to improper installation is not covered under the warranty.
- You **MUST** use all supplied parts and use proper installation procedures as described in these instructions when installing this air conditioner.



**IMPORTANT:** Observe all governing codes and ordinances.

Check the location where air conditioner will be installed. Proper installation is your responsibility. Make sure you have everything necessary for correct installation.

The location should provide:

- Do not use an extension cord. The appliance shall be installed in accordance with national wiring regulations.
- Free movement of air in room to be cooled.
- A large enough opening for the air conditioner.



**NOTE:** Cabinet louvers (A) must not be obstructed. Air must be able to pass freely through the cabinet louvers. Cooling and heating units do not have top louvers.

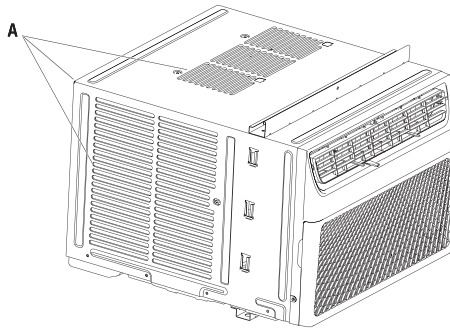



# Pre-Installation (continued)

## WINDOW OPENING MEASUREMENTS

- These instructions are for a standard double-hung window. You will need to modify them for other types of windows.
- The air conditioner can be installed without the side curtain panels if needed to fit in a narrow window. See the window opening dimensions.
- All supporting parts must be secured to firm wood, masonry or metal.
- The electrical outlet must be within reach of the power cord.
- Follow the dimensions in the table and illustration for your model.

Models	A	B
5K BTU DOE 6K BTU DOE	12 2/5 inch (315 mm) min	22 inch (559 mm) - 37 4/5 inch (960 mm)
6K BTU E-star 8K BTU	13 3/5 inch (345 mm) min	24 1/2 inch (622 mm) - 39 inch (991 mm)
10K BTU 12K BTU 14K BTU	15 1/5 inch (386 mm) min	24 9/10 inch (632 mm) - 39 inch (991 mm)

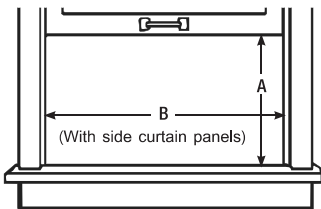

## IF AC IS BLOCKED BY STORM WINDOW

Add wood as shown, or remove storm window before air conditioner is installed.

If storm window frame must remain, be sure the drain holes or slots are not caulked or painted shut. Accumulated rain water or condensation must be allowed to drain out.

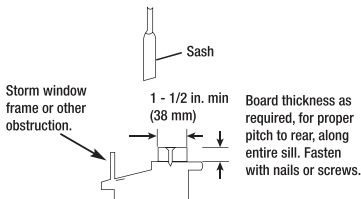

# Installation

## 1 Attaching the Top Rail



**NOTE:** For certain models, top rail had been attached by manufacturer.

- Locate the bag of screws provided.
- Place the top rail (B) on top of the air conditioner cabinet, lining up the 4 holes in the top rail with the 4 holes on top of the air conditioner cabinet.
- Using four 3/8 inch (10 mm) screws (A), attach the top rail (B) to the air conditioner cabinet.

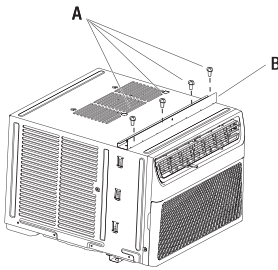

**NOTE:** Attach side curtains to the air conditioner before placing the air conditioner in window.

- Insert top and then bottom of right-hand curtain housing (A) in top and bottom curtain rails (B) on air conditioner.

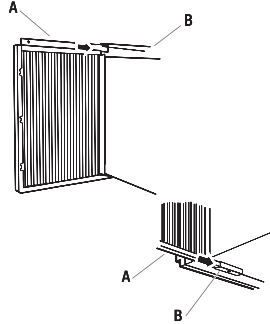

- Slide the curtain housing into the channels as far as it will go.
- Repeat above steps for the left-hand curtain.

## 2 Installing the Side Curtains



**NOTE:** Attach curtains to the air conditioner before placing the air conditioner in window.

- Slide the side curtain (GG) directly into the cabinet (B).
- Slide the side curtain (GG) down.

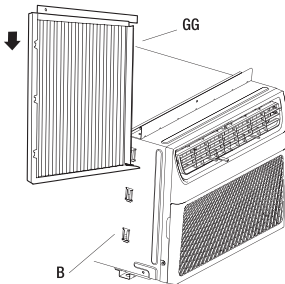

## 3 Attaching the Adhesive Seal

- Cut the adhesive seal to the width of the lower window sash.
- Remove the backing from the seal and attach the seal to the bottom of the lower window sash.

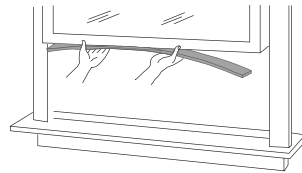

## Installation (continued)

### 4 Placing Air Conditioner in Window



**WARNING: Excessive Weight Hazard**

- Use two or more people to move and install air conditioner.
- Failure to do so can result in back or other injury.

**NOTES:**



- Handle air conditioner gently.
- Be sure your air conditioner does not fall out of the opening during installation or removal.
- Do not block the louvers in the front panel.
- Do not block the louvers on the outside of the air conditioner.
- Your model may differ from the one shown.

- Center air conditioner in window. Lower the window sash behind the top rail to hold cabinet in place.
- Keeping a firm grip on the air conditioner, carefully place the unit into the window opening so the bottom of the air conditioner frame is against the window sill and make sure the unit is staying center of the window.
- Carefully close the window behind the top rail of the unit.

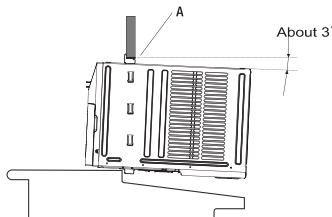

- Place the frame lock between the frame extensions and the window sill with 3/4 inch (19 mm) screw as shown.

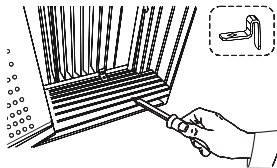

- To secure lower sash in place, attach right angle sash lock with 3/4 inch (19 mm) screw as shown.

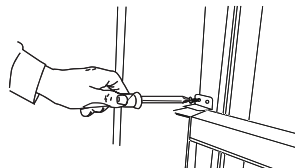

## Installation (continued)

### 5 Attaching Side Curtains to Window

- Pull the left-hand curtain out until it fits into the window channel.
- Use a 1/8 inch (3 mm) drill bit to drill a starter hole through the hole in the top rail.
- Insert one of the 3/4 inch (19 mm) screws (C) through the left-hand curtain (B) and into the window sash (A).

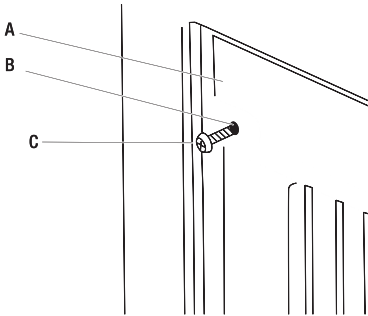

**NOTE:** The remaining steps on this page are only applicable for E-star models with E-star LOGO on the control panel.

- Put one EVA foam (JJ) on the curtain housing.
- In order to minimize air leaks and ensure optimal insulation, it is necessary to install the EVA Fo foam (JJ) am on the curtain housing.
- After the unit is installed to the window, measure the inner width of the side curtain as shown.

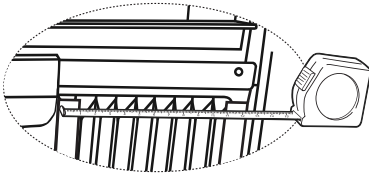

- Remark a line on the EVA foam (JJ) according to less 1/8 inch (3 mm) than the measured width in, then cut the EVA foam (JJ) along the line.

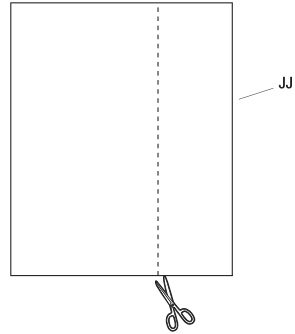

- Remove the backing from the EVA foam (JJ). Attach one EVA foam (JJ) on the curtain housing (A), the side with adhesive should facing the curtain housing.

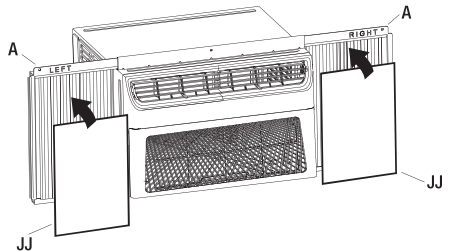

- Repeat for the right-hand curtain.

## Installation (continued)

### 6 Completing Installation

- Insert foam seal (B) behind the top of the lower window sash (A) and against the glass of the upper window.



- Use a 1/8 inch (3 mm) drill bit to drill a starter hole through the hole in the top rail.
- Attach top channel to window sash with one 3/4 inch (19 mm) screw to secure window in place.

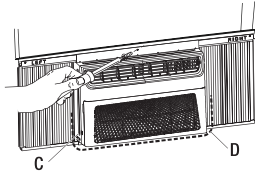

- The sealing sponge (C) is provided only for 5K/6K BTU DOE models.
- Check the gap (D) around the unit and seal it with the adhesive seal attached.

#### **DANGER: ELECTRICAL SHOCK HAZARD**



- Plug into a grounded 3-prong outlet.
- Do not remove ground prong.
- Do not use an adapter.
- Do not use an extension cord.
- Failure to follow these instructions can result in death, fire, or electrical shock.

- Plug into a grounded 3-prong outlet.
- Press RESET on the power supply cord. See "Electrical Requirements".

# Operation

## AIR CONDITIONER USE

### IMPORTANT:

-  If you turn off the air conditioner, wait at least 3 minutes before turning it back on. This prevents the air conditioner from blowing a fuse or tripping a circuit breaker.
- Air conditioner in the Cool mode operation the better limits: Outdoor 64.4-109.4°F (18-43 °C), 80% RH; indoor 62.6-89.6°F (17-32°C), 80% RH.

- Operating your air conditioner properly helps you to obtain the best possible results.
- This section explains proper air conditioner operation.

## 1 Using the Control Panel



ON/OFF

### ON/OFF SETTINGS

- Press the power button to turn on the air conditioner.



**NOTE:** When the air conditioner is turned on for the first time after it is plugged in, the display will show the current set temperature and will run in the ECO control.

After cleaning and replacing the filter, press the POWER button for resetting and the FILTER light will go off.

- Select mode. See “Mode Settings” on page 15.
- Set temperature. See “Temperature Settings” on page 15.
- Select fan speed. See “Temperature Settings” on page 15.

# Operation (continued)

• Fan • Dry • Cool • Eco • Heat



MODE

## MODE SETTINGS

- Press MODE repeatedly until you see the indicator light glow for the desired setting.
- Choose Fan, Dry, Cool, Eco.
- FAN - To select Fan Only mode.
- Dry - Dries the room. The air conditioner automatically selects the temperature. Fan runs at Low speed only.
- Cool - Cools the room.
- Eco - Cools the room and saves energy.
- Heat - Heats the room.







### NOTE:

- Heat is available only for heating models.
- Dry mode should not be used to cool the room.

- For E-star models, the fan will continue to run after the compressor shuts off for 2 minutes (4 minutes for the first time), then the fan will shut off for 10 minutes. The fan then cycles for intervals of 2 minutes on and 10 minutes off until the room temperature is above the set temperature, at which time the compressor turns back on and Cooling resumes. Select ECO mode to initiate this function



## TEMPERATURE SETTINGS

- Press the plus UP  button to raise the temperature. Each time you press or hold the plus UP  button, the temperature will go up 1 °F (1 °C) until it reaches 86°F (30°C).
- Press the minus DOWN  button to lower the temperature. Each time you press or hold the DOWN  button, the temperature will go down 1 °F (1 °C) until it reaches 61 °F (16°C).
- To change the temperature display from °F to °C: Press both the MODE and DOWN  buttons at the same time for 5 seconds to switch the display from °F to °C.

• Low • Med • High



FAN

## FAN SPEEDS



**NOTE:** The Fan button will operate only when the Fan, Cool, ECO or Heat mode has been selected.

- Press FAN until you see the indicator light glow for the desired setting.
- Choose High, Med, Low.
- High - for maximum cooling
- Med - for normal cooling
- Low - for quieter cooling



**NOTE:** In ECO mode, the Fan will run at low speed when compressor turns off.

• Timer • Sleep • Filter

## TIMER, SLEEP, FILTER FUNCTIONS

- The LED light on control panel for Timer, Sleep, Filter.
- For function operation, see "Using the Remote Control."

## Operation (continued)



(Optional)

### WI-FI

- Wi-Fi control is available for connected models with this logo on control panel.
- Press the CONNECT button for 5 seconds; the LED starts to flash.
- After the Wi-Fi connects to the router, the LED keeps on or the LED keeps off.



**NOTE:** Wi-Fi control is available only for Wi-Fi control models.

## 2 Using the Remote Control



**NOTE:** Remote control may differ in appearance.

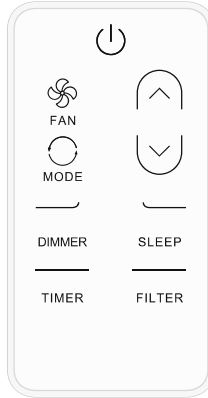

### NOTE:

- At the time of first use, please remove the insulated plastic patch.
- One CR2025 battery (included) powers the remote control. Replace battery after 6 months of use, or when the remote control starts to lose power.
- Please ensure the direction for polarity of the battery is the same as the indicator on the bracket (A).
- Old batteries must be removed and disposed of in accordance with current legislation as they are harmful to the environment.

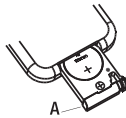



# Operation (continued)



## POWER

- Press power button to turn the air conditioner on/off.



## FAN

- Press FAN to select High, Med, Low.



**NOTE:** In Dry mode, Fan speed cannot be set.







## MODE

- Press MODE to select Fan, Dry, Cool, ECO.



## TEMPERATURE

- Press the plus UP  button to raise the temperature. Each time you press or hold the plus UP  button, the temperature will go up 1°F (1 °C) until it reaches 86°F (30°C).
- Press the minus DOWN  button to lower the temperature. Each time you press or hold the DOWN  button, the temperature will go down 1°F (1°C) until it reaches 61 °F (16°C).

DIMMER

## DIMMER

- Press the DIMMER button to turn off the control panel display.



**NOTE:** When in DIMMER mode, new control inputs will return display to normal.

SLEEP

## SLEEP



**NOTE:** When you press sleep button:

- In the Cooling mode, Dry mode, and ECO mode, the set temperature will increase by 4 °F (2°C) at most, during 2 hours, and continues running at that temperature until auto shut off.
  - In Heating mode, the set temperature will decrease by 4°F (2°C) at most, during 2 hours, and continues running at that temperature until auto shut off.
- Press MODE to select Cool, Dry or ECO.
  - Press FAN to select High, Med or Low.
  - Press the up or down arrow button to set the temperature.
  - Press SLEEP. After 10 seconds, the lights on the control panel display will dim.



**NOTE:** The mode and temperature may be adjusted during Sleep control. Fan speed is automatically set to LOW.

- To turn off Sleep control, press SLEEP again or wait 8 hours for the air conditioner to turn off automatically.



**NOTE:** The air conditioner will return to previous settings after Sleep control is turned off.

## Operation (continued)

### TIMER

#### TIMER

To set timer for a 1-24 hour delay on-off operation:

- Press TIMER on remote control. The LED display on the air conditioner control panel will flash.
- Press up or down arrow button to change the delay time from 1 hour to 24 hours.
- Press TIMER on remote control again for TIMER confirmation and TIMER indicator light on the air conditioner control will be on.
- To cancel the TIMER, press the TIMER on remote and the TIMER indicator light will be off.

### FILTER

#### FILTER

- When the Filter indicator light is lit, remove, clean and replace the air filter. See "Cleaning the Air Filter".
- Press Power button on the machine or FILTER button on remote to reset the filter after cleaning and replacing the air filter.



**NOTE:** When the light is on, it will remain on for 180 hours or until you press Clean Filter button.

## 3 Changing Air Direction

- Use the Vertical Level Vane (A) to direct the air right or left. Use the whole cartridge (B) to direct air up, down or straight ahead.

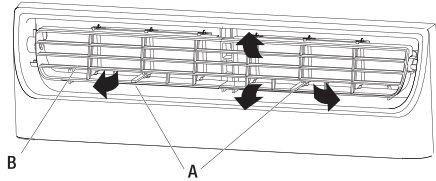

## Operation (continued)

### 4 Exhaust Air Vent

- Pull out the exhaust air vent control to Open the exhaust air vent and draw stale or smoky air from the room.
- Push in the exhaust air vent control to close the exhaust air vent for maximum continuous cooling.



**NOTE:** The exhaust air vent control is available only for 10K\12K\14K models.

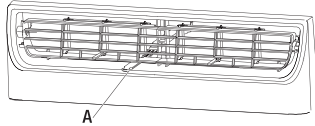

**NOTE:** The exhaust air vent control will function only when the fan is running.

### 5 Normal Sounds

When your air conditioner is operating normally, you may hear sounds such as:

- Droplets of water hitting the condenser, causing a pinging or clicking sound. The water droplets help cool the condenser.
- Air movement from the fan.
- Clicks from the thermostat cycle.
- Vibrations or noise due to poor wall or window construction.
- A high-pitched hum or pulsating noise caused by the modern high-efficiency compressor cycling on and off.

## Care and Cleaning

Your new air conditioner is designed to give you many years of dependable service. This section tells you how to clean and care for your air conditioner properly. Call your local authorized dealer for an annual checkup. Remember the cost of this service call is your responsibility.

### CLEANING THE AIR FILTER

The air filter is removable for easy cleaning. A clean filter helps remove dust, lint, and other particles from the air and is important for best cooling and operating efficiency. Check the filter every 2 weeks to see whether it needs cleaning.



**NOTE:** Do not operate the air conditioner without the filter in place.

- Turn off the air conditioner.
- Open the front panel. Grasp the filter by the handle and pull it out.

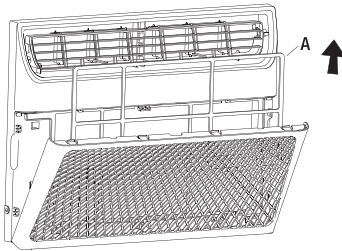

- Use a vacuum cleaner to clean the air filter. If the air filter is very dirty, wash it in warm water with a mild detergent. Do not wash the air filter in the dishwasher or use any chemical cleaners. Air dry the filter completely before replacing to ensure maximum efficiency.
- Replace the air filter back into the air conditioner.

### CLEANING THE FRONT PANEL

- Turn off the air conditioner.
- Clean the front panel with a soft, damp cloth.
- Air dry the front panel completely.

### REPAIRING PAINT DAMAGE

Check once or twice a year for paint damage. This is very important, especially in areas near oceans or where rust is a problem. If needed, touch up with a good grade enamel paint.



### ANNUAL MAINTENANCE

Your air conditioner needs annual maintenance to help ensure steady, top performance throughout the year. Call your local authorized dealer to schedule an annual checkup. The expense of an annual inspection is your responsibility.

### REMOVING AC FROM WINDOW

- Turn AC off, and disconnect power cord.
- Remove sash seal from between windows and unscrew safety lock.
- Remove screws installed through frame and frame lock. Remove the EVA foam (E-star models only).
- Close the curtain housing.
- Keeping a firm grip on air conditioner, raise sash and carefully remove.
- Be careful not to spill any standing water while lifting unit from window. Store parts with the AC.

# Troubleshooting

Problem	Solution
Air conditioner will not operate	<p><b>DANGER: ELECTRICAL SHOCK HAZARD</b></p> <ul style="list-style-type: none"> <li><input type="checkbox"/> Plug into a grounded 3-prong outlet.</li> <li><input type="checkbox"/> Do not remove ground prong.</li> <li><input type="checkbox"/> Do not use an adapter.</li> <li><input type="checkbox"/> Do not use an extension cord.</li> <li><input type="checkbox"/> Failure to follow these instructions can result in death, fire, or electrical shock.</li> </ul>  <ul style="list-style-type: none"> <li><input type="checkbox"/> The power supply cord is unplugged. Plug into grounded 3-prong outlet. See “Electrical Requirements”.</li> <li><input type="checkbox"/> The power supply cord has tripped (RESET button has popped out). Press and release RESET to resume operation.</li> <li><input type="checkbox"/> A household fuse has blown, or circuit breaker has tripped. Replace the fuse or reset the circuit breaker. If the problem continues, call an electrician. See “Electrical Requirements”.</li> <li><input type="checkbox"/> The Power button has not been pressed. Press the Power button.</li> <li><input type="checkbox"/> The local power has failed. Wait for power to be restored.</li> </ul>
Air conditioner blows fuses or trips circuit breakers	<ul style="list-style-type: none"> <li><input type="checkbox"/> Too many appliances are being used on the same circuit. Unplug or relocate appliances that share the same circuit.</li> <li><input type="checkbox"/> Time-delay fuse or circuit breaker of the wrong capacity is being used. Replace with a time-delay fuse or circuit breaker of the correct capacity. See “Electrical Requirements”.</li> <li><input type="checkbox"/> An extension cord is being used. Do not use an extension cord with this or any other appliance.</li> <li><input type="checkbox"/> You are trying to restart the air conditioner too soon after turning off the air conditioner. Wait at least 3 minutes after turning off the air conditioner before trying to restart the air conditioner.</li> </ul>
Air conditioner power supply cord trips (Reset button pops out)	<ul style="list-style-type: none"> <li><input type="checkbox"/> Disturbances in your electrical current can trip (RESET button will pop out) the power supply cord. Press and release RESET to resume operation.</li> <li><input type="checkbox"/> Electrical overloading, overheating, cord pinching or aging can trip (RESET button will pop out) the power supply cord. After correcting the problem, press and release RESET to resume operation.</li> </ul> <div style="border: 1px solid black; padding: 5px;">  <p><b>NOTE:</b> A damaged power supply cord must be replaced with a new power supply cord obtained from the product manufacturer and must not be repaired.</p> </div>

## Troubleshooting (continued)

Problem	Solution
Air conditioner seems to run too much	<ul style="list-style-type: none"> <li>□ The current air conditioner replaced an older model. The use of more efficient components may cause the air conditioner to run longer than an older model, but the total energy consumption will be less. Newer air conditioners do not emit the “blast” of cold air you may be accustomed to from older air conditioners, but this is not an indication of lesser cooling capacity or efficiency. Refer to the efficiency rating (EER) and capacity rating (in Btu/h) marked on the air conditioner.</li> <li>□ The air conditioner is in a heavily occupied room, or heat producing appliances are in use in the room. Use exhaust vent fans while cooking or bathing and try not to use heat producing appliances during the hottest part of the day. A higher capacity air conditioner may be required, depending on the size of the room being cooled.</li> </ul>
Air conditioner cycles on and off too much or does not cool	<ul style="list-style-type: none"> <li>□ The air conditioner is not properly sized for your room. Check the cooling capabilities of your room air conditioner. Room air conditioners are not designed to cool multiple rooms.</li> <li>□ The filter is dirty or obstructed by debris. Clean the filter.</li> <li>□ The inside evaporator and outside condenser coils are dirty or obstructed by debris. See Annual Maintenance.</li> <li>□ There is excessive heat or moisture (open container cooking, showers, etc.) in the room. Use a fan to exhaust heat or moisture from the room. Try not to use heat producing appliances during the hottest part of the day.</li> <li>□ The louvers are blocked. Install the air conditioner in a location where the louvers are free from curtains, blinds, furniture, etc.</li> <li>□ The temperature of the room you are trying to cool is extremely hot. Allow extra time for the air conditioner to cool off a very hot room.</li> <li>□ Windows or doors to the outside are open. Close all windows and doors.</li> <li>□ The Temp control is not at a cool enough setting. Adjust the Temp control to a cooler setting by pressing the minus button to reduce the temperature. Set the Fan Speed control to the highest setting.</li> </ul>
Water drips from cabinet into your house	<ul style="list-style-type: none"> <li>□ The air conditioner is not properly leveled. The air conditioner should slope slightly downward toward the outside. Level the air conditioner to provide a downward slope toward the outside to ensure proper drainage. See the Installation Instructions.</li> </ul> <div style="border: 1px solid black; padding: 5px; margin-top: 10px;">  <p><b>NOTE:</b> Do not drill a hole in the bottom of the metal base and condensate pan.</p> </div>



# VISSANI™

Questions, problems, missing parts? Before returning to the store,  
call Vissani Customer Service  
8 a.m. - 7 p.m., EST, Monday - Friday, 9 a.m. - 6 p.m., EST, Saturday

**1-855-847-7264**

**HOMEDEPOT.COM**

Retain this manual for future use.

4238139-01