



NEW
COLORS
AVAILABLE

RUSTIC MAHOGANY TYPE



CONTEMPORARY



CRAFTSMAN



MAHOGANY TYPE



AMERICAN RED OAK



DUTCH DOOR



PLATINUM

2020-2021 EXTERIOR & INTERIOR DOOR CATALOG

UP TO 4 WEEK PRODUCTION TIME

OUR HISTORY



In 1996 Main Door was founded with the basic philosophy to offer the best quality solid wood entry door (no veneer) combined with the best customer service possible. Our home office, showroom, manufacturing facility and warehouse are located in Los Angeles, California.

We are committed to the protection of the environment through proper forest management. Our product line is shipped directly from state-of-the-art manufacturing facilities that responsibly harvest the lumber in accordance with FSC® standards. Our close relationship with these manufacturers enables us to offer top-of-the-line green products that are priced below the competition.

Main Door is proudly FSC® certified by NEPCo, a partner of the Rainforest Alliance. We are also certified by NAMI's NFRC 11-step certification program on door performance testing.



The mark of
responsible forestry



HOW TO ORDER

Place your Order
and choose from
additional options at
your nearest
Home Depot store



Speak to an associate
Millwork (Dept #30)
Vendor #19532



Choose your
Door Collection



Select your door
configuration style



Pick your favorite
door design

OUR COLLECTIONS

- Rustic Mahogany Type 3
- Rustic Mahogany Type Interior 7
- Mahogany Type 9
- Mahogany Type Interior 13
- Contemporary Mahogany Type 15
- Craftsman Mahogany Type 21
- Dutch Mahogany Type 25
- Rustic Platinum Teak 27
- American Red Oak 29

PRODUCT INFO

- Door Specifications 32
- Prehung Construction 32
- Glass Options 33
- Hardware, Sills & Mouldings 33
- Custom Solutions 34
- Standard Glass Options 35
- Important Considerations 37
- Availability & Specifications 38



Choose your stain or paint color



Select your glass options (if any)





ABOUT THE COLLECTION

Main Door Corporation's signature Rustic finish is a unique 12-step process individually applied to each door to create unique entry pieces.

- 100% Solid Wood No Veneers
- Operable speakeasy with weather stripping
- Textured handcrafted hardware and accessories options
- Custom sizes to fit most openings

FINISHES



Rustic Finish



White Paint

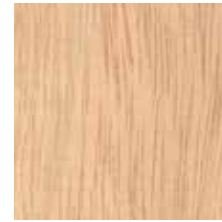

Unfinished

(Color samples available to store upon request)

RUSTIC FINISH OPTIONS

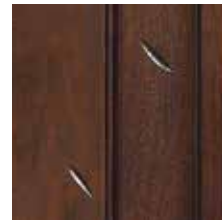

Distress Marks



Black Edges

(Available in Rustic Finish only)

RUSTIC GLASS



Rain



Patina



Wrought Iron



Clear



Opaque



MODELS



SH-900 FULL LITE
 36"W x 80"H | Rustic Finish
 Wrought Iron Glass C
 Round Brackets



SH-901 FULL PANEL
 36"W x 80"H | Rustic Finish
 Black Patina Glass B
 Square Brackets



SH-902 TWO PANEL
 36"W x 80"H | White
 Rain Glass A



SH-903 FULL PANEL V-GROOVE
 36"W x 80"H | White
 Rain Glass A



SH-904* TWO PANEL V-GROOVE
 30"W, 32"W x 80"H | Rustic Finish
 36"W, 42"W x 80"H | Clear Glass
 36"W x 96"H | Square Clavos
 Single 36x80" 904 Prehung available nation-
 wide online and as a stock item in select stores



SH-914 TWO PANEL V-GROOVE ARCH TOP
 30"W, 32"W x 80"H | White
 36"W x 80"H | Black Patina Glass B
 Round Clavos

DECORATIVE RUSTIC HARDWARE

Our Rustic doors can be configured with an array of decorative rustic hardware. A functional speakeasy allows you to see who's at the door. Wrought iron grilles adorn and add protection to the glass in Rustic sidelites. Round or square corner brackets and clavos (decorative nails) can be added to both sides of your entry door. (decorative upgrades at additional charge)



Operable Speakeasy Door with Wrought Iron Grill



Round & Square Clavos

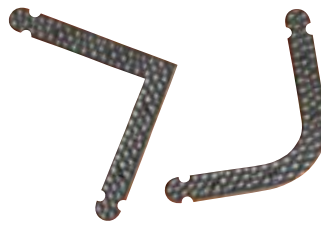

Round & Square Corner Brackets



Wrought Iron Grill (For Sidelite Only)

RUSTIC SIDELITE OPTIONS



1 FULL SIDELITE GLASS C

SH-900
SH-901
SH-903



2 3/4 SIDELITE GLASS A

SH-902



3 FULL SIDELITE GLASS B

SH-900
SH-901
SH-903



4 3/4 SIDELITE GLASS B

SH-904



5 FULL SIDELITE CLEAR GLASS GRILL

SH-900
SH-901
SH-903



6 3/4 SIDELITE WOOD PANEL

SH-900
SH-901
SH-902
SH-903
SH-904



RUSTIC TRANSOM OPTIONS

For grand entrances transom options are an ideal solution. Functional and decorative, our transoms allow extra light to enter the home while adding a distinctive touch to your home's decor.



SH-900: Rustic Finish, Glass C



Half Round Wrought Iron, Glue Chip Glass C



Elliptical Wrought Iron, Glue Chip Glass C



Rectangular Dual Clear



Rectangular Rain Glass, Glass A

AVAILABLE TRANSOM SIZES

	A - Rain Glass	B - Black Patina Glass	C - Wrought Iron Glass	Dual - Clear/Opaque Glass
HALF ROUND	N/A	N/A	61" W x 31-1/4" H or 73" W x 37-1/4" H	N/A
ELLIPTICAL	N/A	N/A	61" W x 16" H or 73" W x 16" H	N/A
RECTANGULAR	38-1/2" W min - 69-5/8" W max 12-1/2" H min - 17-1/2" H max	N/A	69-5/8" W min - 91" W max 12-1/2" H min - 17-1/2" H max	38-1/2" W min - 91" W max 12-1/2" H min - 17-1/2" H max



ABOUT THE COLLECTION

Our matching Interior Rustic Mahogany type doors are the perfect complement to your rustic entryway. Single and Double Prehung units and Slab Doors available in 4 different panel styles.

- 100% Solid Wood No Veneers
- Handcrafted hardware accessories now available
- Distressed finish for a distinctive look
- Custom sizes to fit most openings

FINISHES



Rustic Finish



White Paint



Unfinished

(Color samples available to store upon request)

FINISH OPTIONS

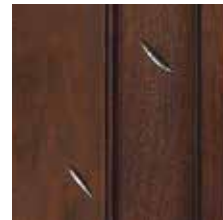

Distress Marks



Black Edges

ACCESSORIES



Round Clavos



Square Clavos

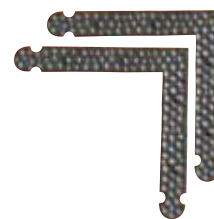

Square Brackets

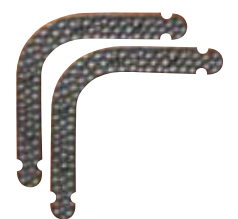

Round Brackets



MODELS



SH-9210 RUSTIC TWO PANEL
Rustic Finish
24"W x 80"H
28"W x 80"H
30"W x 80"H
32"W x 80"H
36"W x 80"H



SH-9220 RUSTIC TWO PANEL V-GROOVE
White
24"W x 80"H
28"W x 80"H
30"W x 80"H
32"W x 80"H
36"W x 80"H



SH-9230 RUSTIC TWO PANEL ARCH TOP
Rustic Finish
24"W x 80"H
28"W x 80"H
30"W x 80"H
32"W x 80"H
36"W x 80"H



SH-9240 RUSTIC TWO PANEL V-GROOVE ARCH TOP
White
Round Clavos
Round Brackets
24"W x 80"H
28"W x 80"H
30"W x 80"H
32"W x 80"H
36"W x 80"H



SH-9210 RUSTIC TWO PANEL
White
Square Clavos
Square Brackets
24"W x 80"H
28"W x 80"H
30"W x 80"H
32"W x 80"H
36"W x 80"H



SH-9220 RUSTIC TWO PANEL V-GROOVE
Rustic Finish
Round Clavos
24"W x 80"H
28"W x 80"H
30"W x 80"H
32"W x 80"H
36"W x 80"H

CUSHION CLOSE Q-LON

As a unique feature Main Door Mahogany Type Interior Doors use premium sealed door frames. These airtight seals add noise insulation, shock absorption and dust control.

All solid Mahogany type frames are custom built and can be ordered sized 4" to 7-1/2" in width to match the door finish.

Unfinished or finished trims available at additional cost.





ABOUT THE COLLECTION

Our Mahogany Type collection is manufactured with a durable and solid hardwood. This hardwood is valued for its rich grain, adding warmth and style to any home.

- 100% Solid Wood No Veneers
- Classic exterior raised mouldings
- Several glass options including privacy
- Custom sizes to fit most openings

FINISHES



Cherry Stain



Walnut Stain



Golden Oak Stain



Espresso Stain



Antique Stain



Unfinished



Blue Paint*



Red Paint*



Green Paint*



Grey Paint*



Desert Sand Wash Stain



Bright Orange Paint



Lime Green Paint



White Paint

* Semi-transparent paint
(Color samples available to store upon request)

GLASS CAMING OPTIONS



Black Patina



Brass



Zinc



MODELS



SH - 551 FULL LITE
36"W x 80"H | Walnut
Glass C



SH - 551 FULL LITE
36"W x 80"H | Red
Glass A



SH - 552 DOUBLE ARCH TOP
36"W x 80"H | Lime Green
Glass B



SH - 553 HALF MOON
36"W x 80"H | Espresso
Glass B



SH - 554 STANDARD OVAL
30"W, 32"W x 80"H | Golden Oak
36"W, 42"W x 80"H | Glass A



SH - 555 CENTER ARCH
36"W x 80"H | Blue
36"W x 96"H | Glass B

MODELS



SH-556 3/4 LITE
36"W x 80"H | Grey
Glass B



SH-556 3/4 LITE
36"W x 80"H | Antique
Glass B



SH-557 DELUXE OVAL
36"W x 80"H | White
Glass A



SH-558 LONG OVAL
36"W x 80"H | Green
Glass C

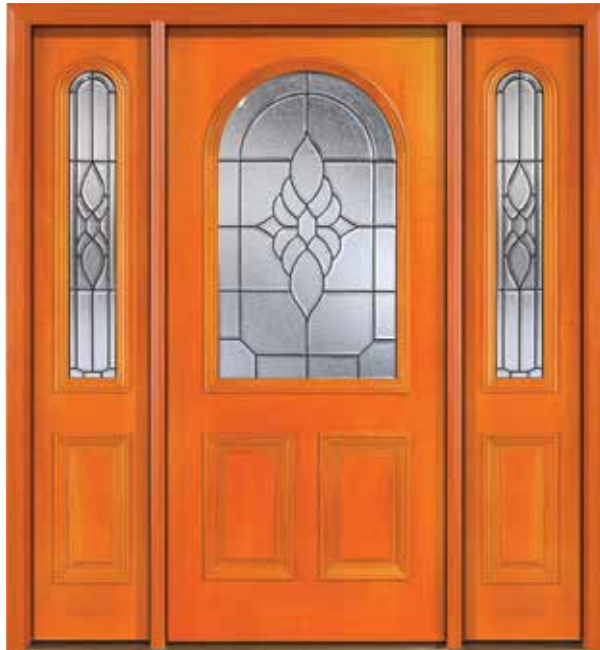

SH-559 3/4 TOP ARCH
36"W x 80"H | Bright Orange
Glass B



SH-600 SIX PANEL
30"W, 32"W x 80"H | Cherry
36"W, 42"W x 80"H | Glass B



MAHOGANY TYPE TRANSM OPTIONS

Our Mahogany Type Collection features 3 different glass styles and 3 unique shapes.



SH-557: Cherry, Glass C



Half Round, Hand Beveled, Full Glue Chip, Glass C



Elliptical, Hand Beveled, Full Glue Chip, Glass C



Rectangular, Hand Beveled, Full Glue Chip, Glass A



Rectangular, Hand Beveled, Full Glue Chip, Glass B



Rectangular, Hand Beveled, Full Glue Chip, Glass C

GLASS CAMING COLOR OPTIONS



Black Patina



Brass



Zinc

AVAILABLE TRANSM SIZES

	A	B	C
HALF ROUND	N/A	N/A	61"W x 31-1/4"W or 73"W x 37-1/4"H
ELLIPTICAL	N/A	N/A	61"W x 16"H or 73"W x 16"H
RECTANGULAR	42-1/2" W min - 107-1/2" W max 12-1/2" H min - 17-1/2" H max	42-1/2" W min - 107-1/2" W max 12-1/2" H min - 17-1/2" H max	42-1/2" W min - 107-1/2" W max 12-1/2" H min - 17-1/2" H max



FINISHES



Cherry Stain



Walnut Stain



Golden Oak Stain



Espresso Stain



Antique Stain



Unfinished



Blue Paint*



Red Paint*



Green Paint*



Grey Paint*



Desert Sand Wash Stain



Bright Orange Paint



Lime Green Paint



White Paint

* Semi-transparent paint
(Color samples available to store upon request)

ABOUT THE COLLECTION

Our matching interior Mahogany type doors are the perfect complement to your grand entryway. Single and Double Prehung units and Slab Doors available in 4 different panel styles.

- 100% Solid Wood No Veneers
- Available in Painted White
- Sealed door stop for soft close and noise reduction
- Custom sizes to fit most openings



MODELS



SH-5210 TWO PANEL

24"W x 80"H | Red
 28"W x 80"H
 30"W x 80"H
 32"W x 80"H
 36"W x 80"H



SH-5220 TWO PANEL V-GROOVE

24"W x 80"H | Antique
 28"W x 80"H
 30"W x 80"H
 32"W x 80"H
 36"W x 80"H



SH-5230 TWO PANEL ARCH TOP

24"W x 80"H | White
 28"W x 80"H
 30"W x 80"H
 32"W x 80"H
 36"W x 80"H



SH-5240 TWO PANEL V-GROOVE ARCH TOP

24"W x 80"H | Blue
 28"W x 80"H
 30"W x 80"H
 32"W x 80"H
 36"W x 80"H



SH-5210 TWO PANEL

24"W x 80"H | Walnut
 28"W x 80"H
 30"W x 80"H
 32"W x 80"H
 36"W x 80"H



SH-5220 TWO PANEL V-GROOVE

24"W x 80"H | Grey
 28"W x 80"H
 30"W x 80"H
 32"W x 80"H
 36"W x 80"H

CUSHION CLOSE Q-LON

As a unique feature Main Door Mahogany Type Interior Doors use premium sealed door frames. These airtight seals add noise insulation, shock absorption and dust control.

All solid Mahogany type frames are custom built and can be ordered sized 4" to 7-1/2" in width to match the door finish.

Unfinished or finished trims available at additional cost.





ABOUT THE COLLECTION

Introduce a touch of modern design with our new Contemporary Solid Wood Door Collection. Updated vibrant colors complement the sleek, yet simple designs to enhance your entryway.

- 100% Solid Wood No Veneers
- Mix and Match Glass or Wood Panel options available
- Vibrant colors adding to the modern look
- Custom sizes to fit most openings

FINISHES



Cherry Stain



Walnut Stain



Golden Oak Stain



Espresso Stain



Antique Stain



Unfinished



Blue Paint*



Red Paint*



Green Paint*



Grey Paint*



Desert Sand Wash Stain



Bright Orange Paint



Lime Green Paint



White Paint

* Semi-transparent paint
(Color samples available to store upon request)

GLASS

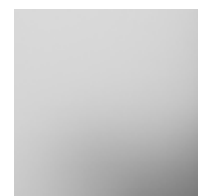

Opaque



MODELS



SH-802 FULL VERTICAL TWO LITE
36"W x 80"H | Blue
Opaque Glass



SH-802 FULL VERTICAL TWO LITE
36"W x 80"H | Red
Opaque Glass
Wood Panel



SH-802 FULL VERTICAL TWO LITE
36"W x 80"H | Golden Oak
Opaque Glass
Wood Panel



SH-803 HORIZONTAL THREE LITE
36"W x 80"H | Grey
Opaque Glass



SH-803 HORIZONTAL THREE LITE
36"W x 80"H | Walnut
Opaque Glass
Wood Panel



SH-803 HORIZONTAL THREE LITE
36"W x 80"H | Green
Opaque Glass

MODELS



SH-805 HORIZONTAL FIVE LITE
36"W x 80"H | Grey
Opaque Glass
Wood Panel



SH-805 HORIZONTAL FIVE LITE
36"W x 80"H | Golden Oak
Opaque Glass



SH-805 HORIZONTAL FIVE LITE
36"W x 80"H | White
Opaque Glass



SH-808 HORIZONTAL EIGHT LITE
36"W x 80"H | Lime Green
Opaque Glass



SH-808 HORIZONTAL EIGHT LITE
36"W x 80"H | Espresso
Opaque Glass



SH-808 HORIZONTAL EIGHT LITE
36"W x 80"H | Bright Orange
Opaque Glass
Wood Panel



CONTEMPORARY MAHOGANY TRANSM OPTIONS

Our Contemporary Mahogany Transom Collection features Rectangular Design and Opaque glass to match your entry door.



Rectangular, Opaque Glass, Grey



Rectangular, Opaque Glass, Green

AVAILABLE TRANSM SIZES	
	Opaque Glass
RECTANGULAR	38-1/2" W min - 91" W max 12-1/2" H min - 17-1/2" H max

SH-803 | Walnut
36"W x 80"H | Opaque Glass



PANEL OPTIONS

Our Contemporary Mahogany collection features flexibility with glass & wood panel insert options. Choose from Double Opaque Glass or Solid Wood Panel inserts for each opening.*



Opaque Glass



Solid Wood Panel

All wood panel inserts are 100% solid wood, made of the same wood species of unit and finished to match the unit.



* Mirrored glass/wood panel options for double doors or sidelites.

SH-802 | Walnut
36"W x 80"H | Opaque Glass
Wood Panel





MIX AND MATCH

Our Contemporary Mahogany Collection is designed for seamless combinations between models. Create a unique entryway by mixing and matching not only doors and sidelites, but also glass and wood panels.



DOORS

SH-808 | Red
36"W x 80"H | Opaque Glass

SIDELITES

SH-802 | Red
16"W x 80"H | Opaque Glass

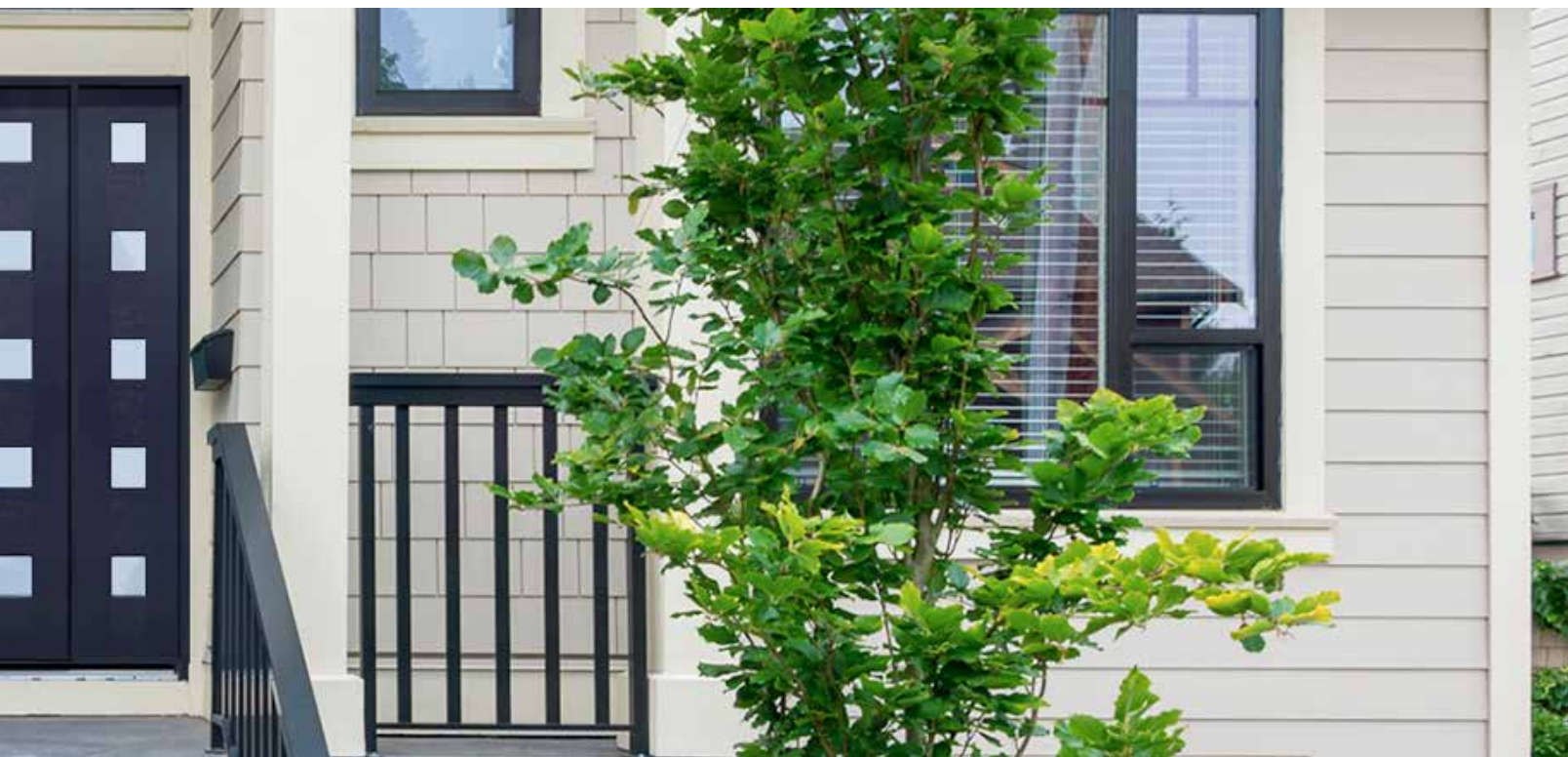



ABOUT THE COLLECTION

Inspired by the 19th century American Arts and Crafts movement, our Craftsman Collection encourages originality, simplicity and warmth.

- 100% Solid Wood No Veneers
- New Sidelite and Transom Designs
- Matching solid wood dentil shelf option
- Custom sizes to fit most openings

FINISHES



Cherry Stain



Walnut Stain



Golden Oak Stain



Espresso Stain



Antique Stain



Unfinished



Blue Paint*



Red Paint*



Green Paint*



Grey Paint*



Desert Sand Wash Stain



Bright Orange Paint



Lime Green Paint



White Paint

* Semi-transparent paint
(Color samples available to store upon request)

GLASS OPTIONS



Clear

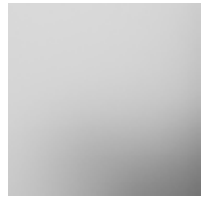

Obscure (upgrade at additional charge)



MODELS



SH-700 SINGLE LITE SQUARE TOP
36"W x 80"H | Cherry
Clear Glass



SH-700 SINGLE LITE SQUARE TOP
36"W x 80"H | Lime Green
Clear Glass
Shelf



SH-700 SINGLE LITE SQUARE TOP
36"W x 80"H | Golden Oak
Clear Glass
Shelf



SH-703 THREE LITE SQUARE TOP
36"W x 80"H | Blue
Clear Glass
Shelf



SH-703 THREE LITE SQUARE TOP
36"W x 80"H | Espresso
Clear Glass



SH-703 THREE LITE SQUARE TOP
36"W x 80"H | Red
Clear Glass

MODELS



SH - 706 SIX LITE SQUARE TOP
 36"W x 80"H | Walnut
 Clear Glass
 Shelf



SH - 706 SIX LITE SQUARE TOP
 36"W x 80"H | White
 Clear Glass
 Shelf



SH - 706 SIX LITE SQUARE TOP
 36"W x 80"H | Bright Orange
 Clear Glass
 Shelf



SHELF



Optional solid wood dentil shelf with dowel pin construction available to complement your craftsman look.

DIAGRAM:

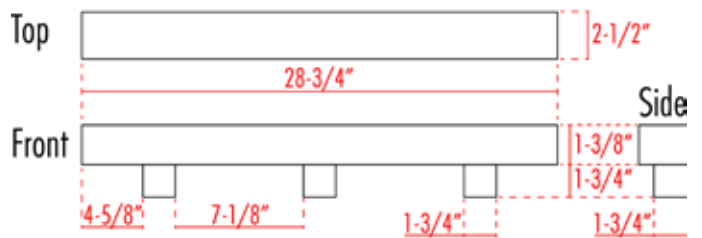

Simplified and not-in-scale diagram for illustrative purposes only.



CRAFTSMAN TRANSOMS

Matching Craftsman Transoms add natural light to your home while complementing your entry door selection. Available with Clear or Opaque Glass



SH-706 | Walnut
36"W x 80"H | Clear Glass



SH-703 | Red
36"W x 80"H | Clear Glass

AVAILABLE TRANSOM SIZES	
	Clear and Privacy Glass
RECTANGULAR	38-1/2" W min - 91" W max 12-1/2" H min - 17-1/2" H max





ABOUT THE COLLECTION

Bring a touch of Europe to your home with Main Door's Dutch Door Mahogany Type Collection. Ultra-functional and stylish our Dutch Door provides the flexibility of a window and the functionality of a door.

- 100% Solid Wood No Veneers
- True divided light glass
- Retractable pull-down screen option
- Custom sizes to fit most openings

FINISHES

	
Cherry Stain	Walnut Stain
	
Golden Oak Stain	Espresso Stain
	
Antique Stain	Unfinished
	
Blue Paint*	Red Paint*
	
Green Paint*	Grey Paint*
	 NEW
Desert Sand Wash Stain	Bright Orange Paint
 NEW	 NEW
Lime Green Paint	White Paint

* Semi-transparent paint
(Color samples available to store upon request)

GLASS OPTIONS

Clear



MODELS



SH-D4X COTTAGE DUTCH DOOR
 30"W, 32"W | Grey
 36"W x 80"H | Clear Glass



SH-D4X COTTAGE DUTCH DOOR
 30"W, 32"W | Golden Oak
 36"W x 80"H | Exterior Shelf
 Clear Glass



SH-D9X NINE LITE DUTCH DOOR
 30"W, 32"W | Espresso
 36"W x 80"H | Exterior Shelf
 Clear Glass



SH-D9X NINE LITE DUTCH DOOR
 30"W, 32"W | White
 36"W x 80"H | Exterior Shelf
 Clear Glass

SCREEN



High quality, custom-fitted, retractable screens are available for units with shelf at additional charge. Aluminum screen frames are available in white or bronze. Screens are not available on unfinished units.

CONSTRUCTION



Our precise construction ensures each door component has a close and proper fit. A panel-overlap construction with rubber weather-strip seal keeps your door protected. Your unit includes a surface-mounted, premium quality Dutch Door Bolt.

SHELF

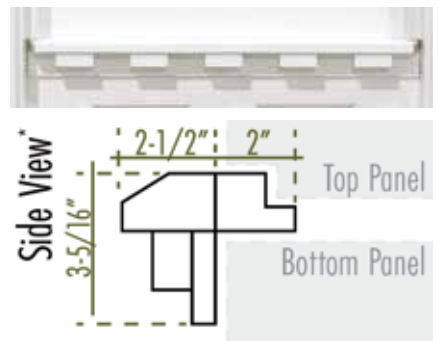

Optional solid wood dentil shelf available to complement the look and functionality of your Dutch door. Shelf required with retractable screen option, not available on unfinished units.

*Simplified and not-in-scale diagram for illustrative purposes only.



ABOUT THE COLLECTION

Our Rustic Platinum doors offer the impressive exotic look of real solid Teak wood with dramatic panel styles to add character to your opulent entryway.

- Solid Teak Construction
- Hand-assembled design pattern
- Unique single hinge-pivot ball-bearing system
- Unique 48" x 96" grand entryway

FINISHES



Rustic Honey Amber

SPECIAL FEATURES

Hinge-Pivot System





MODELS

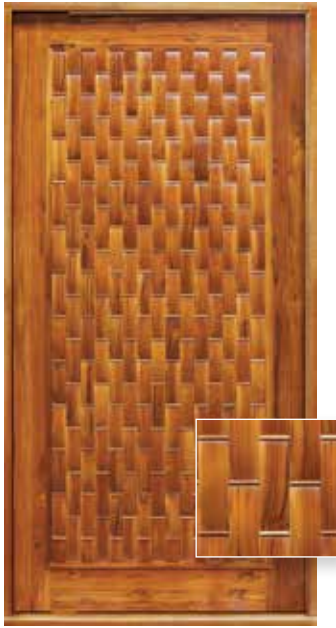

SH-1022 | Rustic Honey
48"W x 96"H | Amber



SH-1020 | Rustic Honey
48"W x 96"H | Amber



SH-1700 | Rustic Honey
48"W x 96"H | Amber





ABOUT THE COLLECTION

Our North America Red Oak collection is proudly harvested from FSC-certified forests. This beautiful, slow growing hardwood is extremely tough and durable.

- 100% Solid American Red Oak No Veneers
- Unique rich grain structure
- Natural un-stained finish availability
- Custom sizes to fit most openings

FINISHES



Dark Walnut Stain



Natural Stain



Red Oak Stain



Light Walnut Stain



Unfinished

(Color samples available to store upon request)

GLASS CAMING OPTIONS



Black Patina



Brass



Zinc



MODELS



SH-554 STANDARD OVAL
36"W x 80"H | Red Oak
Glass B



SH-554 STANDARD OVAL
36"W x 80"H | Dark Walnut
Glass C



SH-555 CENTER ARCH
36"W x 80"H | Natural
Glass A



SH-556 3/4 LITE
36"W x 80"H | Dark Walnut
Glass C



SH-557 DELUXE OVAL
36"W x 80"H | Red Oak
Glass B



SH-557 DELUXE OVAL
30"W x 80"H | Light Walnut
32"W x 80"H | Glass A
36"W x 80"H

AMERICAN RED OAK TRANSOM OPTIONS

Our American Red Oak Collection features 3 different glass styles and 3 unique shapes.



SH-554: Red Oak, Glass C



Half Round, Hand Beveled, Full Glue Chip, Glass C



Elliptical, Hand Beveled, Full Glue Chip, Glass C



Rectangular, Hand Beveled, Full Glue Chip, Glass A



Rectangular, Hand Beveled, Full Glue Chip, Glass B



Rectangular, Hand Beveled, Full Glue Chip, Glass C

AVAILABLE TRANSOM SIZES

	A	B	C
HALF ROUND	N/A	N/A	61"W x 31-1/4"W or 73"W x 37-1/4"H
ELLIPTICAL	N/A	N/A	61"W x 16"H or 73"W x 16"H
RECTANGULAR	42-1/2" W min - 78-7/8" W max 12-1/2" H min - 17-1/2" H max	42-1/2" W min - 78-7/8" W max 12-1/2" H min - 17-1/2" H max	42-1/2" W min - 78-7/8" W max 12-1/2" H min - 17-1/2" H max

DOOR SPECIFICATIONS

Exterior Doors:

- Thickness: 1-3/4"
- Width: 30", 32", 36", 42" for doors & custom 11" to 16" for sidelites
- Height: 6'8" (80") & 8'0" (96")
- Panels: 1-3/4"
- Construction: All solid wood stile and rail that are securely joined by type I glued dowels and solid wood free-floating center panels, no thin veneer over particle board.
- The solid wood stile and rail Mahogany Type and American Red Oak collections only, have raised moldings on one side.



Interior Doors:

- Thickness: 1-3/8"
- Width: 24", 28", 30", 32", 36"
- Height: 6'8" (80")
- Panels: 1-3/8"
- Construction: Solid stile and rail construction and solid wood panels, Dowel Construction, type I exterior glue (no thin veneer over particle board) with floating panels.

PREHUNG CONSTRUCTION

- Custom sizes to fit most openings within configurations (see image below);
- The entry door (active/operable) is pre-drilled with two 2-1/8" face holes for standard bore & deadbolt and a 2-3/8" back set, with standard 5-1/2" vertical spacing and one 1" edge hole (no mortise for strike plate in the jamb leg or mullion);
- Solid wood jamb, in matching species and finish, offered in custom widths: 4-9/16" to 11";
- Jambs not prepped for strike plates due to manufacturer differences;
- Units include 4x4" ball-bearing solid brass hinges, weather-strip, door sweep, and sill.
- Sidelite sizes on every prehung unit are based on the custom net frame width and height



Configurations:

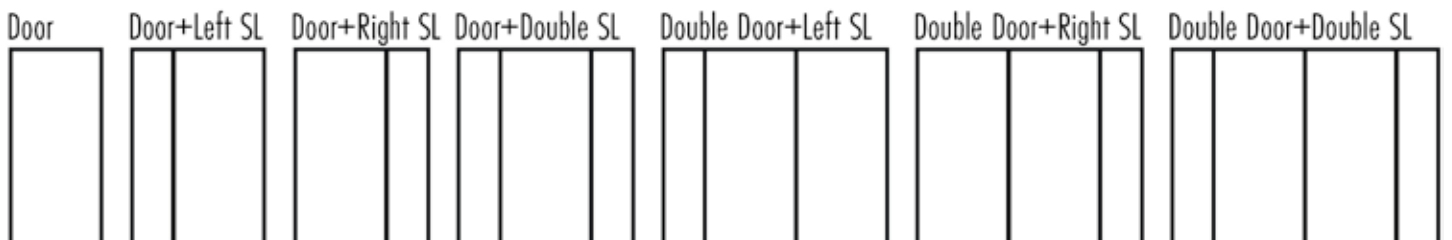

* Slab Doors and Sidelites available on all collections, except Dutch Door Collection.

GLASS OPTIONS

We offer a large variety of glass designs and options, specific to collection and models, to complement your unit.

Specifications:

- 3/4"-thick, triple-glazed
- NAMI-certified
- Argon-filled for energy efficiency
- Decorative, hand-assembled, beveled clusters

Style Options:

- 3 Designs for most models (refer to page 35-36)
- Metal Caming: Brass, Patina, or Zinc (select Collections)
- Rain Glass, Black Patina, or Wrought-Iron Dual Pane (Rustic Collection)
- Privacy or Clear Glass



HARDWARE, SILLS & MOULDINGS



Brass



Bronze



Satin Nickel



Oak Adjustable, Brass



ADA/Handicapped Compliant, Bronze



7-1/4" wide Solid Oak



Out-Swing Bumper Sill, Zinc



Flat Stock*:
3-1/2" — 4"



711 Colonial Casing*:
2-1/2" — 3-1/2"



Eastern Brick Moulding*:
2-1/4" — 4"



Stucco Moulding*:
1-1/2"

* Moulding trim available at additional charge.

CUSTOM GLASS

Dual glazed inserts for square glass models only can be assembled from commercially available stock glass, such as gluechip, reeded, or clear glass (quoted separately). Please allow additional time to quote and verify availability.



VENTING & OPERABLE SIDELITES

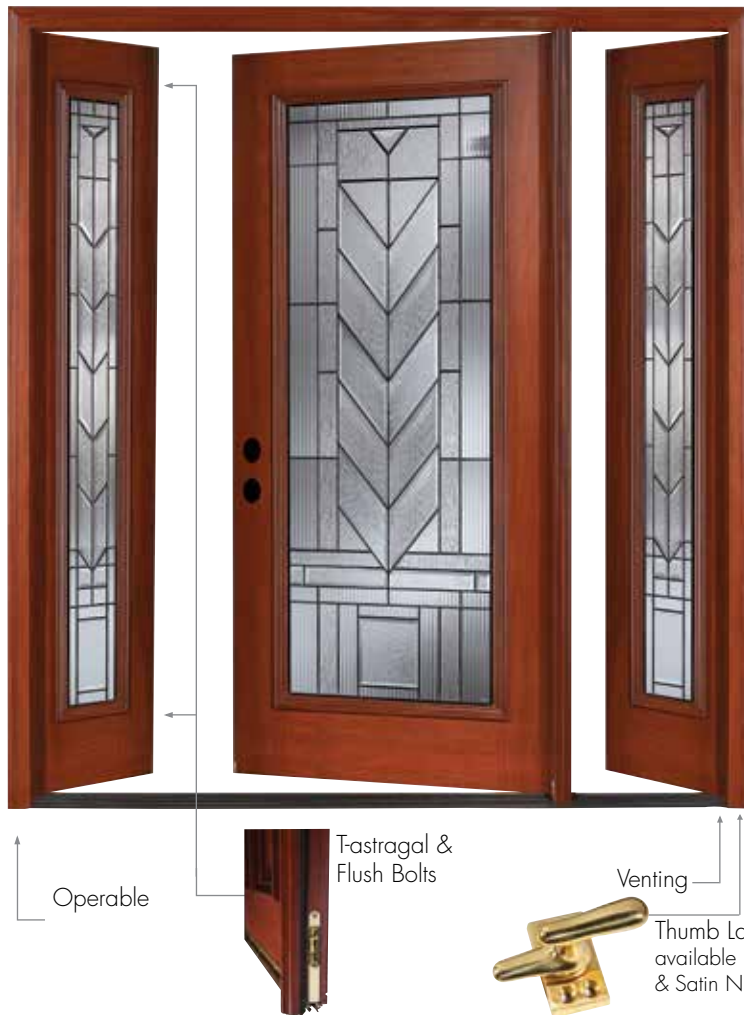

Venting & Operable Sidelites

Main Door offers Venting & Operable Sidelites so to provide customers with the maximum value and flexibility. Venting Sidelites operate like single narrow doors (12"-16" wide) and include a thumb latch to secure door. Operable Sidelites open like a double-door with Tastragal and flush bolts. This increases the maximum opening of a single door by as much as 12"-16" inches. Thumb latches are not installed. Screens are not available through Main Door.

Flush Bolts

Our flush bolts allow secure locking of a secondary door in a double door or an operable sidelite.

In-Swing or Out-Swing

Entry doors can be custom configured as standard in-swing or optional out-swing. Out-swing units ship with special hinges featuring non-removable pins.

OTHER CUSTOM SOLUTIONS



Wider Mull Posts

A wider Mull Post can increase the maximum unit width by as much as 4" per post (additional charge).









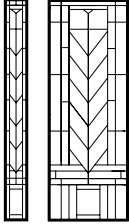
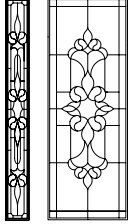

Custom Mouldings & Floor Transitions

Wider, custom mouldings and floor transitions are available (additional charge).

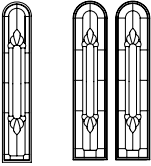
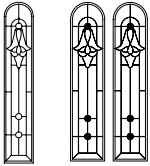
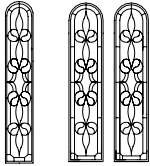
Doors and sidelites can be mixed and matched to your personal taste. These glass options are for Mahogany Type and American Red Oak Collections only.

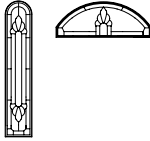
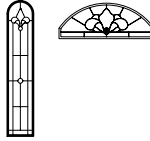
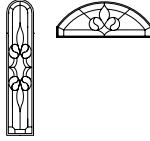

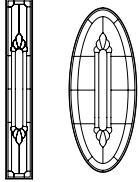
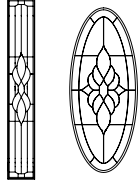
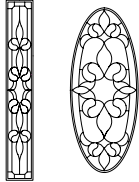

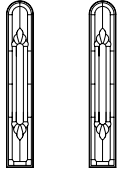
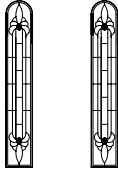
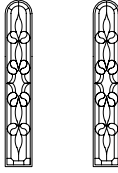



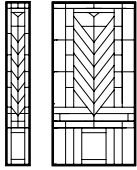
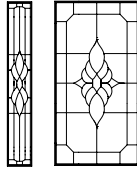
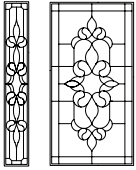

GLASS MODELS

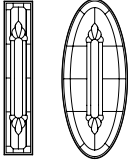
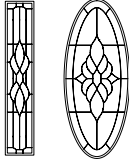
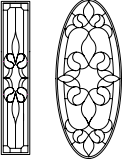
DOOR MODELS

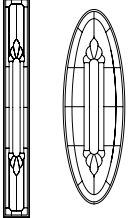
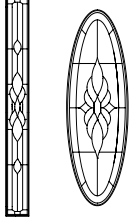
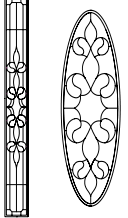
		A	B	C
SH-551 FULL LITE			N/A	
SH-552 DOUBLE ARCH TOP				
SH-553 HALF MOON				
SH-554 STANDARD OVAL				
SH-555 CENTER ARCH				

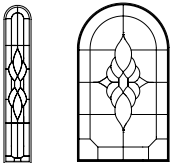
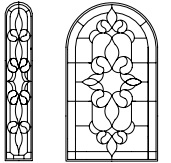
DOOR MODELS

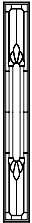
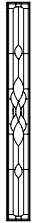
GLASS MODELS

		A	B	C
SH-556 3/4 LITE				
SH-557 DELUXE OVAL				
SH-558 LONG OVAL				
SH-559 3/4 TOP ARCH		N/A		
SH-600 SIX PANEL				

THE BEAUTY OF REAL WOOD

Variations in color, texture and grain between stiles, rails and panels, are what make solid wood products both beautiful and unique and is one reason why they have such appeal. It is a natural characteristic and cannot be misinterpreted as a defect.

Our open-grain finish process enhances the natural beauty of the wood by keeping the wood grains visible. Stain and semi-transparent paint finishes allow the difference in wood tones to be seen. Paint finishes do not allow the difference in wood tones to be seen.



PACKAGING AND SHIPPING

As with our product, we take pride in our production, packaging, palletizing and crating methods. We go through great lengths to ensure that your investment is delivered safely.

All custom orders are packaged using triple-layered cardboard, plastic wrap, and wood pallets with 1x2" and 2x4" framework, ensuring proper shipping and handling of your unit. We ship all orders on an LTL environment, where strict procedures are in place during freight loading.

Immediately upon receipt of the order, The Home Depot must completely inspect all products for any eventual damage. Discovered damage or defective units must be immediately noted on the bill of lading in the presence of the carrier, notified to Main Door Corporation, and shipped back in the same condition in which it was received.



PROTECT YOUR DOOR FROM THE ELEMENTS

All Solid Wood Entry Doors require adequate protection from the elements. Lack of proper overhang will void the warranty. The projected overhang depth must be equal or greater than 1/2 the overhang height for North and East facing doors and equal to the overhang height for South and West facing doors. Overhang width must be twice the width of the door (see graphic). South or Western facing doors will benefit from larger overhangs.

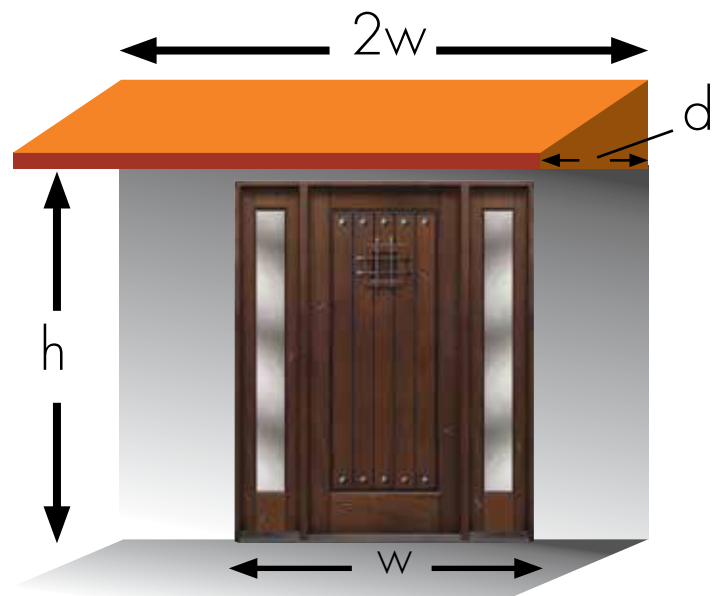

DEPTH OF OVERHANG FOR DOOR FACE DIRECTION

NORTH	SOUTH	EAST	WEST
$d = 1/2 h$	$d = h$	$d = 1/2 h$	$d = h$

Follow the guidelines below for a proper installation and warranty coverage. Professional installation is highly recommended. Warranty will be voided if:

- Storm Door is Installed
- Door is Installed in Direct Sun
- There is No Proper Overhang

AVAILABLE DOOR SIZES

	RUSTIC MAHOGANY TYPE				MAHOGANY TYPE								DUTCH DOOR		CRAFTSMAN			AMERICAN RED OAK				CONTEMPORARY								
	SH-900	SH-901	SH-902	SH-903	SH-904	SH-914	SH-551	SH-552	SH-553	SH-554	SH-555	SH-556	SH-557	SH-558	SH-559	SH-600	SH-D9X	SH-D4X	SH-700	SH-703	SH-706	SH-551	SH-554	SH-555	SH-556	SH-557	SH-802	SH-803	SH-805	SH-808
30" x 80" DOOR					•	•				•			•			•	•	•									•			
32" x 80" DOOR					•	•				•			•			•	•	•									•			
36" x 80" DOOR	•	•	•	•	•	•	•	•	•	•	•	•	•	•	•	•	•	•	•	•	•	•	•	•	•	•	•	•	•	•
42" x 80" DOOR					•					•						•														
16" x 80" SIDELITE	•	•	•	•	•	•	•	•	•	•	•	•	•	•	•				•	•	•	•	•	•	•	•	•	•	•	
36" x 96" DOOR					•					•			•																	
16" x 96" SIDELITE					•					•			•																	

Listed above are the doors and sidelite sizes—width x height—available for each model and for each collection (thickness for all exterior doors and sidelites is 1-3/4"). The standard height for 80" doors is 82-1/2", but can be built from 79-1/2" to 82-1/2"; the standard height for 96" doors is 98-1/2" but can be built from 95-1/2" to 98-1/2". Please call for any custom sizes.

MINIMUM AND MAXIMUM ENTRY WIDTHS

PRE-HUNG UNITS	30" x 32" UNITS	36" UNITS	42" UNITS
SINGLE DOOR	31-1/4" min - 33-1/2" max	36-1/2" min - 37-1/2" max	41-1/4" min - 43-1/2" max
SINGLE DOOR w/1 SIDELITE	43-1/2" min - 53-1/2" max > 50-1/2" = additional charge	48-1/4" min - 57-1/2" max > 54-1/4" = additional charge	53-1/2" min - 63-1/2" max > 60-1/4" = additional charge
SINGLE DOOR w/2 SIDELITE	54-3/4" min - 73-1/2" max > 67" = additional charge	60" min - 77-1/2" max > 71" = additional charge	65" min - 83-1/2" max > 77" = additional charge
DOUBLE DOOR	61-1/2" min - 66" max	72" min - 74" max	82" min - 86" max
DOUBLE DOOR w/2 SIDELITE	85" min - 106" max > 99-1/2" = additional charge	95-1/2" min - 114" max > 107-1/2" = additional charge	105-1/2" min - 126" max > 119-1/2" = additional charge

Listed above are the net width ranges of framed sizes available for prehung units by configuration (sizes are always net outside dimensions).

FRAMED SIDELITES

NET FRAME WIDTH	NET FRAME HEIGHT (80" UNITS)	NET FRAME HEIGHT (96" UNITS)
12-1/2" min - 17-1/2" max	79-1/2" min - 82-1/2" max	95-1/2" min - 98-1/2" max

RUSTIC PLATINUM TEAK COLLECTION

DOOR SIZE	NET FRAME SIZE	ROUGH OPENING
48" X 96"	51" X 99"	51-1/2" X 99-1/2"

Custom sizes are not available in this collection. Jambes are available in wall thickness from 5" to 5-1/2".

INTERIOR DOORS

DOOR SIZE	SINGLE PREHUNG NET SIZE	DOUBLE PREHUNG NET SIZE
24" X 80"	25-1/2" X 81-1/2"	49-1/2" X 81-1/2"
28" X 80"	29-1/2" X 81-1/2"	57-1/2" X 81-1/2"
30" X 80"	31-1/2" X 81-1/2"	61-1/2" X 81-1/2"
32" X 80"	33-1/2" X 81-1/2"	65-1/2" X 81-1/2"
36" X 80"	37-1/2" X 81-1/2"	73-1/2" X 81-1/2"

Custom sizes are available. Maximum trimming allowance on width is 1" and maximum height on door panel is 77". Rough openings add 1/2" on height and 1/2" width to the net unit size. Consult myCD for availability.



2020-2021 EXTERIOR & INTERIOR DOOR CATALOG

UP TO 4 WEEK PRODUCTION TIME