

Question, problems, missing parts? Before returning to the store,
call Home Decorators Collection Customer Service Team
8 a.m. – 7 p.m., EST, Monday – Friday
9 a.m. – 6p.m., EST. Saturday

1-800-986-3460

www.homedepot.com/homedecorators.

THANK YOU

We appreciate the trust and confidence you have placed in Home Decorators Collection through the purchase of this Westbrook 3-Light Vanity. We strive to continually create quality products designed to enhance your home. Visit us online to see our full line of products available for your home improvement needs. Thank you for choosing Home Decorators Collection!

Table of Contents

Table of Contents	2
Safety Information	2
Warranty.....	2
What is Covered.....	2
What is not Covered.....	2
Pre-Assembly	3
Planning the Installation	3
Tools Required.....	3
Hardware Included	3
Package Contents.....	4
Assembly and Installation	5-6
Operation.....	7

Safety Information

- Before starting installation of this fixture or removal of a previous fixture, disconnect the power by turning off the circuit breaker or by removing the fuse at the fuse box.
- Consult a qualified electrician if you have any electrical questions or need to replace the driver.
- If you have any non-electrical questions about this fixture, please contact our Customer Service Team at 1-800-986-3460 or HOMEDEPOT.COM/HOMEDECORATORS



WARNING: Disconnect the power prior to removing or installing a light fixture.



CAUTION: Risk of Fire - This product must be installed in accordance with the applicable installation code by a person familiar with the construction and operation of the product and the hazards involved.
Use minimum 90°C supply conductors.

Warranty

WHAT IS COVERED

The manufacturer warrants this lighting fixture to be free from defects in materials and workmanship for a period of five (5) years from date of purchase. This warranty applies only to the original consumer purchaser and only to products used in normal use and service. If this product is found to be defective, the manufacturer's only obligation, and your exclusive remedy, is the repair or replacement of the product at the manufacturer's discretion, provided that the product has not been damaged through misuse, abuse, accident, modifications, alterations, neglect or mishandling.

WHAT IS NOT COVERED

This warranty shall not apply to any product that is found to have been improperly installed, set-up, or used in any way not in accordance with the instructions supplied with the product. This warranty shall not apply to a failure of the product as a result of an accident, misuse, abuse, negligence, alteration, or faulty installation, or any other failure not relating to faulty material or workmanship. This warranty shall not apply to the finish on any portion of the product, such as surface and/or weathering, as this is considered normal wear and tear. The manufacturer does not warrant and specially disclaims any warranty, whether expressed or implied, of fitness for a particular purpose, other than the warranty contained herein. The manufacturer specifically disclaims any liability and shall not be liable for any consequential or incidental loss or damage, including but not limited to any labor/expense costs involved in the replacement or repair of said product.

Contact the Customer Service Team at 1-800-986-3460 or visit www.homedepot.com/homedecorators.

Pre-Assembly

PLANNING THE INSTALLATION

Read all instructions before assembly and installation. Before starting installation of the fixture or removal of a previous fixture, disconnect the power by turning off the circuit breaker or by removing the fuse at the fuse box. To avoid damaging this product, assemble it on a soft, non-abrasive surface such as carpet or cardboard.

TOOLS REQUIRED

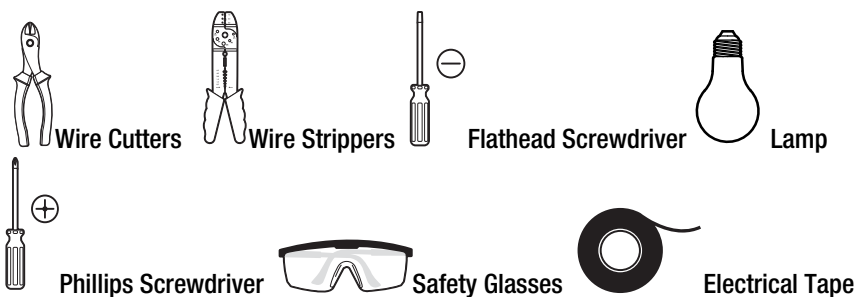

HARDWARE INCLUDED



NOTE: Hardware not shown to actual size.

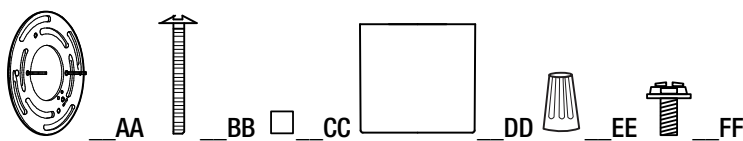

Part	Description	Quantity
AA	Mounting Plate w/Stud	1
BB	Mounting Screw	2
CC	Cap Nut	2
DD	Shade Ring	3
EE	Wire Nut	3
FF	Ground Screw	1

Pre-Assembly (Continued)

PACKAGE CONTENTS

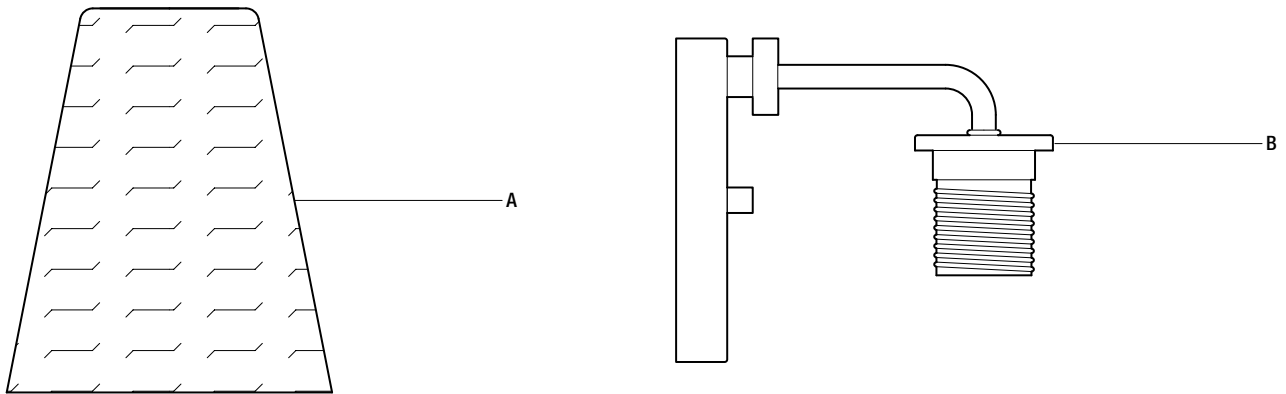

Part	Description	Quantity
A	Shade	3
B	Fixture Base	1

Assembly and Installation

1 Installing the mounting plate

- Remove the mounting plate (AA) from the fixture base (B) by unscrewing the two cap nuts (CC) and sliding the mounting plate (AA) out.
- Install the mounting plate (AA) by placing it over the junction box and aligning the slots to the mounting holes on the junction box.
- Secure the mounting plate (AA) with the two provided mounting screws (BB).

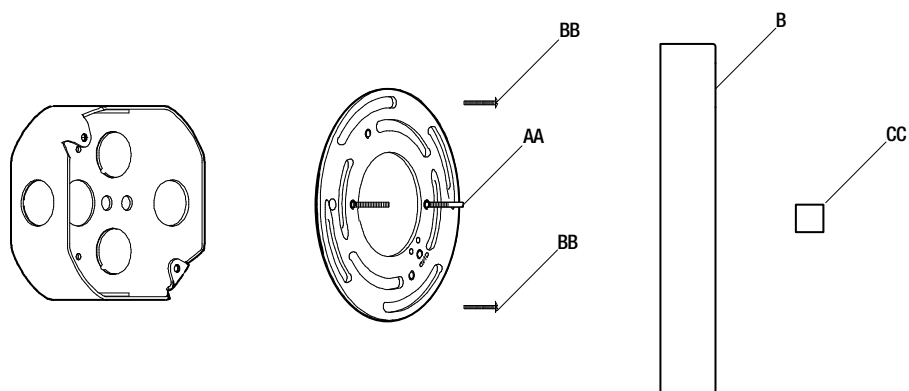

2 Wiring the fixture

- Wrap the middle of the round wire from the fixture around the ground screw (FF) on the mounting plate (AA). Use a wire connector (EE) to connect the ground wire from the fixture to the ground wire from the outlet box.
- Connect the white (-) fixture wire (square and/or rigid) to the neutral (-) power line wire with a wire nut (EE).
- Connect the black (+) fixture wire (round and/or smooth) to the hot (+) power line wire with a wire nut (EE).

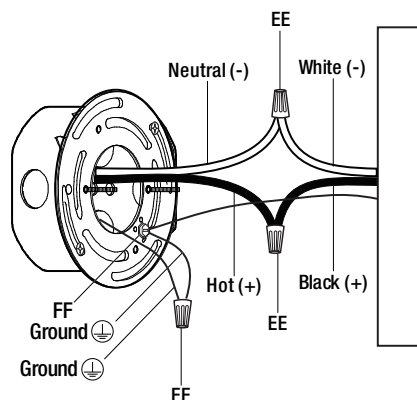

Assembly and Installation (Continued)

3 Mounting the fixture

- Place all wire nut connections into the junction box.
- Align the slots in the fixture base (B) to the mounting plate (AA) and slide it onto the mounting plate studs.
- Secure the fixture in place with two cap nuts (CC).

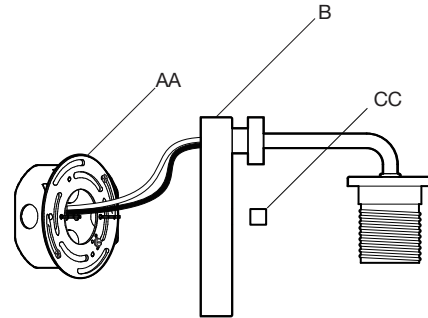

4 Assembling the fixture

- Slide the shade (A) over the socket of the fixture base (B).
- Screw the shade ring (DD) onto the socket to secure the shade (A) in place.
- Screw a lamp (sold separately) into the socket. Refer to the socket label for max wattage information.

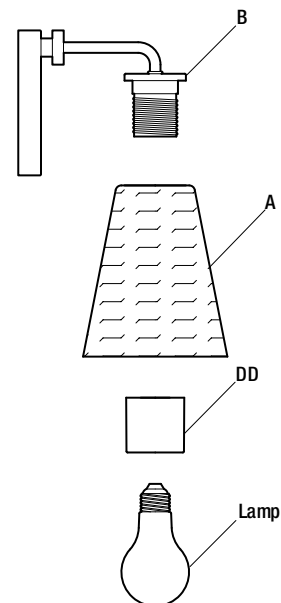

Operation

- Turn on the power at the circuit breaker or fuse box.
- Turn on the light switch to activate the fixture.

HOME DECORATORS COLLECTION®

Question, problems, missing parts? Before returning to the store,
call Home Decorators Collection Customer Service Team

8 a.m. – 7 p.m., EST, Monday – Friday

9 a.m. – 6p.m., EST. Saturday

1-800-986-3460

www.homedepot.com/homedecorators.

Retain this manual for future use.