

Assembly Instructions

Caution: You must read this before you proceed.

Recliner

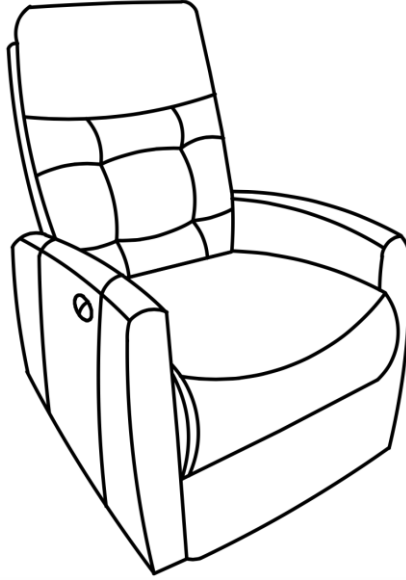

Part List

Label	Picture	Description	QTY
A	A line drawing of a rectangular chair backrest with a grid pattern.	Chair Backrest	1
B	A line drawing of a chair base with a footrest, shown from a three-quarter perspective. It has a curved front edge and a small circular detail on the left side.	Chair Base with Footrest	1

Assembly Preparation

Before Beginning
Assembly:

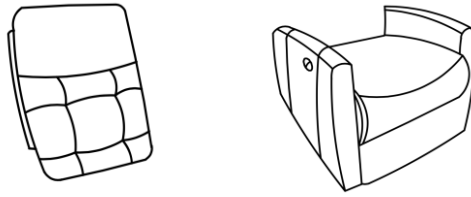

- Read instructions, cover to cover-



- Have 2 adults on hand for assembly-



- Do not assemble on flooring or carpet-



- Assemble on a clean non-marring surface (packing foam)-



- Save all packaging until finished-

Assembly Steps

Overview

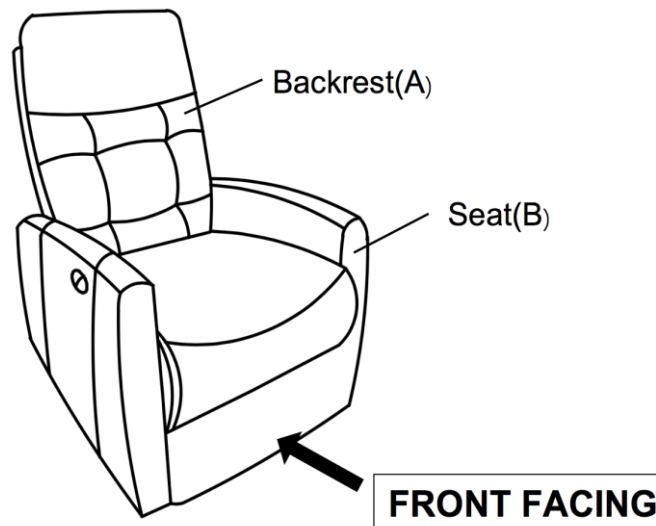

This Reclining Chair has multiple parts and may require up to 30 minutes to assemble. To give you an overview of the Recliner Chair parts, the above picture is to help you put the various parts into perspective. Please read through the instructions below to familiarise yourself with the parts and steps before assembly.

Step 1

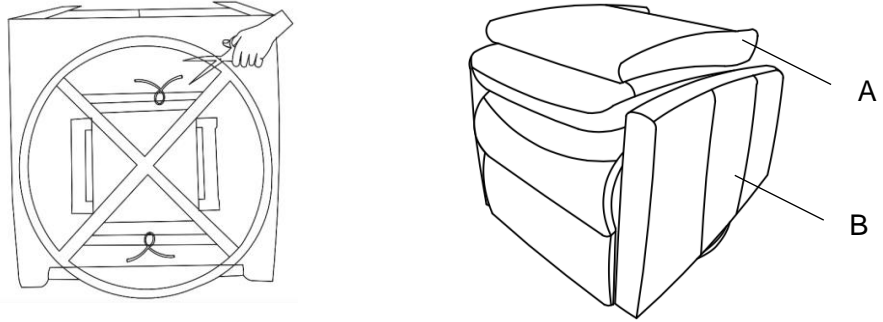

Carefully cut the strips on the bottom of seat with a pair of scissors.
Remove Chair Backrest(A) from the Chair Base with Footrest(B).

Step 2

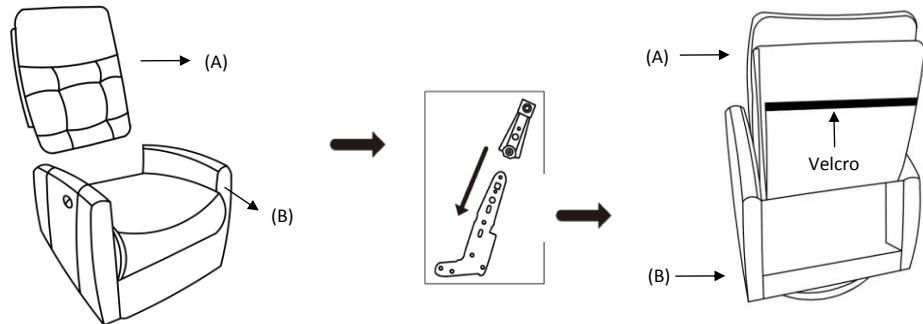

With assistance from your adult partner, hold up the Chair Backrest(A), standing behind the Recilner Chair.
Insert the small metal arms on the sides of the Chair Backrest(A) into the prefabricated slide lock gadget on the Chair Base with Footrest(B) as shown above.
Firmly but gently, push the Chair Backrest(A) downwards until the Backrest(A) is fully slotted and locked into position.

Step 3

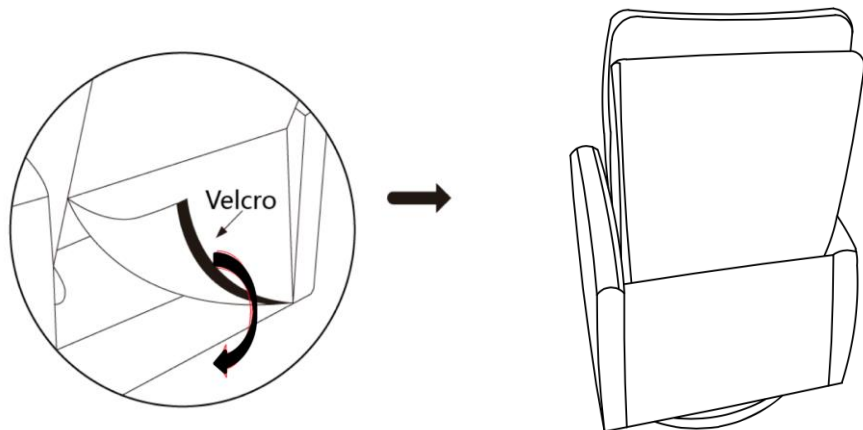

Smooth down the fabric flap on the Chair Backrest(A).
Run your hands down both sides of the flap, from top to bottom, allowing the velcro tape to adhere to the flap under the seat of Recliner Chair.

Step 4

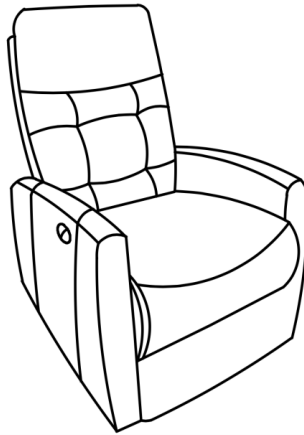

Make sure all parts are connected and securely locked into position.
Your Recliner Chair is ready for use.
This Recliner Chair can only be used on a flat, level surface.

Step 5

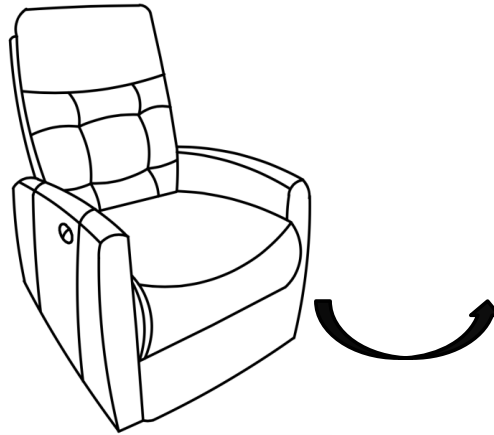

When you are seated on the chair you can swivel round any angle you want by using your legs.

Step 6

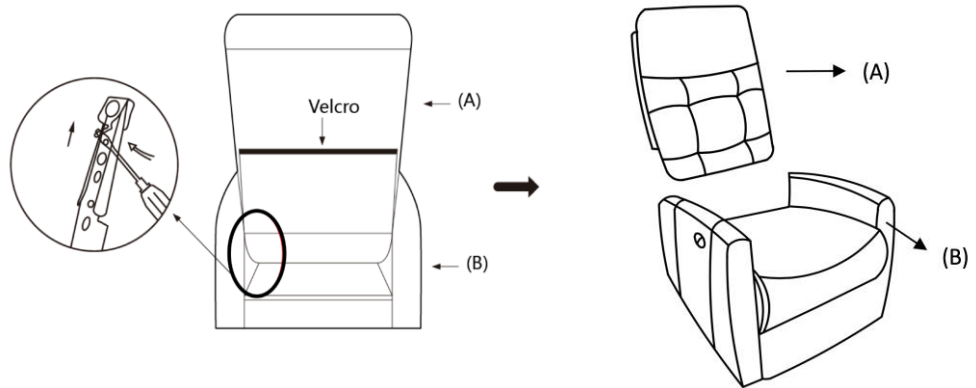

Disassembly Note:

Open the flap on the Chair Backrest(A), use a screwdriver (Don't use fingers) pressing outward on the metal ear on the preattached Metal Bracket on one side of the Chair Base(B), with assistance of you adult partner to keep the Chair Base(B) in place, pull out the Chair Backrest(A) upward at the same time. Repeat the same step for the other side. Then the Chair Backrest(A) can be taken out.

User Instructions.

Reclining Chair

Please read the Instruction Manual below carefully before use.

Children must be supervised when using this Recliner Chair.

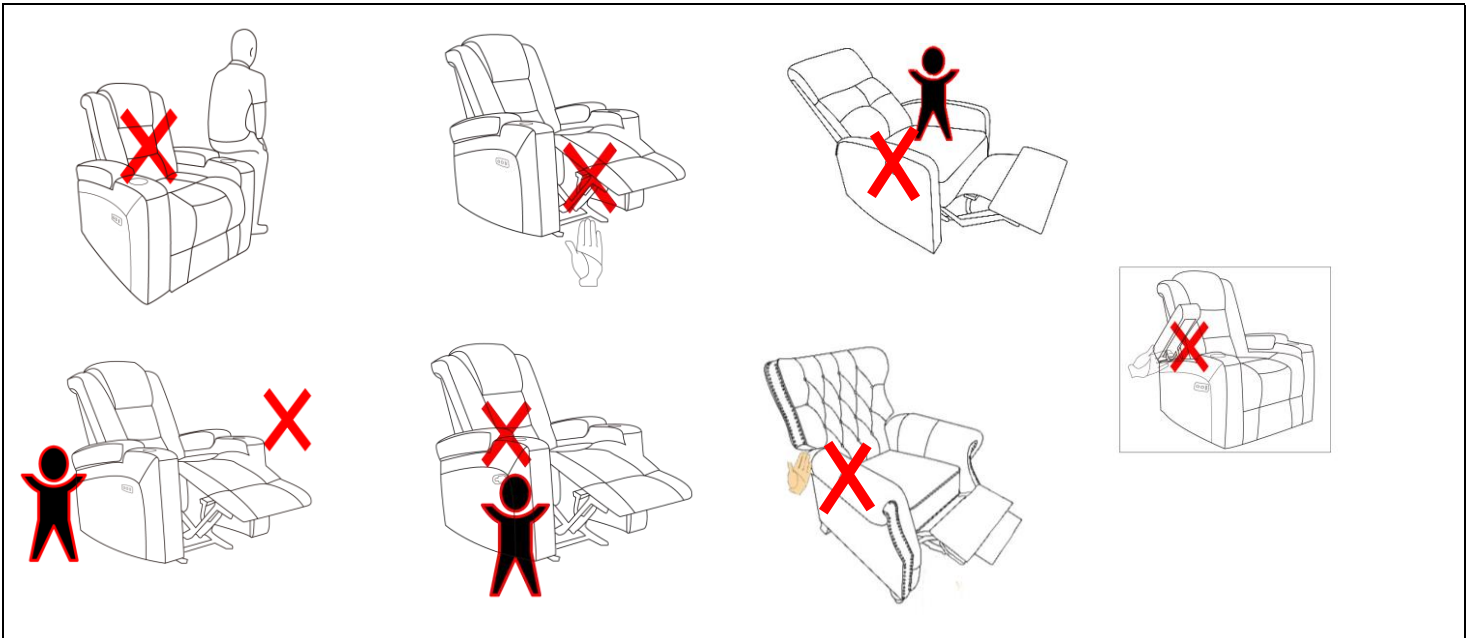

Do not let children stand in front of or behind the Reclining Chair when opening or closing the footrest.
 Do not put your hands inside the Footrest when opening or closing the footrest.
 Do not sit on the arms of the chair.
 Do not stand on the chair.
 Do not put your hands between the back and the armrest.
 Do not put your hands around the clips of the storage arm.

To recline backrest:

Sit into the seat.
 Pull the Button on the outside of the right armrest.

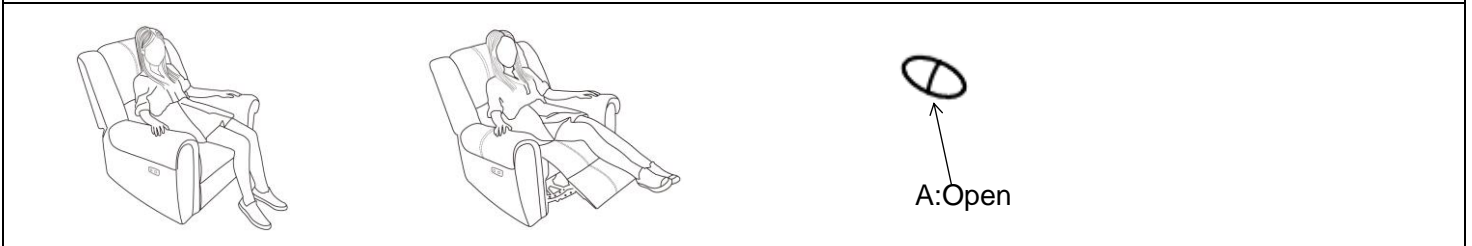





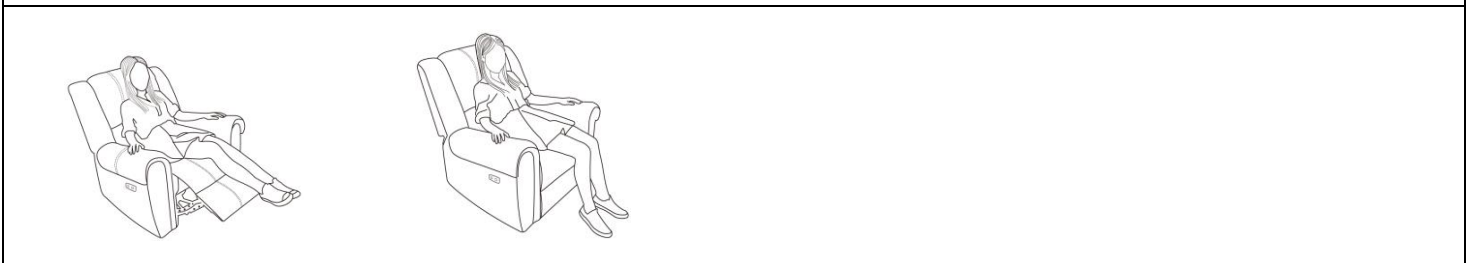





To get out of Chair:

Push the Footrest with your Legs then you can stand up.



Care & Maintenance

-  ● Do not put hot items directly on furniture surface
-  ● Do not clean furniture with harsh cleansers or polish.
-  ● Do not place furniture under direct sunlight.
-  ● Do not place furniture near heating or cooling vents.
-  ● Do not write on furniture without a padded barrier to protect the surface.
-  ● Do not place furniture outside . For indoor use only .
-  ● Not for commercial use. For residential use only .
-  ● Stains may be removed with mild soap solution and damp cloth.
-  ● Children should not climb or jump on the furniture.

-
-  ● Dust and pick-up spills using a clean, non-colored, lint-free cloth .