

Prolux

*Wet-Dry
Garage Vacuum*



Instruction Manual

Contents

Safety Instructions -----	2-3
Included Parts -----	3-4
Assembly Instructions -----	5
Operating Instructions -----	7
Using the Tools -----	10
Maintenance -----	13
Trouble Shooting -----	15
Additional Available Parts-----	15
Technical Data -----	16
Warranty Information -----	17

Congratulations on the purchase of your Prolux Wet Dry Garage Vacuum!

The Prolux Wet Dry is attractive, powerful and makes your life easier.

- Powerful – an amazing 107 cubic feet-per-minute of air flow
- 3-Year Factory Warranty
- Vacuums up dry dirt or water
- Indicator tells you when dirt bin needs emptying or water changed
- Auto shut-off when full of water
- A tool for nearly every job
- Can be used to vacuum, blow, inflate, clean wet spills, or shampoo
- Easily mounts on your wall for easy, out-of-the-way storage

Important Safeguards!

When using an electrical appliance, always follow basic precautions, including the following:

READ ALL INSTRUCTIONS BEFORE USING THIS APPLIANCE

Warning:

To reduce the risk of fire, electric shock, or injury:

- Do not use outdoors
- Close supervision is necessary when any appliance is used by or near children.
- Do not allow cleaning system to be used as a toy or to run unattended at any time.
- Do not allow any objects to be put into hose inlet.
- Do not pick up anything that is burning or smoking, such as cigarettes, matches, or hot ashes.
- Do not use to pick up flammable or combustible liquids such as gasoline or fine wood sanding or use in areas where they may be present.
- Avoid picking up sharp objects.
- Do not use without filter in place. Empty dirt container and clean filter frequently when picking up very fine materials such as powder.
- Do not put any objects into openings. Do not use with any openings blocked.
- Keep free of dust, lint, hair, and anything that may reduce airflow.
- Do not pull or carry by cord, use cord as a handle, close a door on cord or pull cord around sharp edges or corners. Do not run appliance over cord. Keep cord away from heated surfaces.
- Always disconnect cord from electrical outlet before servicing the power unit.
- Do not unplug by pulling on cord. To unplug, grasp the plug, not the cord. Never handle plug or appliance with wet hands.
- Turn off all controls before unplugging. Unplug cleaner when not in use.
- Do not use with damaged cord or plug. If appliance is not working as it should, has been dropped, damaged, left outdoors, or dropped into water, take it to a Professional Vacuum Service Center or Prolux Authorized Vacuum Service Dealer.
- Use vacuum cleaner only for its intended use as described in this owner's manual. Use only attachments recommended by the manufacturer. Other attachments may cause hazards.
- This appliance is provided with double insulation. Use only identical replacement parts. Servicing a double-insulated appliance requires extreme care and knowledge of the system and should be done only by qualified service personnel.

- Keep hair, loose clothing, fingers, and all parts of body away from the opening and moving parts.

Save these instructions!

WARNING

Operate cleaning system only at voltage specified on power unit.

This system is intended for residential use.

WARNING

To reduce the risk of electric shock, this appliance has a polarized plug (one blade is wider than the other). This plug will fit in a polarized outlet only one way. If the plug does not fit fully in the outlet, reverse the plug. If it still does not fit, contact a qualified electrician to install the proper outlet. Do not change the plug in any way.

Parts of the Vacuum

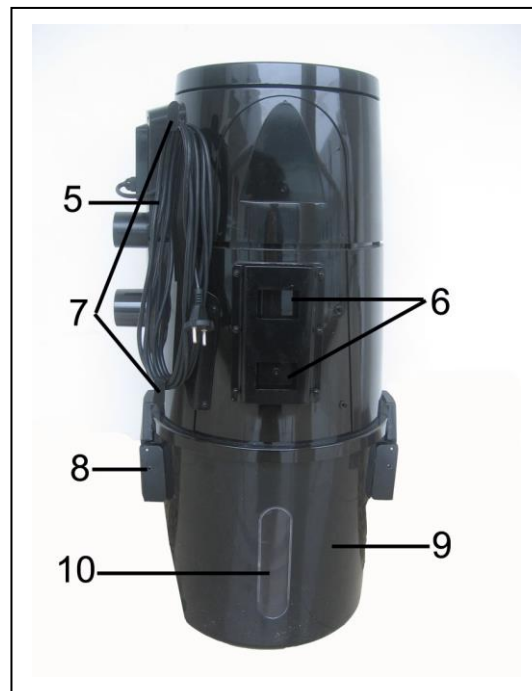
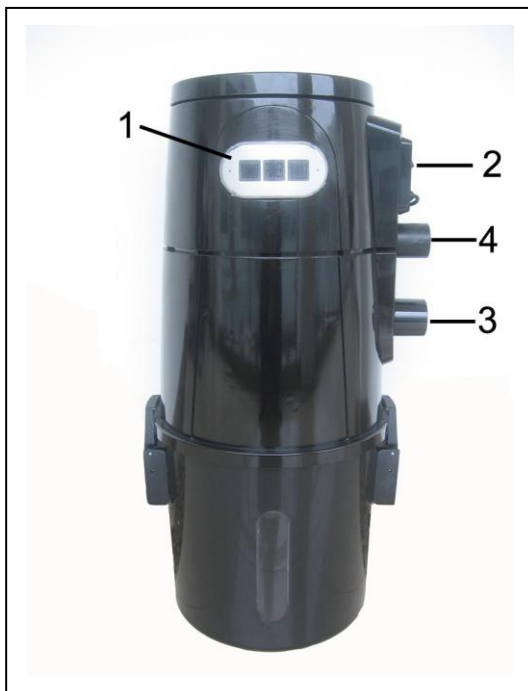

1. Face Plate
2. Power Switch
3. Wet/Dry Hose Inlet
4. Blower Hose Outlet
5. Power Cord

6. Slots
7. Power Cord Hook
8. Dirt Tank Handles
9. Dirt Tank
10. Dirt Viewing Window

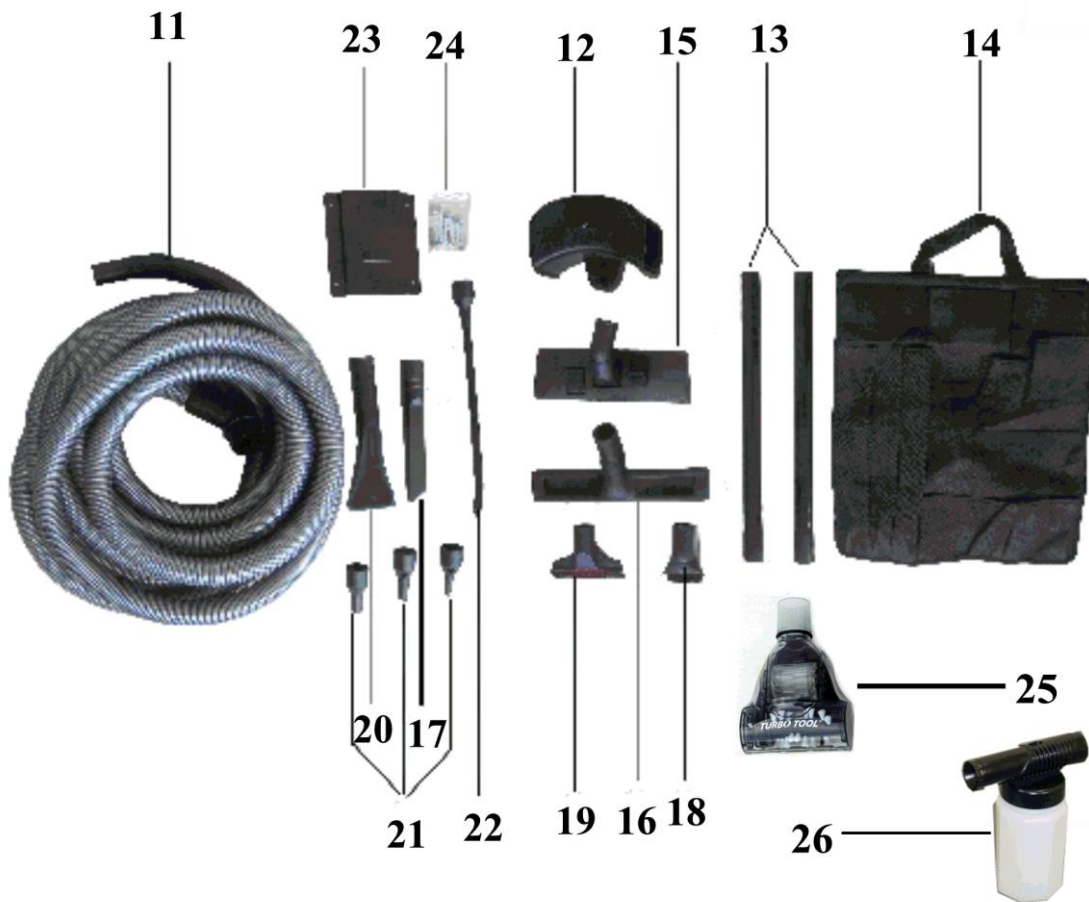

Included Accessories & Parts

11. 32ft Flexible Crush Proof Hose 12. Hose Holder 13. Extension Wands 14. Accessory Tool Caddy 15. Multi-Surface Floor Tool 16. Wet Pickup Squeegee Floor Tool 17. Crevice Tool	19. Upholstery Tool 20. Extraction Shampooer Suction Tool 21. 3 Sizes of Detailing & Inflator Tools 22. Long Detailing Precision Blower Tool 23. Wall Mounting Bracket 24. Screws 25. Mini Head with Spinning Brushroll 26. Suds Gun Sprayer Washer
--	--

A detailed description of how to use the above tools is listed on page number 9.

Assembly Instructions

1. Remove the dirt tank by pulling up on both handles to unlatch. Lift upper half of unit to remove.
2. Remove all accessories and parts stored in the bottom of the tank prior to use.
- 3. If the round funnel comes out of dirt tank, set back inside the dirt tank before reassembling.**
- 4. To reassemble, place the top of the unit on the dirt tank so the edges fit together and latch the handles to secure the top and bottom of unit.**
5. Mount to wall (see instructions below).

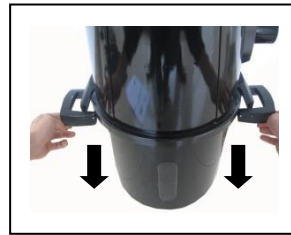
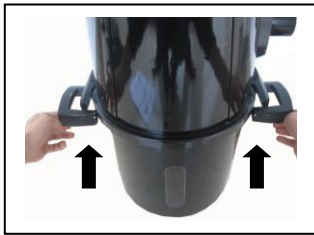

Mounting & Installation Instructions

Mounting on drywall or plaster wall with stud (fasteners included)

1. Locate a stud in your dry wall and drill a 1/8" pilot hole.
2. Mount the bracket with a #10-16 x 1-3/4" screw.
3. Ensuring your bracket is aligned correctly with the stud, drill a second pilot hole using the next hole as a guide. Securely fasten with a screw.
4. Repeat step 3 for remaining hole.

Note: mount near a wall outlet, making sure the cord provided will reach the outlet.

5. Mount the unit by making sure the two square slots on backside of unit are sitting on the two hooks on the mounting bracket.

See Mounting Images on the next page.

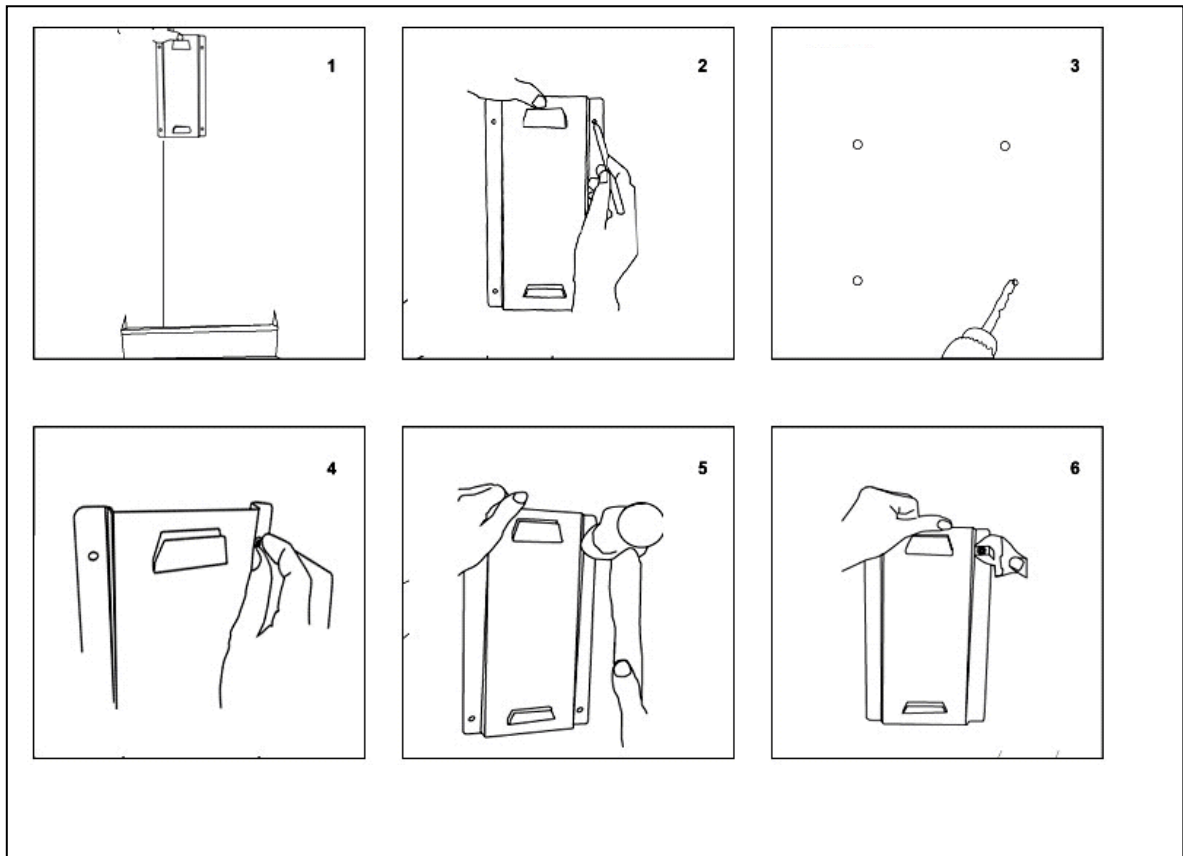

Mounting on concrete wall (fasteners included)

You will need: (4) 3/8" x 2-1/4" concrete sleeve anchors.

1. Drill a 3/8" x 1-3/4" hole with a masonry drill bit.
2. Insert a bolt and anchor sleeve into the hole.
3. Align the bracket over the hole and mark the remaining hole locations using the (4) holes of the mounting bracket. Remove the bracket and drill remaining holes.
4. Mount the bracket starting at top corner hole, tightly securing sleeve anchor with hex nut.
5. Repeat for three remaining holes.
6. Mount the unit by making sure the two square slots on backside of unit are sitting on the two hooks on the mounting bracket.

4
holes

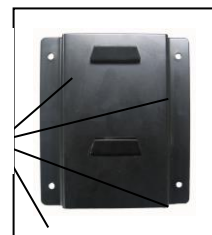

Mounting the Hose Holder (fasteners included)

1. Determine desired location for hose holder and screw 1-1/4" screw into stud.
(If mounting into drywall with no stud available, use supplied drywall anchors.)
2. Hang holder from screw and insert 2-1/2" screw in bottom hole of hose holder to finish mounting.
3. Wrap hose around holder.

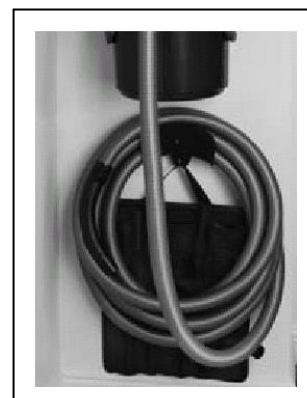

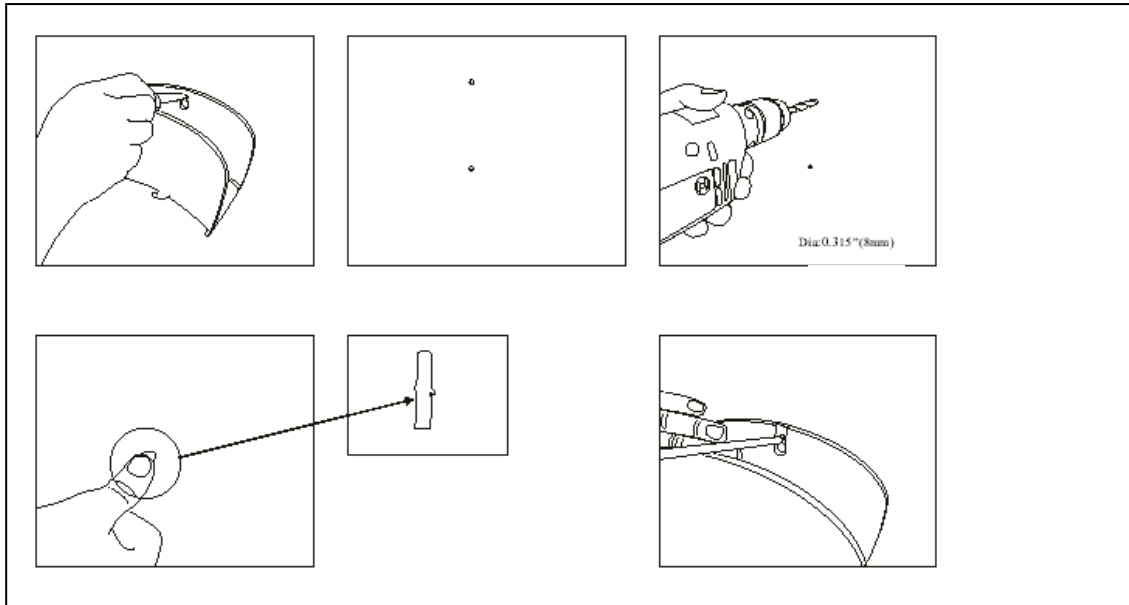

Hanging the Unit

Hang your unit by putting the unit slots to the mounting bracket.

Note: Make sure the unit fits securely on the mounting bracket and won't fall down.

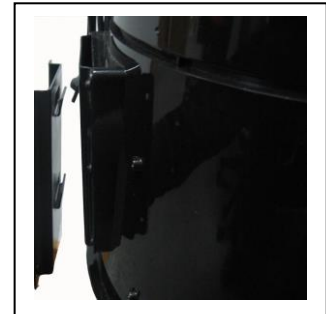

Operating Instructions

Wet/dry vacuuming mode

1. Plug in unit and locate the hose connector into the air inlet. See picture 'A' below. Attach extension wand, if desired, to end of hose by pushing it firmly into the hoses and twisting. All hose and tool connections are attached by friction fit method (shoving together and twisting to the right for firm connection). Attach additional wands or tools as desired. Switch on and start vacuuming.

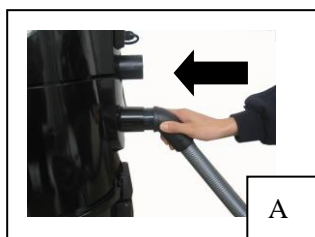

Note: the power switch is located on the top right side of the vacuum. Part 2 in 'E' "Know Your Product."

To turn vacuum on, (I) press up.

To turn vacuum off, (O) press down.

2. If the middle indicator turns green on the indicator screen, it indicates that the appliance is working as it should.
3. If the right yellow light indicator is on, it means canister is full of dirt or clogged.
Switch off immediately when the light turns red.

Solution:

- ① Empty the dust canister (See “Unit Cleaning” below)
- ② Clean the HEPA filter and cloth filter (See “Unit Cleaning” below)

The right indicator turns yellow when airflow is restricted, which can affect the “pick up” performance of the unit. Therefore, it is suitable to clean the dust canister and the filter regularly (every 15 to 30 days).

4. Left red light is the water full indicator. The unit stops sucking up when the indicator turns red, meanwhile the motor will automatically turn the unit off. To change simply **unplug the unit** and empty the water from the dust canister. (See “Unit Cleaning” below) The unit will start again after replacing the dust canister.

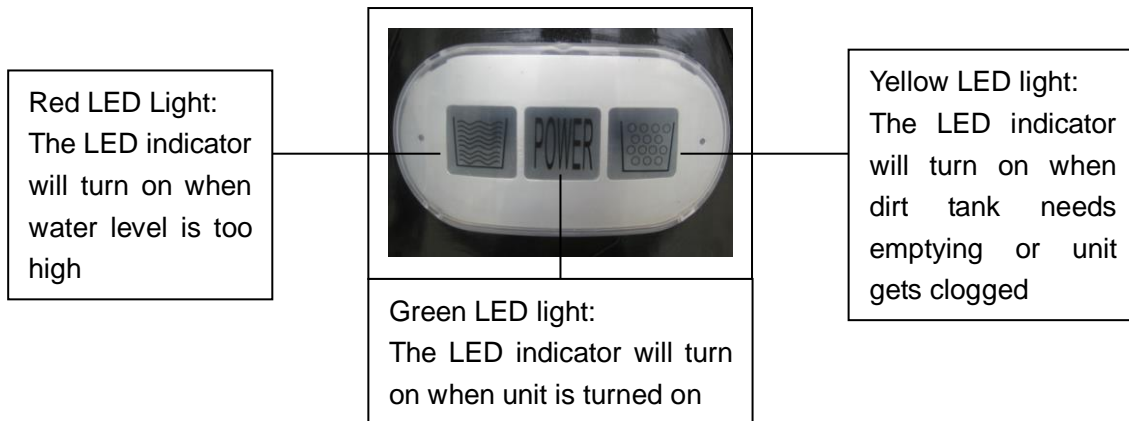

Important:

- a. Unplug the unit when the indicator turns yellow and wait at least 5 seconds before attempting to resume the appliance.
- b. Empty the dust canister before vacuuming again. Two copper sensor poles on the probe should be clean, otherwise the sensing function of the probe will be affected.

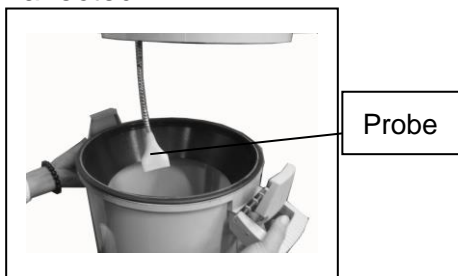

- c. After sucking up water, make sure the filters are dry before attempting to vacuum dust or dirt.
- d. When the dust canister is full of water, remove the dust canister by holding the dust canister handle and rising up by a 10mm distance. Then turn off the hook and pull the dust canister towards you. Do not attempt this task by one hand and notice the dust canister cannot be gradient, which can cause the dust canister to come off easily.
- e. If the appliance water exceeds 10L and it doesn't power off, it means the appliance has a problem, so immediately power it off. Pour off the water in the bucket, check the copper pole of the detector and determine whether it's clean. Clean the copper pole by taking a bottle of water, open the appliance, and then submerge the detector with the water. If the appliance is powers off, then the

problem was because the copper pole was dirty and choked. The appliance should now be ok. If not, there are other problems and it should be sent to repair. (See picture A)



A

Vacuuming Liquids:

- a. After vacuuming liquids, keep the appliance running up to 3 minutes. Also, keep tubes on to eliminate any liquid spills.
- b. If the filter has water in it and it flows to the motor, cut off the power immediately. Please contact a technician.

Blower Mode:

This appliance also functions as a blower, sprayer, and shampooer. Attach to the blower hose to the outlet by inserting the gap in the tube plug to the hook of the exhaust and turn 90 degrees. See picture 'A' below. Attach extension wand, if desired, to end of hose by pushing it firmly into the hose. Attach additional wand or tool, if desired, by firmly inserting onto the wand. Start the appliance and begin blowing. Plug in the unit and push the power switch up to begin blowing.

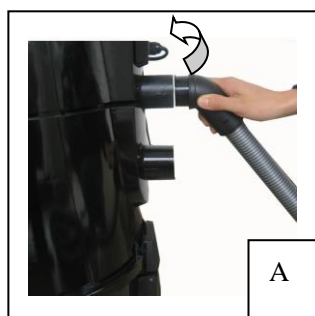

Tip:

To increase output, use the thumb or/and index finger to press on the one or two holes on the tube.

Note:

Do not exceed 3 minutes with this process.

Safety device:

1) The appliance has a protection device to automatically power off when the water is full. It prevents water from reaching the motor. If this happens, the red light will turn on indicating the tank needs immediate emptying.

2) A temperature protection device has been installed. When the temperatures exceed the rated limit, it will power off for protection. If this happens, clean filters and wait 30 minutes before reusing.

3) In the event of a clogged or full dirt tank, the yellow light will turn on indicating the dirt tank and filter need cleaning. To ensure best performance, clean the tank and filter every 15-30 days.

Using the Tools

Make sure the tools are secure to the hose or wand before using.

1. Attach extension wand to end of hose by pushing it firmly onto the hose and twisting.
2. Attach additional wand or tool, if desired, by firmly inserting onto the wand and twisting.
3. Use the hose and wand alone or attach any of the tools to the end of the hose wand.

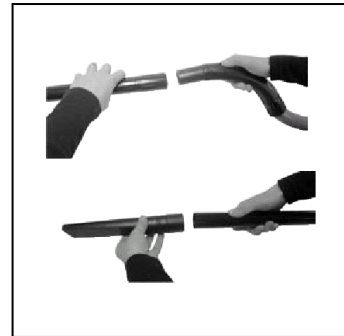

Accessories:

32 ft flexible crush-proof hose

Hose holder

Accessory Caddy



Mounting Bracket



Floor cleaning:

(2) Extension wands

Use with desired attachment for a longer reach.

Wet Pickup Squeegee Floor tool.

Multi-surface floor tool

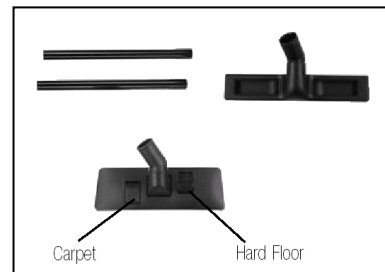

Small Tool Cleaning:

Crevice tool

Upholstery Tool

Dusting brush



Auto Clean & Inflating:

Water Extraction Suction tool.

Precision blower tool for detailing

Small, medium and large detailing and inflating tools.



TOOL USE

11. 32ft Flexible Crush-Proof Hose – Connects to the vacuum on suction side or blow side.

12. Hose Holder – 32 ft hose can be neatly stored here.

13. Extension Wands – 2 extension wands can be used for hard-to-reach places. Also it is used with floor tools.

14. Accessory Tool Caddy – When tools are not in use they may be stored in the tool caddy. The tool caddy can be wall-mounted.

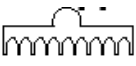
15. Multi-Surface Floor Tool - May be used on both carpets/rugs or hard floor surfaces. For use on carpets, make sure the tab is in the down position  . This will hide the soft outer brushes. For hard floor surfaces, press the opposite tab in the down position  . This will engage the soft outer brushes.

16. Wet Pickup Squeegee Floor Tool – May be used to vacuum hard floor surfaces. Also is used to vacuum up wet spills or mop and scrub your floor with and suck up the dirty water. For example – in the winter time, you drive your car into the garage and because it was snowing outside, the snow drops to the floor and creates wet puddles. Simply take this floor tool and quickly suck up the dirty water in a matter of seconds. For mopping or cleaning your floor you could tilt the brush forward so the nylon scrub brushes are making contact and scrub your floor. Then bring the brush back to its normal level and suck all the dirty water and dirt into the vacuum.

17. Crevice Tool – used to vacuum in small tight spaces like between seats, cushions or window tracks.

18. Dusting Brush – used for dusting and cleaning table-type surfaces.

19. Upholstery Tool – used to vacuum upholstery couches, cushions, car seats and floor mats.

20. Extraction Shampooer Suction Tool – used to vacuum up small wet spills and can also be used to shampoo your car interior (see shampooing section below).

21. 3 Sizes of Detailing & Inflator Tools – these 3 different sizes of inflator or blowing tools can be used to inflate mattresses or detailing to blow dirt out of small hard-to-reach surfaces.

22. Long Detailing Precision Blower Tool – blower detailing tool with long skinny reach for those hard-to-reach places.

23. Wall Mounting Bracket – allows you to mount your vacuum on a wall surface.

24. Screws – wall mounting screws.

25. Mini Head with Spinning Brushroll – this tool has many uses. This is a tool about 5 inches wide with suction and a spinning brushroll. It can be used to vacuum upholstery, car seats, throw rugs, upholstery couches, carpet, stairs and hard-to-reach places. It especially works well for pet hair pickup or where you need more scrubbing power. It may also be used for scrubbing action in shampooing upholstery (see shampooing instructions below).

26. Suds Gun Sprayer Washer – when attached to the hose on the blowing side the suds gun may be used to wash objects or to shampoo upholstery. Plain water may be used in it or any cleaning chemical like standard shampooer extraction chemical. It sprays water or other chemicals simply by holding your finger over the hole.

HOW TO SHAMPOO UPHOLSTERY

You may shampoo on upholstery surfaces (like upholstery seats in your car--follow your car's manufacturer guidelines for shampooing) with the Prolux Wet Dry vacuum by following the instructions below:

1. Attach the hose to the blow or exhaust side of the vacuum.
2. Attach the Suds Gun Sprayer tool (#26) to the hose. Fill the Suds Gun with water and the right amount of correct extraction shampoo (available at most stores).
3. Spray the surface to be cleaned.
4. Connect the hose to the suction side of the vacuum.
5. Use extraction tool #20 to scrub your surface and suck out the dirty water. For more scrubbing power you may also use the mini head tool #25. The extraction tool #20 will suck the most water out.

Then you're done and that is how you shampoo your upholstery surfaces with the Prolux Wet Dry Garage vacuum.

Cleaning and Maintenance

Unit cleaning:

Follow the steps below to get your HEPA filter, cloth filter and copper probe poles cleaned.



A. Remove the dust bucket



B. Take out the dirt tank and empty it.



C. Unscrew and take out the cloth filter

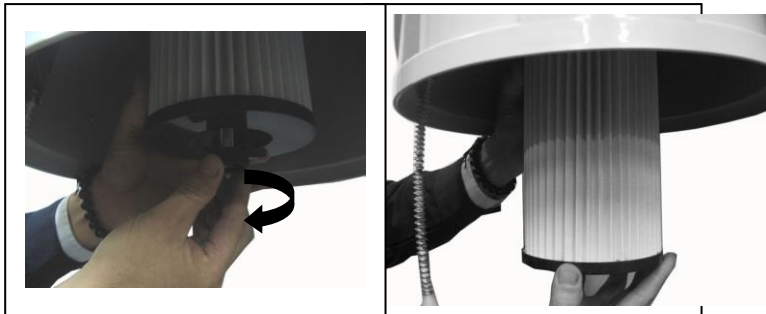

D. Unscrew and take out the HEPA filter

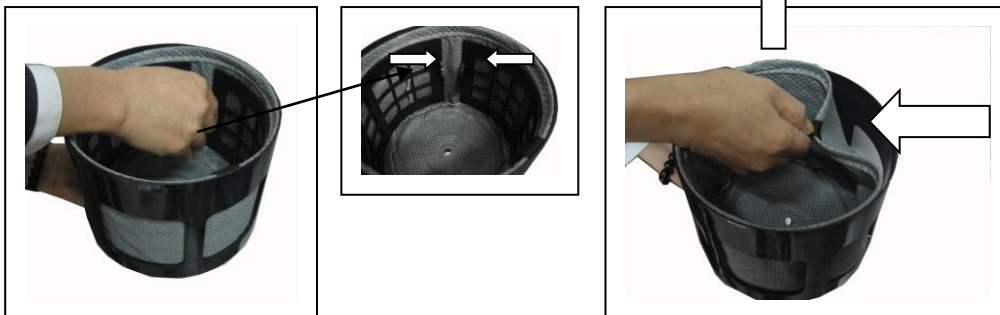

E. Take out the cloth filter by squeezing the plastic cloth filter holder



F: Wash the HEPA filter and cloth filter.

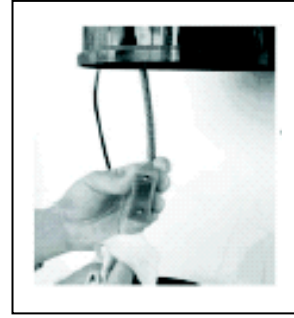

G: Clean the two copper poles of the probe

Filter Maintenance:

From ordinary use the HEPA should be replaced once every year or when yellow light comes on (and dirt bin is clean). Replacing the HEPA filter does improve suction performance.

Cleaning clogs:

Low suction or poor pickup may be due to a clog in the vacuum. If this occurs, the LED full dirt tank indicator light will turn yellow and indicate airflow is restricted.

If there is no suction or if suction is reduced at the hose, follow these steps to clear the clog:

1. Unplug vacuum from electrical outlet.
2. Check the filter and clean as necessary (see unit cleaning above).
3. Check to see if dirt tank is full. Empty if needed.
4. Check wet/dry or blower outlet for clogs.

If the clog is contained near the top of the hose (close to the unit), follow these steps:

1. Attach hose to the wet/dry inlet and turn the power on.
2. This should dislodge the clog by sucking in debris.

If the clog is contained near the bottom of the hose (close to where tools are attached), follow these steps:

1. Remove wand or tool.
2. Attach hose to the blower outlet and turn the power on.
3. This should dislodge the clog by blowing out debris.

If the above methods are not successful, find the clog by hand, then squeeze the hose and shake until the debris dislodges.

Troubleshooting

1) Limited suction power:

If you find the suction power is limited or not working to capacity, follow the steps below to fix:

- a. First check the dust tank. Clean the filter and empty the dust tank.
- b. After cleaning, if problem persists check for clogs.
- c. If problem continues and there is no clog, replace HEPA filter.

2) If appliance fails to start:

- a. Pull out the plug and wait for 60 minutes.
- b. Check electrical outlet to ensure power to the source.
- c. Turn on the power switch.

3) Low suction and/or clog:

- a. Please read section “cleaning clogs” above in the owners manual as well as #1 above.
- b. You may also use your hand to open and close suction. Increase the airflow on the hole blocked--this may cause the object to be sucked in. Or, use a hanger to dislodge the object.

Additional Parts that may be purchased from Prolux

Turbo Head for carpet cleaning -



HEPA Filter & Cloth Filter –



Replacement hose, extension wands, floor tools, crevice tool, duster tool, upholstery tool, mini head, sprayer etc., may also be purchased additionally.

Technical Data

Motor Size	12 AMPS	Rated voltage	120V
Rated frequency	60Hz		
Power	107 CPM	Color	White
Reservoir volume	5.3 Gallons	Noise	≤72dB
Unit Dimensions	32 x 35 x 80 CM		

THREE (3) YEAR LIMITED WARRANTY

Prolux warrants this product free from defects in material and workmanship for a period of three (3) years from the date of the original purchase, when utilized for normal household use, subject to the following conditions, exclusions, and exceptions:

If your appliance fails to operate properly while in use under normal household conditions within the warranty period, please contact your authorized Prolux dealer you purchased the unit from. You may also contact Prolux at the address below. Non-durable parts including, without limitation, filters, accessories, brushes, belts, and electrical parts, which normally require replacement, are specifically excluded from warranty.

This warranty is limited solely to the cost of the repair or replacement of the unit at our option. This warranty does not cover normal wear of parts and does not apply to any unit that has been tampered with or used for commercial purposes. This limited warranty does not cover damage caused by misuse, abuse, negligent handling, or damage due to faulty packaging or mishandling in transit. This warranty does not cover damage or defects caused by or resulting from damages from shipping or repair, service or alterations to the product or any of its parts, which have been performed by a repairperson not authorized by Prolux.

This warranty is extended to the original purchaser of the unit. It excludes all other legal and/or conventional warranties. In no event, is Prolux or its dealers liable for incidental or consequential damages of any nature whatsoever. Some states do not permit the exclusion or limitation of incidental or consequential damages, so the above may not apply to you.

***IMPORTANT: Before sending unit back for warranty work contact your authorized Prolux retailer you bought the unit from first. Unauthorized warranty claims may be sent back. Authorized Warranty claims: Prolux shall be responsible for all parts and labor and the customer shall be responsible for all shipping charges to and from the Prolux service center.**

We are constantly striving to improve our products. Therefore, the specifications contained herein are subject to change without notice.

Contact Information for Prolux is service@proluxcleaners.com

For your records:

Please record your Model Number: _____

Please record your Purchase Date: _____

Note: Please keep your original sales receipt. It provides proof of purchase date in the event of a warranty claim.

Prolux.....High-End Cleaners that Work!