



**RR1
(CRBR-2412)**



Use & Care Instructions

TABLE OF CONTENTS

1. Welcome to iio	page 2	7. Energy saving tips	page 18
2. Product overview	page 3	8. Cleaning	page 19
3. Important safety notes	page 4	9. Troubleshooting	page 21
4. Installation	page 6	10. Warranty	page 22
5. Product dimensions	page 8	11. Your appliance information	page 23
6. Operation	page 10		

WELCOME TO iio!

Congratulations and thank you for your purchase! We truly appreciate your business and are grateful for the trust you have placed in us and our products.

You have purchased one of the most efficient refrigeration products available today. We are proud of this beautifully designed refrigerator and believe it will bring you years of reliable service.

At iio, we design our appliances for both space and energy efficiency. Our mission is to create a range of stylish home appliances that fit your life, your style, space parameters, taste, eco aspirations, functional needs, budget and way of shopping. We want to help turn any space where you live, into a home.

Please register your refrigerator at www.iioKitchen.com.

For any inquiries, please contact us at: 1-833-446-4461 or visit www.iioKitchen.com for additional information regarding your appliance.

Extend your warranty today!

- Receive up to 1 month of [extended warranty](#) for submitting a photo and 2 months of extended warranty by submitting a video (pending review).

To be considered for approval:

- Photo upload must demonstrate the product's use or application in a natural setting, and should clearly show the product from a perspective not already shown on the site.
- Video review must be at least 30 seconds in duration, clearly show the product in use in a natural setting, and include insightful product-specific audio commentary.
- The photo or video must be of sufficient quality, in the opinion of the iio™ management, that it can be used on our website and in other promotional materials.
- Submitting the photo and video represents your permission that we may have unlimited use of these materials wherever we require, at no additional cost.

PRODUCT OVERVIEW

- The images in this guide may differ from the actual components and accessories, which are subject to change without prior notice for product improvement purposes.

Note: The appearance of components of the appliance may differ from model to model.

- The refrigerator is intended for storing fresh food at temperatures above 32° F (0° C).
- Appliance temperature may be changed by adjusting the control panel settings.
- The freezer section is intended for freezing fresh and already frozen food and for long-term storage. Length of storage time is dependent on the type of food being stored.

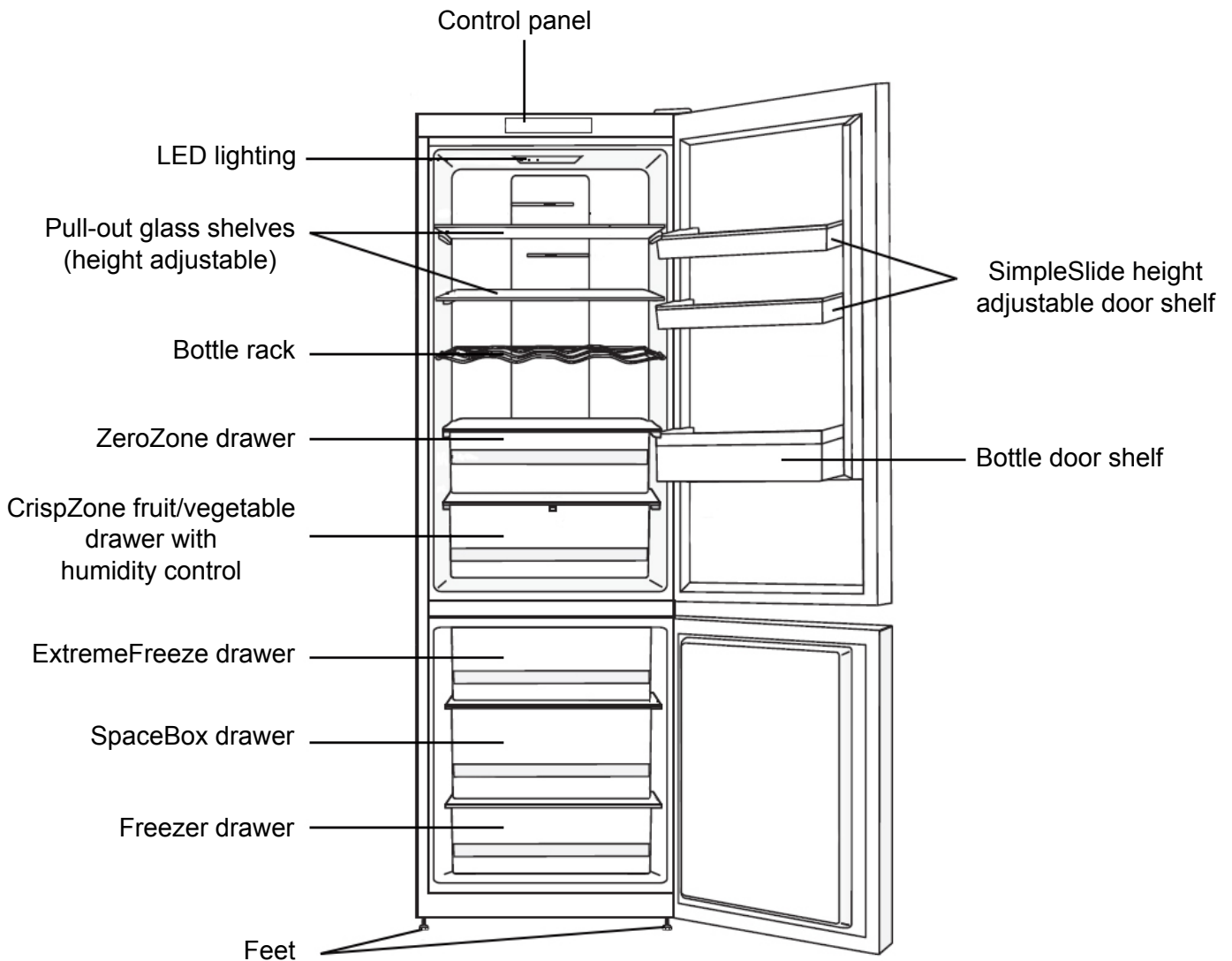

IMPORTANT SAFETY NOTES

Always read and follow all safety messages.

READ ALL INSTRUCTIONS BEFORE USE.



Alert Symbol – will display **WARNING** or **CAUTION** beside the instruction. Messages with the Alert Symbol will inform you of the potential hazard, provide guidance for reducing the hazard, and inform of the possible outcome if the instruction is not followed.

WARNING – YOU MAY BE KILLED, SERIOUSLY INJURED OR DAMAGE THE APPLIANCE IF THE INSTRUCTION IS NOT FOLLOWED.

CAUTION – YOU MAY BE INJURED OR DAMAGE THE APPLIANCE IF THE INSTRUCTION IS NOT FOLLOWED.



WARNING

- Flammable refrigerant used. To be repaired by trained service personnel only. Do not puncture refrigerant tubing or other parts that use refrigerant. Consult user manual before attempting any repairs. All safety precautions must be followed.
- When using this appliance follow basic precautions to reduce the risk of electrical shock, explosion, fire, serious injury or death.
- Do not put flammable, explosive, volatile and highly corrosive items in the appliance to prevent damage to the appliance and prevent injury or death. Keep materials and vapors, such as gasoline and alcohol, away from appliance.
- Use non-flammable cleaner to clean the appliance.
- Do not use electrical appliances (i.e. hair dryer or fan) inside the appliance compartments.
- Disconnect the power before servicing or cleaning.



- This appliance is not intended to be used by children under the age of 8.
- Children shall not play with the appliance. Do not allow any child to get into, climb the appliance or play with the appliance doors.
- Do not allow children to play in, on or around the fridge. It is not a toy. THERE IS A DANGER OF SUFFOCATION IF A CHILD BECOMES TRAPPED INSIDE.
- When the appliance is not in use, secure or remove the doors to prevent children from playing inside the cabinets.
- Risk of child entrapment. Before throwing away an old appliance remove the door(s), remove the shelves to prevent children from climbing inside.
- This appliance is not intended for use by persons (including children) whose physical, sensory or mental capabilities may be different or reduced, or who lack experience or knowledge, unless such persons receive supervision or training to operate the appliance by a person responsible for their safety.
- Cleaning and user maintenance shall not be made by children without supervision.



CAUTION

- **DO NOT OPEN THE DOOR MORE THAN 120° AS THIS WILL DAMAGE THE DOOR**
- Appliance **MUST** be in a vertical position for 24 hours before being connected to power.
- Replace all appliance parts and panels before operation.
- To avoid injury two or more people are required to move and install the appliance.

Prop. 65 Warning for California Residents



WARNING: This product may contain chemicals known to the State of California to cause cancer, birth defects, or other reproductive harm.



Dispose of properly in accordance with federal and/or local regulations. In case of punctured tubing follow all handling instructions carefully.

INSTALLATION



WARNING

- When using this appliance follow basic precautions to reduce the risk of electrical shock, explosion, fire, serious injury or death.
- Only connect this product to a dedicated grounded electrical outlet rated for use with this product (110-125V, 60Hz, AC only). It is the user's responsibility to replace a standard 2-prong wall outlet with a standard 3-prong (grounded) wall outlet. Ensure that the grounding electrode is equipped with a reliable grounding line.
- Do not damage the refrigerant circuit.
- Never attempt to operate this appliance if it is damaged, malfunctioning, partially disassembled, or has missing or broken parts, including a damaged cord or plug.
- Do not remove the ground prong from the power cord.
- Do not use an extension cord.
- Do not use an adapter on the wall socket.
- Do not pull out plug using the power cord. Firmly grasp the plug and pull it out from the socket.
- When moving the appliance, be careful not to roll, bend, pinch or damage the power cord.
- Do not install the appliance in a damp or dusty place where insulation or electrical parts may deteriorate.
- Do not place electrical appliances on top of the appliance.
- Keep packing materials out of the reach of children. Packaging material can be dangerous for children as there is a risk of suffocation.
- Do not place the appliance in direct sunlight or expose it to the heat from heating appliances such as stoves or heaters.
- Do not place heavy objects on top of the appliance as they may fall and cause injury when the appliance door is opened.
- Do not use sharp instruments, rubbing alcohol, flammable fluids, or abrasive cleaners to remove tape or glue. These products can damage the surface of your appliance.



CAUTION

- Do not use an outlet that can be turned off with a switch.
- Appliance **MUST** be in a vertical position for 24 hours before being connected to the power outlet.
- Install the appliance in a dry and well ventilated room. Ambient temperature should be between 18 °C ~ 38 °C (64 °F ~ 100 °F).
- To avoid injury or damage to the appliance, installation should be carried out by two people.
- The appliance is heavy. Protect the floor when moving the appliance for cleaning or servicing.
- Always pull the appliance straight out when moving it. Do not wiggle or walk the appliance as floor damage could occur.
- Keep ventilation openings clear of obstructions.
- Never pick up or move the refrigerator by the door.



Remove the Packaging

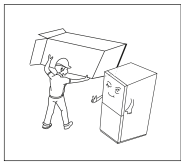

- Remove tape and any temporary labels from your refrigerator before use. Do not remove any warning labels, the model and serial number labels, or the circuit diagram from the appliance as this will void the warranty.
- Carefully remove the protective plastic film on the doors and refrigerator body.
- If required, carefully use tweezers or other small instruments to start the peeling at the corners.

Appliance Location

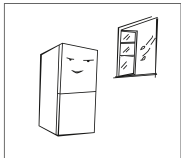
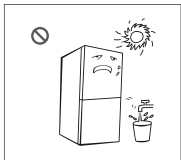

- To avoid noise and vibration, the appliance must be installed and leveled on a solidly constructed floor. If required, adjust the leveling legs to compensate for the unevenness of the floor.
- Keep away from heat and avoid direct sunlight.
- Do not place the appliance in humid or watery places to prevent corrosion or reduced insulation efficiency.
- Ensure that the appliance is placed in a well-ventilated indoor location.
- Ensure that there is enough space around the appliance, as indicated in diagram (pg. 8), to allow for proper ventilation.

Note: Installation on carpeting, soft tile surfaces, a platform or weakly supported structure is not recommended. Surface shall be flat and sturdy (rotate left and right to adjust the wheel for levelling if unsteady).

PRODUCT DIMENSIONS

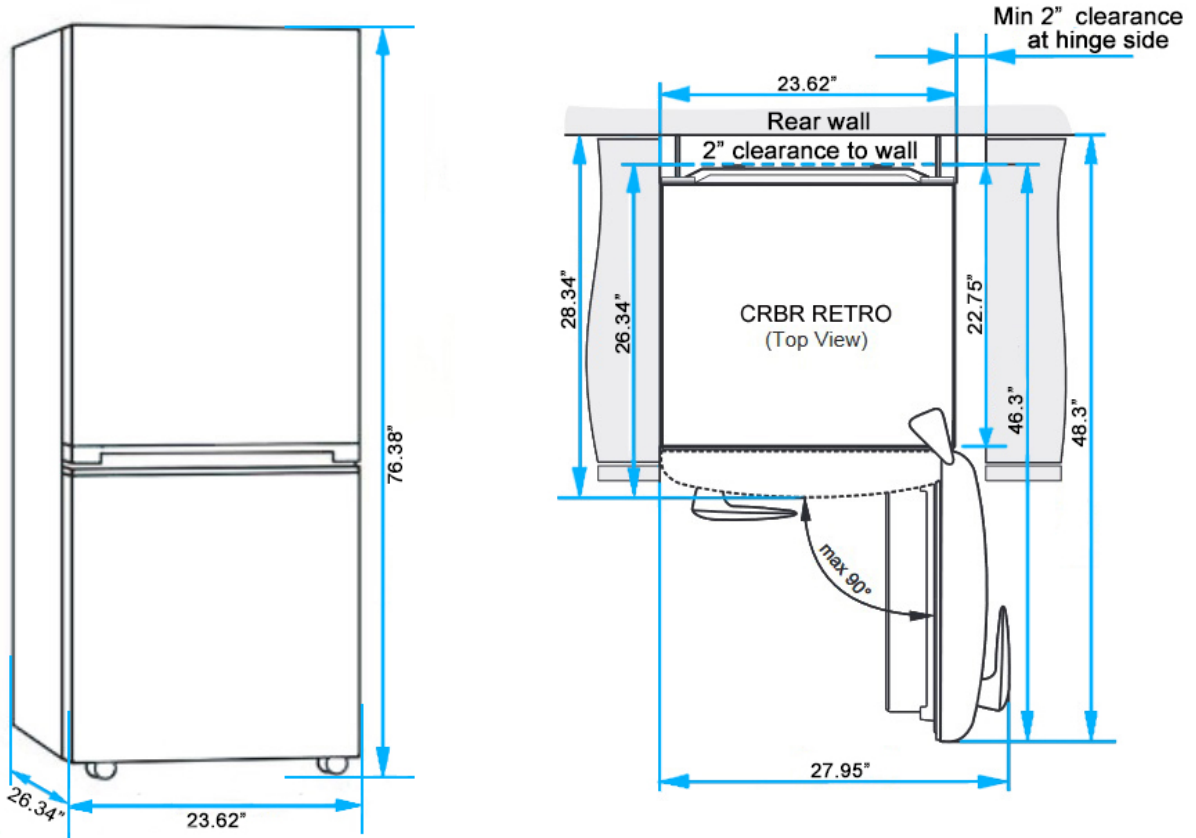

- Your refrigerator should be installed on a flat and even floor. Keep the refrigerator level by adjusting the front leg levers.

Dimensions and Clearances

- Check the dimensions of the appliance and the installation path to ensure there is sufficient room to move the appliance through doors or narrow openings.
- The installation location chosen for the appliance should allow space behind the unit for connections and airflow as well as space in front to open the doors.
- Too small of a distance from adjacent items may result in reduced cooling and freezing capability and increased power consumption. Allow at least 21" inches in front of the appliance to open the door, and at least 2" clearance between the back of the appliance, sides and wall.

Levelling

- The refrigerator has two front leveling legs. Adjust the legs to alter the tilt from front-to back or side-to side. If the refrigerator seems unsteady, or the doors do not close easily, adjust the refrigerator's tilt using the instructions below:
 1. Turn the leveling leg counterclockwise to raise that side of the refrigerator or clockwise to lower it. It may take several turns of the leveling leg to adjust the height of the appliance.
 2. Open the door and check to make sure that it closes easily. If the door does not close easily, tilt the refrigerator slightly more to the rear by turning both leveling legs counterclockwise. It may take several more turns.

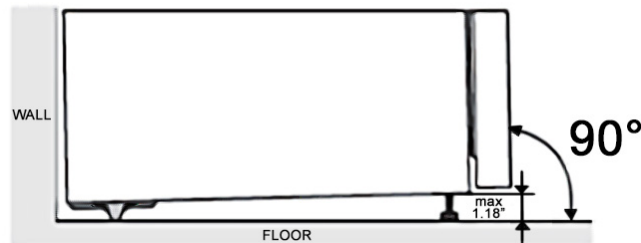

Positioning the Refrigerator

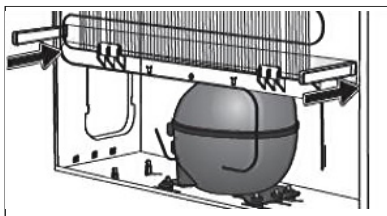

- Arrange the refrigerator so that it does not vibrate against adjoining surfaces or against the wall. Be sure to maintain a 2" clearance between the back and hinge side of the appliance.
- Appliance is supplied with two spacers which should be installed on the lower part of the housing to prevent pushing the appliance too close to the wall. The appliance may also be installed without the spacers; however, this may increase power consumption.

OPERATION

Before Use



WARNING

- If the refrigerator is unplugged, turned off or has lost power, you must wait 3 to 5 minutes before restarting the unit. If you attempt to restart before this time delay, the refrigerator will not start.



CAUTION

- **DO NOT OPEN THE DOOR MORE THAN 120° AS THIS WILL DAMAGE THE DOOR.**
- Do not scratch the appliance with a sharp object or use a detergent that contains alcohol, a flammable liquid or an abrasive when removing any tape or adhesive from the appliance.



- Do not peel off the model or serial number label or the wiring diagram on the rear surface of the appliance as this will void the warranty.
- Open appliance doors to ventilate the interior as the appliance may have a "new car smell".
- Clean the appliance thoroughly by wiping off all surfaces with a soft cloth and mild detergent.



- The appliance may make a loud noise after initial operation. This is normal and will decrease as the temperature decreases.
- Remove any adhesive tape from inside the appliance and open the doors for ventilation.

Digital AdapTech Control

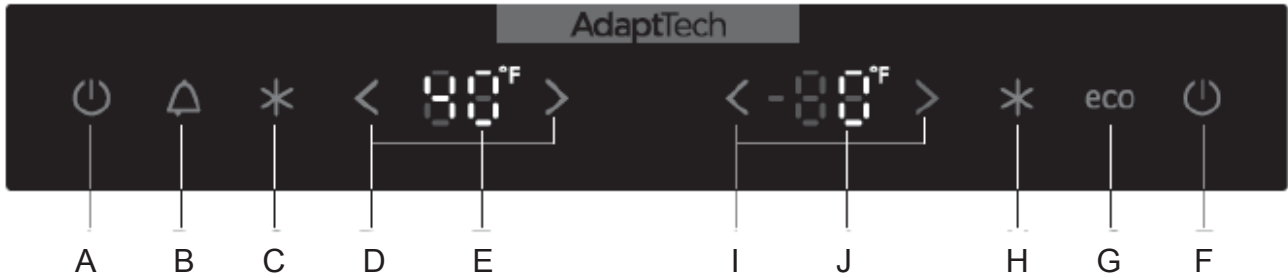

A – Appliance On/Off key	F – Freezer On/Off key
B – Acoustic alarm Off key	G – Eco function On/Off key
C – Super Cool On/Off key	H – SuperFreeze On/Off key
D – Refrigerator temperature adjustment keys (< Down, > Up)	I – Freezer temperature adjustment keys (< Down, > Up)
E – Refrigerator temperature display	J – Freezer temperature display

Switching the Appliance On

- Switch on the appliance by briefly pressing the **A** key.
- It is possible to switch On the freezer compartment while the refrigerator compartment is switched Off.
- There are two ways of doing so:
 - Briefly press the **F** key to switch On the freezer compartment only; or,
 - First briefly press the **A** key to switch on the entire appliance, then press and hold the **A** key for three (3) seconds to switch Off the refrigerator compartment.
- Pressing the **A** key again will turn On the refrigerator compartment.

Switching the Appliance Off



CAUTION

- Even when switched Off, the appliance will remain powered – there will still be electrical current in the appliance.
- Press and hold the **F** key for three (3) seconds to switch off the appliance.

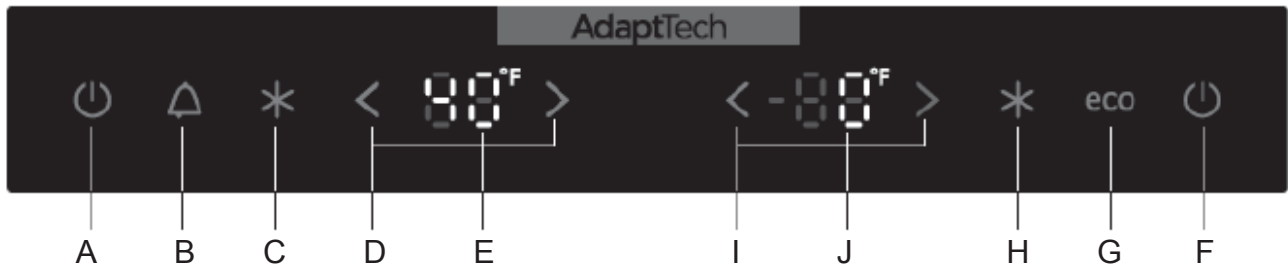

Adjusting the Refrigerator Temperature

- To set the temperature in the refrigerator compartment use the **D** key. Pressing the < key will lower the temperature. Pressing the > key will raise the temperature.
- Temperature in the refrigerator compartment can be set from +34°F to +46°F.
- Press one of the **D** keys to set the refrigerator to the desired temperature. Release the **D** key once the desired temperature has been reached. The temperature setting will flash on the display (**E**) and will be set after three seconds.
- Recommended setting is 40°F.

Refrigerator Boost (Super Cooling)

- Use this setting after switching On the appliance for the first time, before cleaning, or before inserting a large amount of food.
- To turn this feature On, press the **C** key.
- If the function is not deactivated manually it will be deactivated automatically after approximately six (6) hours and the refrigerator compartment temperature will return to the last setting.

Adjusting the Freezer Temperature

- To set the temperature in the freezer compartment use the **I** key. Pressing the < key will lower the temperature. Pressing the > key will raise the temperature.
- Temperature in the freezer compartment can be set from -6°F to +6°F.
- Press one of the **I** keys to set the freezer to the desired temperature. Release the **I** key once the desired temperature has been reached. The temperature setting will flash on the display (**J**) and will be set after three seconds.
- Recommended setting is 0°F.

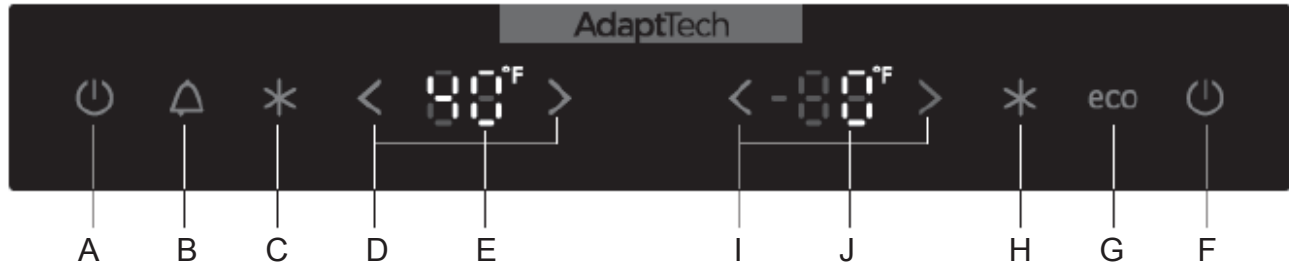

Freezer Boost Function (ExtremeFreeze)

- Use this setting after switching On the appliance for the first time, before cleaning, or 24 hours before inserting a large amount of food.
- After this time, insert the fresh food into the freezer compartment.
- Avoid placing fresh food in contact with already frozen food.
- The recommended location for freezing large amounts of food is in the upper section of the freezer.
- After 24 hours in the upper section of the freezer the food may be moved to a lower section of the freezer compartment.
- Press the **H** key. **FF** will appear on the display (**J**).
- If the freezer boost is not deactivated manually it will be automatically switched Off after approximately 2 days, after which the temperature of the freezer compartment will return to the last setting.

Open Refrigerator Door Alarm

- If the refrigerator or freezer compartment door is open for more than two (2) minutes an acoustic alarm will be activated and the **B** key will flash. Once the door is closed, the alarm will be deactivated. The alarm can also be switched Off by pressing the **B** key.

ECO Function

- During periods of less frequent use (door opening) or absence from home, such as vacation, Eco program can provide optimum temperature while saving power.
- To activate the ECO function, press the **G** key. With this function activated the appliance will operate with optimal settings.

Child Safety Lock Function

- Use this function if you wish to lock out the appliance settings. Temperature adjustments are deactivated when the appliance is in this mode.
- To activate, press and hold the **B** key for three (3) seconds. **LL** will appear on the display (**E**).
- This will lock all keys except for the **B** key.
- To deactivate the safety lock, press the **B** key for three (3) seconds.

INTERNAL COMPONENTS

(may differ from model to model)

Glass Shelves



CAUTION

- Before moving a shelf ensure that you remove the contents from the shelf first.

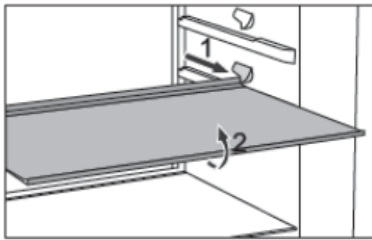

- Shelves can be partially pulled forward and allow for easier access to food.
- Several shelf positions are available, allowing the shelves to be easily repositioned.
- To remove and reposition a shelf gently pull it straight out to the point where it is stopped by the guide (1).
- Slightly lift the shelf up from the front and pull it completely out (2).
- Gently re-install the shelf at the desired position by reversing these steps.

Wire Bottle Rack

- The bottle rack may be used for holding bottles and cans and can be repositioned in the appliance.



CAUTION

- When placing bottles or cans on the rack ensure that their total weight does not exceed 25 lbs.
- Before moving the bottle rack ensure that you remove the contents from the rack first.

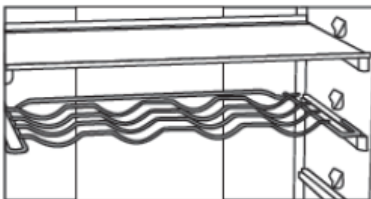

- The rack is seated in slots at the back.
- To pull it out, slightly lift it gently from the back, until it has cleared the slots at the back, and pull it straight out to completely remove it.
- Gently re-install the rack at the desired position, ensuring that it is properly seated in the slots at the back of the appliance.
- When placing the bottles on the rack ensure that the length of the bottles do not prevent proper closing of the door.

Refrigerator and Freezer Drawers

- The refrigerator and freezer drawers may be removed for cleaning.

ZeroZone Drawer

- The ZeroZone drawer allows food to stay fresh longer and retain more flavor & nutrients than in a conventional refrigerator.
- The drawer should be fully closed for optimal performance.
- When buying food, make sure it is fresh as this will determine the quality of the food as well as how long it will keep in the appliance.
- Store the food in closed containers or appropriate packaging to prevent it from emitting or absorbing odors.
- Take the food out of the appliance 30-60 minutes to allow its aroma and flavor to develop at room temperature.
- Foods sensitive to low temperatures include pineapple, banana, avocado, potato, eggplant, cucumber, beans, pepper, melons, squash, etc.

CrispZone Drawer (Fruit and Vegetable Drawer with Humidity Control)

- The bin at the bottom of the refrigerator compartment is intended for storing fruit and vegetables. It provides humidity and prevents the food from drying out.
- Store the food in suitable packaging to prevent it from emitting or taking on odors. The bin has integrated sliding humidity regulator which allows setting the humidity level according to the amount of food stored.

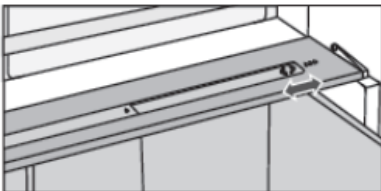

- For smaller amounts of food push the control slider to the right.
- For larger amounts of food push the control slider to the left.



CAUTION

- To avoid damage, especially to the freezer drawers due to cold temperatures, ensure that you gently grasp the drawer from the bottom portion only.
- Before removing the drawers ensure that they have been emptied of their contents.

ZeroZone Drawer

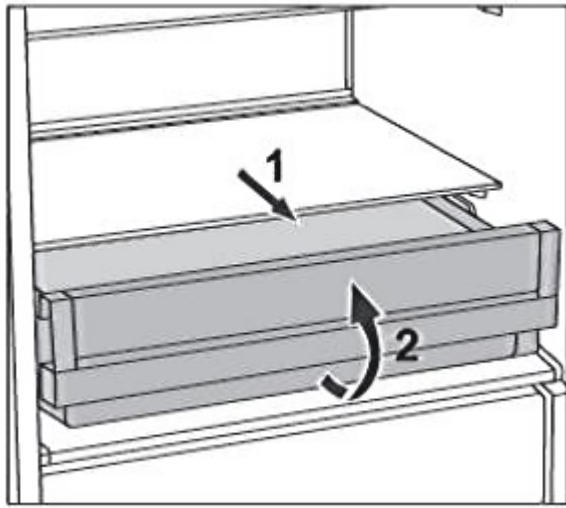

CrispZone Drawer

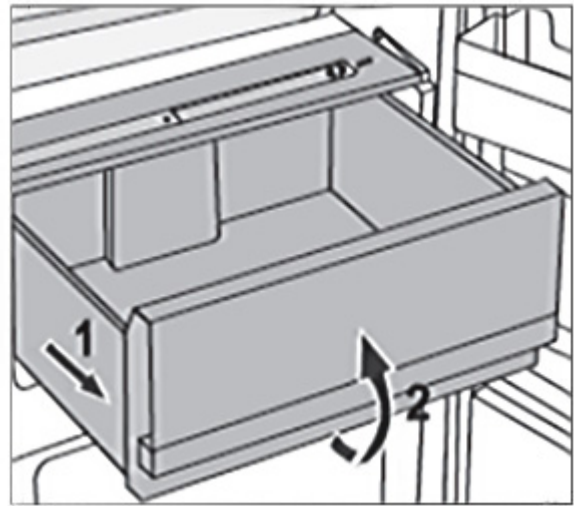

- Gently pull out the drawer straight out until touches the drawer stops (1).
- Lift the front part of the drawer and gently pull it out completely (2).
- Re-install the drawer by reversing these steps.

Door Shelves

- The door shelves are mounted on the refrigerator door and are intended for storing smaller food items like cheese, butter, bottles, etc. There is a bottle shelf at the lower section of the door.

SimpleSlide door shelf

- There are two SimpleSlide door shelves for which the height can be adjusted to your preferences without having to take them out of the appliance.

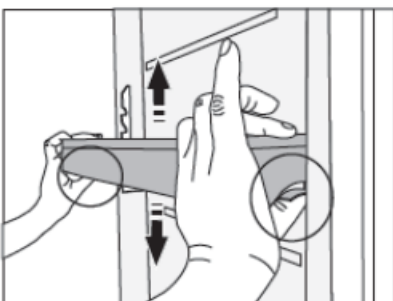

- Using both hands at opposite sides of the shelf, gently squeeze the tabs on both sides at the same time to move the shelf up or down.
- To completely remove the shelf raise it up evenly and horizontally past the positioning slots and pull it straight out.
- Re-install the shelf by reversing this step.
- Ensure that it is lowered evenly and horizontally.
- As when adjusting the shelf height, you will need to squeeze the tabs to move the shelf to a lower position.

MultiBox Storage Bin

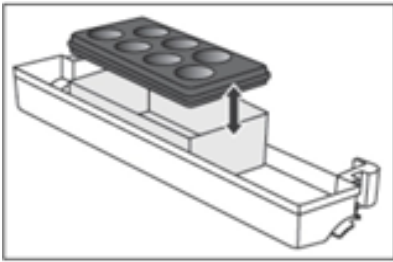

- The MultiBox bin offers a convenient way for storing food with strong odors such as cheese and onions.
- The silicone lid provides an air-tight seal that prevents the food from drying out and the odor to spread throughout the refrigerator compartment.
- The silicone lid can also be used as an egg or ice tray.
- If the flexible lid is used as an egg tray, it is recommended to place it directly on the bottom of the door bin and use the open lower part of the MultiBox bin to store food in small packages.

Defrosting the Appliance

- The appliance and occasional frost on appliance surfaces will defrost automatically.
- The freezer may occasionally have a buildup of ice. This is dependent on a variety of reasons such as frequent opening of the door, humidity levels or seasonal changes. The appliance may need to be defrosted from time to time.
- If defrosting is required disconnect the appliance from the power supply and gently wipe down surfaces with a dry cloth. Place a towel in the appliance to collect any excess water.

ENERGY SAVINGS TIPS

- Do not install the fridge close to sources of heat, such as a stove, boiler, heater, chimney, etc, and avoid exposure of the appliance to direct sunlight.
- Locate the appliance in a cool well-ventilated room and make sure that the air vents of the compressor housing cover are not obstructed. Also allow adequate spacing around the cabinet for air circulation (2”).
- Avoid unnecessary frosting in the cabinet by packing all food and liquids in airtight packages or containers.
- Always keep food stored in tightly sealed packaging or containers, and allow some space for air to circulate around each item.
- Avoid keeping the door open for extended periods of time or opening the door too frequently as warm air will enter the cabinet and cause the compressor to run unnecessarily.
- Ensure there are no obstructions preventing the doors from closing properly and forming a tight seal.

CLEANING



WARNING

- Unplug the appliance from the power source before cleaning.
- Do not use large amounts of water or liquid when cleaning the appliance as this may affect electrical components and insulating properties of the appliance.



CAUTION

- Do not use any detergents or flammable substances such as alcohol, thinner, bleach, or other flammable liquids to clean the appliance.
- Cleaning solutions that contain abrasives, acids or solvents are not suitable for cleaning and may damage the fridge and cause discoloration. Do not use these types of cleaners.
- Do not use sharp objects when cleaning the appliance as these may scratch the appliance.
- Do not peel off or damage the model or serial number labels on the surfaces of the appliance as this will void the warranty.
- Exercise care when moving shelves, drawers, and door shelves to avoid breakage.
- Regular cleaning of the appliance is recommended to prevent odors and ensure efficient operation of the unit. This includes interior surfaces such as interior walls, shelves, and door shelves as well as exterior components such as door gaskets, handles, sides, and the condenser unit.
- Use a soft damp cloth with mild detergent to clean all surfaces.
- Removable parts such as shelves, drawers and door shelves may be taken out for cleaning.
- Wipe up spills immediately.
- Surfaces should be dried after being wiped.

Exterior Cleaning

- Check and clean the door gasket regularly to ensure that there is no debris on it.

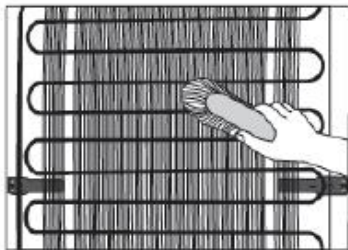

- Exterior surfaces of the appliance can also be cleaned with a soft damp cloth with mild detergent.
- Periodically clean the dust that accumulates under and behind the appliance to improve the cooling efficiency.
- The condenser unit should always be kept clean and free of dust or deposits. It can be cleaned by using a soft non-metallic brush or vacuum cleaner.

Compressor Cavity



WARNING

- Turn off the appliance and unplug the appliance from the power source before attempting to clean the compressor cavity.
- Take extreme care when cleaning this section of the appliance as it contains electrical and mechanical components as well as delicate refrigerant tubes that must not be damaged.

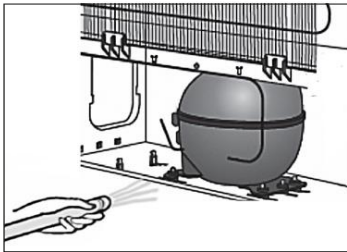

- The compressor cavity area can be cleaned with a vacuum equipped with a soft brush or crevice tool.
- Gently vacuum the dust that has accumulated in this area.

TROUBLESHOOTING

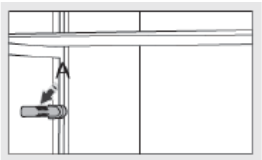
PROBLEM	POSSIBLE CAUSE OR REMEDY
Appliance is connected but does not work:	<ul style="list-style-type: none"> Ensure that the appliance is plugged in and there is power in the outlet. Confirm that circuit breaker or fuse has not tripped.
Cooling system operates continuously for extended periods of time:	<ul style="list-style-type: none"> Ambient temperature too high. Door opened frequently or for too long. Door not closed properly (misaligned, damaged or dirty door seals). Large load of food added at once. Temperature sensor blocked by food, preventing proper air circulation. Ensure recommended clearances are adhered to. Ensure there is adequate air circulation behind the appliance. <div style="display: flex; align-items: center; margin-top: 10px;">  <ul style="list-style-type: none"> Sensor in the refrigerator (A) blocked by fresh food. Ensure that the air can circulate around the sensor (some models). </div>
Excessive ice build up on the back wall or in the freezer: (Note: some moisture buildup is normal)	<ul style="list-style-type: none"> Door opened too frequently or for too long. Warm food placed in refrigerator. Food placed against back wall of refrigerator. Poor door sealing. Door seal damaged or dirty, replace or clean seal. Extremely humid environment. Door not closed properly or opened excessively.
Door will not close:	<ul style="list-style-type: none"> Check and clean the door gasket regularly to ensure that there is no debris on it.
Door difficult to open:	<ul style="list-style-type: none"> Clean door gaskets and contact surfaces with mild soap and warm water. Add non-slip pads to the refrigerator feet if it is sliding on the floor.
LED lighting does not work:	<ul style="list-style-type: none"> Call a service technician. Do not attempt to repair this yourself as there is danger of making contact with high voltage.

For other troubleshooting inquiries or for an iio™ authorized repair center please contact us at: 1-833-446-4461 or email us at service@iioKitchen.com.

WARRANTY

iio™ warrants all refrigerators will be free from defects in materials or workmanship for a period of TWO YEARS from the date of original purchase.

THERE ARE NO OTHER WARRANTIES, EXPRESSED OR IMPLIED, INCLUDING BUT NOT LIMITED TO, WARRANTIES OR MERCHANTABILITY OR FITNESS FOR A PARTICULAR PURPOSE. Proof of purchase/original invoice may be required to claim warranty. Keep a photocopy easily accessible.

If the home in which the refrigerator is installed is sold within the warranty period, the new owner is protected until the expiration of the original purchaser's warranty. During this two-year period, iio™ will at its option, repair or replace, without charges, any product or part which is found to be defective under normal use and service.

This warranty does not cover:

- a) normal maintenance and service;
- b) any products or parts which have been subject to misuse, negligence, accident, improper maintenance, or repair (except by an authorized iio™ repair center), faulty installation or installation contrary to recommended installation instructions;
- c) cosmetic damage.

iio™ OBLIGATION TO REPAIR OR REPLACE, AT iio™ OPTION, SHALL BE THE PURCHASER'S SOLE AND EXCLUSIVE REMEDY UNDER THIS WARRANTY. iio™ SHALL NOT BE LIABLE FOR INCIDENTAL, CONSEQUENTIAL OR SPECIAL DAMAGES ARISING OUT OF, OR IN CONNECTION WITH, PRODUCT USE OR PERFORMANCE.

This warranty applies only within North America, to refrigerators installed for use for PRIVATE SINGLE FAMILY USE. If used for COMMERCIAL, MULTI-FAMILY USE or any other purpose, the warranty will be voided.

Removal or disfigurement of the serial plate, will void the warranty. The purchaser will be responsible for any extra expenses involved in making the refrigerator readily accessible for servicing. The purchaser will be responsible for any extra charges where the installation is in a remote location such as un-assumed roads, islands, and areas known as cottage country, 20 km outside a Metropolitan area or where a technician is not available. Freight damage is not covered by this warranty.

For a iio™ authorized repair center please contact us at: 1-833-446-4461 or you can visit www.iio.com for more information.

YOUR APPLIANCE INFORMATION

To make it easier to request maintenance or warranty service, please record the following information and keep this manual near your appliance.

Make:	
Model:	
Serial Number:	
Invoice Number:	
Date Purchased:	
Store Name:	

NOTES:



We do the utmost to ensure that the provided information is complete and accurate, however, images and specifications are subject to change without notice.

Visit www.iiookitchen.com to download the latest version of the user manual.