



Eliya



Single Handle Pull-out Kitchen Faucet

STANDARDS

- ASME A112.18.1/CSA B125.1
- ASME A112.18.2/CSA B125.2
- LISTED IAPMO/cUPC

- 1.8 gpm/6.8 L/min

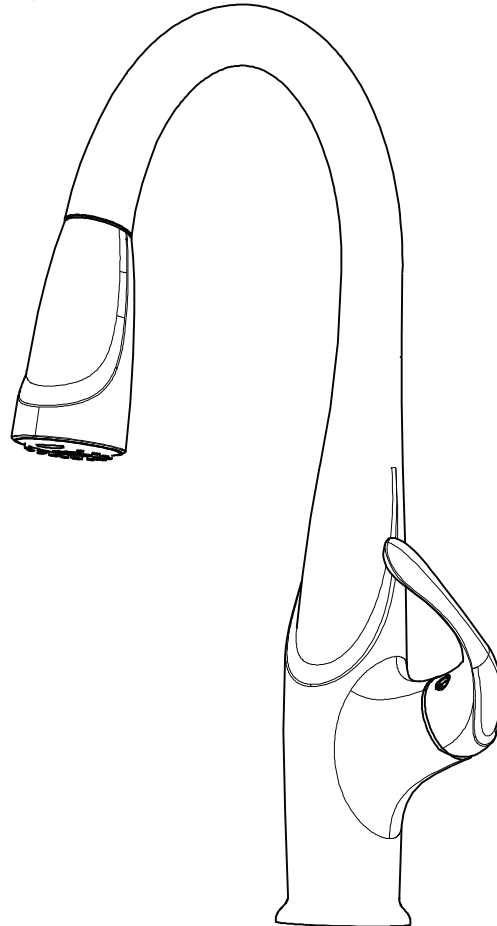

Helpful Information

Tools:

Gather the necessary tools as shown below to complete the installation of this faucet. Some may not be needed depending on the model of faucet you are installing. Check with your local hardware store on the requirements of your installation situation.

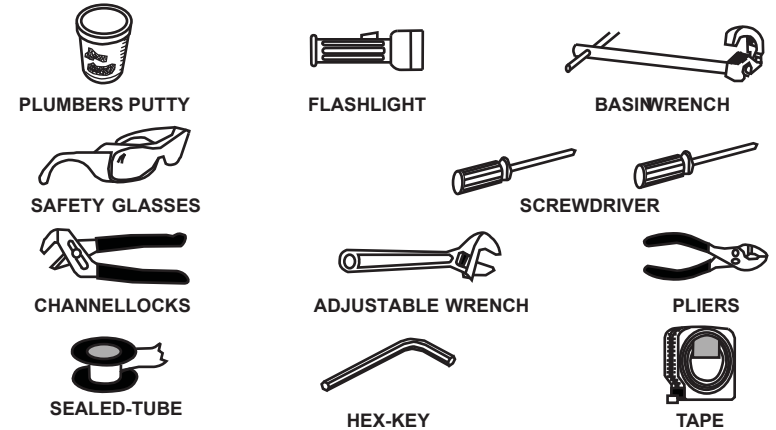

! WARNING:
Please keep the tools for future use!

Attention:

For easy installation, you will need:

- To read all the installation instructions completely before beginning.
- To read all the warning, attention and maintenance information.
- To purchase the proper supply lines.

Important

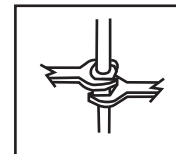

Tighten connection with two wrench to prevent damage to tube body. Be careful not to bend the stem as this will void the product warranty.

Installation size map

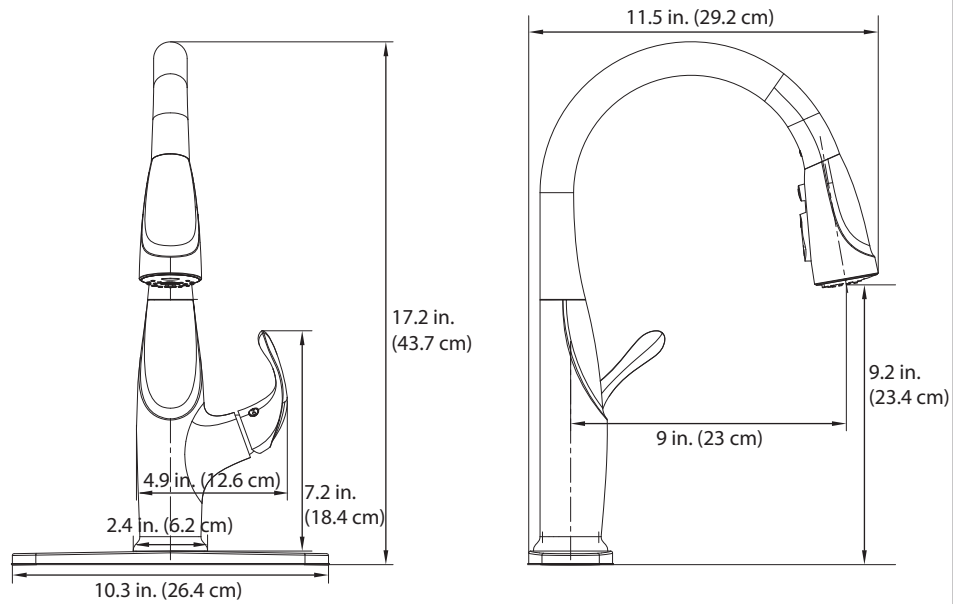

Faucet Installation

1

Make sure sink installation hole is $1 \frac{3}{8}$ inches (3.5 cm).

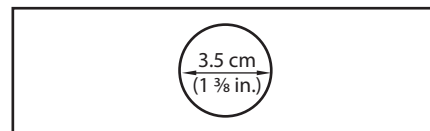

Faucet Installation

2

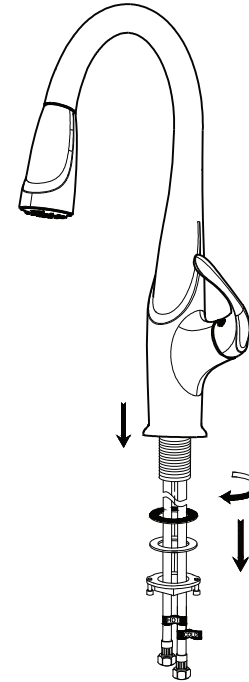

Remove the rubber, metal washers and mounting nut from the base by hand twisting it off.

3

For 1-hole installation, insert the faucet through the hole on the sink.

For 3-hole installation, insert the faucet to the base plate and then through the hole on the sink.

Note: Make sure that the rubber o-ring stays above the mounting surface for 1-hole installation or between the faucet and base plate for 3-hole installation.

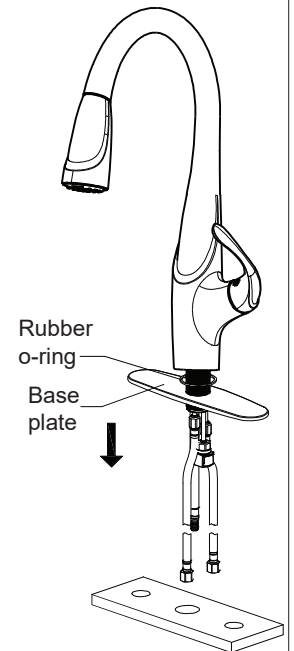
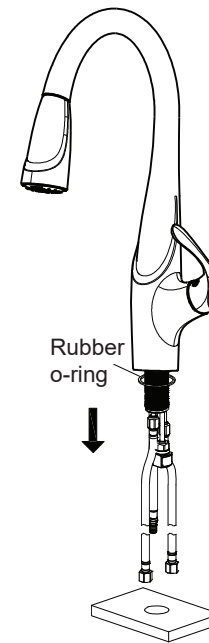

4

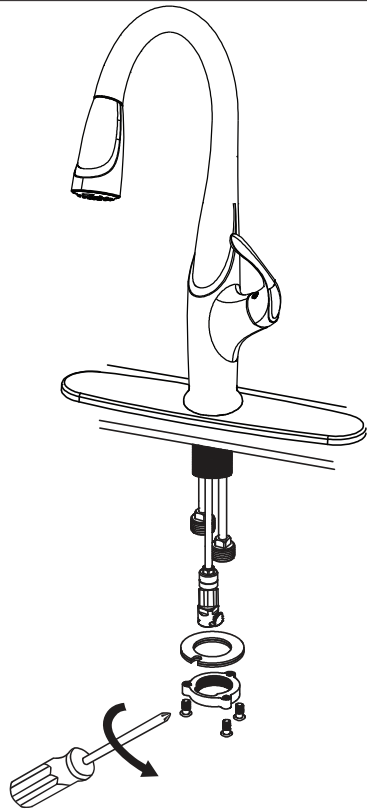

Secure the faucet by firmly hand tightening the rubber washer, metal washer and mounting nut back on the faucet threads underneath the sink.

Tighten the screws on the mounting nut with a Phillips screwdriver.

5

Connect the water supply lines to the hot and cold water valves. Tighten with an adjustable wrench. **Do not overtighten.**

Attention: Make sure that the inlet hoses are not twisted.

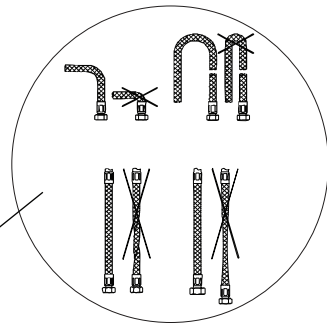

Hot supply hose. Cold supply hose.

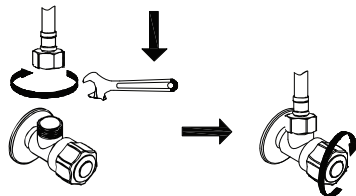

6

The faucet should be flushed for possible debris prior to using. Remove the nozzle head by hand twisting it off. Turn the faucet handle all the way on, turn on the hot and cold water supply and flush water lines for one minute. Re-install the nozzle head by hand twisting back on.

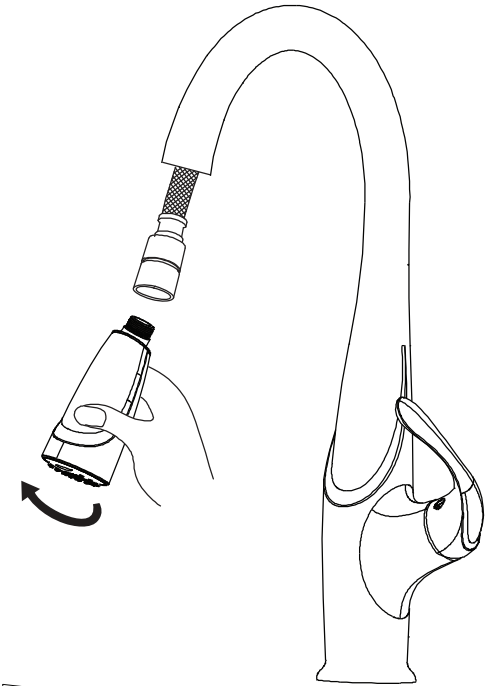

7

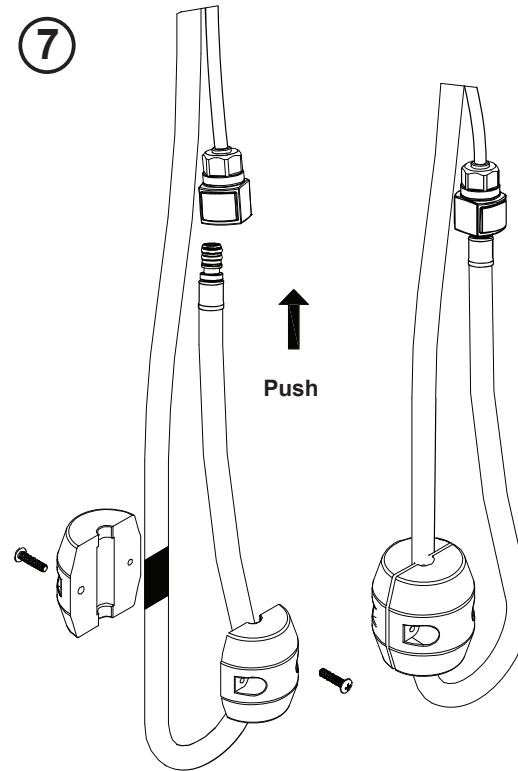

Install the spray hose to the outlet hoses. The outlet will connect with a simple push. Then attach the weight to the middle of the spray hose.

Turn the water valves back on and then turn on the faucet. Run the water flow for 15 seconds to clean up the lines and check for any leaks.

Test Faucet Installation

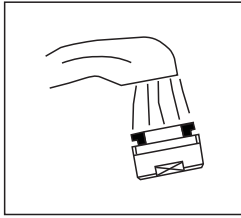

- A. Move handle into "OFF" position.
- B. Turn on water supplies. Check connections for leaks.
- C. Remove hand shower and let both hot and cold water run for one minute. This will help clean any debris that might otherwise clog the system. Replace hand shower.
- D. Operate handle up and down, in cold and hot positions, to flush water lines thoroughly.

Maintenance:

Simply rinse the surface with clear water or mild liquid detergents (if necessary) Dry the faucet with a clean soft cotton cloth. Do not use any cleaning agents containing acids, polish abrasives, or harsh cleaners.

Cleaning and care

Daily cleaning and care are required in order to keep the product shining and working properly.

1. Clean it with water and dry it with soft cloth.
2. Clean the product with gentle liquid or glass cleaner.
3. Don't use acid cleaner.
4. Don't clean with abrasive material, abrasive paper or knife.

Parts list

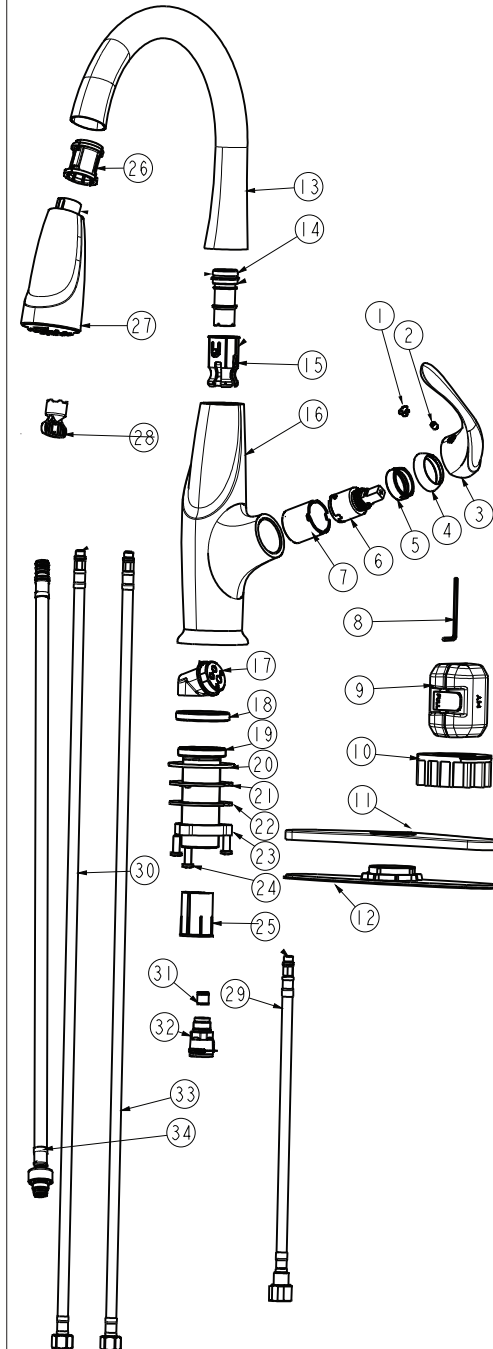

NO.	PART NAME
1	Index
2	Screw
3	Handle
4	Trim cap
5	Screw nut
6	Cartridge
7	Cartridge sleeve
8	Allen key
9	Weight
10	Quick connect base
11	Deck plate
12	Deck plate(baseboard)
13	Spout
14	Swivel connector
15	Anticlastic ring
16	Body
17	Cartridge base
18	Sleeve connector
19	Thread sleeve
20	O-ring
21	Washer
22	Gasket
23	Screw nut
24	Screw
25	Pull-out sleeve
26	Shower sleeve
27	Spray head
28	Aerator wrench
29	Inlet pipe
30	Supply line
31	Single valve
32	Quick connect components
33	Supply line
34	Pull out hose